

Document No. : SX-DSV03306

Revision No. : R13.0

Date of Issue : Mar. 1, 2024

Classification : New Change

Technical Reference

- Functional Specification -

Product Name : AC Servo Driver
Product Series Name : MINAS A6BL series
Product Model Number : EtherCAT communication/linear/DD type/VCM

Motion Control Business Unit, Industrial Device Business Division
Panasonic Industry Co., Ltd.

7-1-1 Morofuku, Daito—City, Osaka 574-0044, Japan

If you have any questions, please contact the seller (Sales office or Distributor) of the product.

Panasonic

この英文仕様書は、原本である和文仕様書を元にパナソニック インダストリー株式会社 モーションコントロールビジネスユニットが翻訳・発行するものです。翻訳は、原本の利用に際して一応の参考となるように便宜的に仮訳したものであり、公的な校閲を受けたものではありません。英語訳のみを使用して生じた不都合な事態に関しては、当社は一切責任を負うものではありません。和文仕様書のみが有効です。

パナソニック インダストリー株式会社
産業デバイス事業部 モーションコントロールビジネスユニット

This English specification is made and published by Motion Control Business Unit, Panasonic Industry Co., Ltd. based on the original Japanese specification. Translation is provided unofficially only for the sake of convenience of utilizing the original Japanese specification as a measure of reference. It is not officially reviewed. Motion Control Business Unit, Panasonic Industry Co., Ltd. is not liable for any disadvantages caused by utilizing only English specification. Only the Japanese specification is effective.

Motion Control Business Unit, Industrial Device Business Division,
Panasonic Industry Co., Ltd.

REVISIONS

Date	Page	Rev.	Contents	Signed
Jun.14, 2018	-	1.0	First edition	-
Oct.26, 2018	P1,2	2.0	Software upgrade CPU1 Ver1.04 → Ver1.05 CPU2 Ver1.04→ Ver1.05	-
	P1,2,8,164-170, 175		1) Function addition “Retracting operation function”	
	P2,103-105,133, 135,137		2) Function addition “Dealing with EtherCAT object extension” • Extension of torque limit function • Extension of velocity limit function under torque control	
	P4		• addition Added explanation about ESI	
Mar.20, 2019	P1,2,10-12	3.0	Software upgrade CPU1 Ver1.05 → Ver1.06 CPU2 Ver1.05→ Ver1.06	-
	P222		1) Function addition “Torque monitor value accuracy improvement”	
Apr.30, 2019	P1,3,10-12	4.0	Software upgrade CPU1 Ver1.06 → Ver1.07 CPU2 Ver1.06→ Ver1.07	-
	P3		1) Function addition “EtherCAT communication cycle 8ms, 10ms extension”	
	P11,124,136,164, 178,199,206,216		• Added the description • Corrected incorrect entries.	
	Overall		• Company name changed.	
Mar.27, 2020	P4	4.1	• Corrected incorrect entries.	-
May.12, 2020	P1,3,11-13	5.0	• Software upgrade CPU1 Ver1.07 → Ver1.08 CPU2 Ver1.07 → Ver1.08	-
	P141,142,144, 175,190,192,194, 224,225		1) Function addition “Specification extension of over-travel inhibition input”	
	P141,176		• Added notes	
Sep.14, 2020	P1,3,12-14	6.0	• Software upgrade CPU1 Ver1.08 → Ver1.09 CPU2 Ver1.08 → Ver1.09	-
	P12,60,225		1) Function addition 「Velocity limit priority function during torque control」	
	P225		2) Function addition 「Specification extension of Touch Probe function」	
	No changes to this document		3) Function addition 「Target position echo function」	
	P36,37,216		• Change: Changed the setting range of Pr4.16 and Pr4.18 to 0-30.	
	P4,12,13,17,34,35, 142,145,159,163,17 7,193,195,215, 225,227,228		• Added the description • Corrected incorrect entries.	
Jun. 1, 2021	P1,3,12-14	7.0	• Software upgrade CPU1 Ver1.09 → Ver1.10 CPU2 Ver1.09 → Ver1.10	-
	P6,26,27,29,30, 33,35,37,41,62,148, 162,170,175,179, 211,217-219,231		1) Function addition 「V frame supported」	

Note: The page number (Page) is the current page number at the time of revision.

Revisions

Date	Page	Rev.	Description	Signed
			(Continued from previous page)	
	P1,3,4,6,14,30,54, 65,67,93,144,177, 192,194,196,211, 219,222,226,234		<ul style="list-style-type: none"> • Added the description • Corrected incorrect entries. 	
	Overall		<ul style="list-style-type: none"> • Corrected all incorrect entries. • Company name changed. 	
Dec.1,2021	P1,3,12-14	8.0	<ul style="list-style-type: none"> • Software upgrade CPU1 Ver1.10 → Ver1.12 CPU2 Ver1.10 → Ver1.12 	-
	P230,231		<ul style="list-style-type: none"> • Improved EtherCAT communication compatibility Addition Added Pr7.24 bit15 (For manufacturer's use) Added Pr7.87 bit14-15 (For manufacturer's use) 	
	Overall		<ul style="list-style-type: none"> • Company name changed. • Corrected incorrect entries. 	
Apr.1,2022	-	8.1	<ul style="list-style-type: none"> • Changed the company name 	-
	-		<ul style="list-style-type: none"> • Changed the front cover format 	
Apr.28,2022	P1,3,12-14	11.0	<ul style="list-style-type: none"> • Software upgrade CPU1 Ver1.12 → Ver1.13 CPU2 Ver1.12 → Ver1.13 	-
	P3,231		<ul style="list-style-type: none"> 1) Function addition "Specification extension of Statusword" Addition Added Pr7.87 bit13 	
	P3		<ul style="list-style-type: none"> 2) Function addition "Extension of hm operation specification" • The origin returns using the mechanical end is supported. 	
	P221,223		<ul style="list-style-type: none"> • Addition Added Pr5.96 and Pr5.97 (For manufacturer's use) Added Pr6.25 and Pr6.26 (For manufacturer's use) 	
	P232		<ul style="list-style-type: none"> • Change Modified the name of Pr7.110 • Addition Added Pr7.110 bit7-8 	
	P187		<ul style="list-style-type: none"> • Addition Added the description about Err80.3 	
	P177,192		<ul style="list-style-type: none"> • Addition Added Err98.5 	
	Overall		<ul style="list-style-type: none"> • Corrected incorrect entries. 	
Mar.30,2023	P1,4,13-15	12.0	<ul style="list-style-type: none"> • Software upgrade CPU1 Ver1.13 → Ver1.14 CPU2 Ver1.13 → Ver1.14 	-
	P164,166,167,224		<ul style="list-style-type: none"> 1) Function addition "Position comparison function enhancement" Addition Added Pr5.94 	
	No change		<ul style="list-style-type: none"> 2) Function addition "Add axis specification information object" 	
	P181		<ul style="list-style-type: none"> 3) Function addition "Err27.7 Clearable Support" 	
	P1,2,12-15,19, 65,66,68-70,72 73,75,79,82,83, 85.143,188,237		<ul style="list-style-type: none"> 4) Function added, "voice coil motor (VCM) support" 	
	P225,234		<ul style="list-style-type: none"> • Addition Added Pr6.03,Pr7.78 and Pr7.80 	
	Overall		<ul style="list-style-type: none"> • Corrected incorrect entries. 	

Note: The page number (Page) is the current page number at the time of revision.

Contents

1. Introduction	1
1-1 Basic Specification.....	7
1-2 Function (Position control)	8
1-3 Function (Velocity control).....	9
1-4 Function (Torque control).....	10
1-5 Function (Common).....	11
1-6 Combined motor specification (for reference)	12
1-7 Main differences from the MINAS-A5BL series	13
2. Interface Specification.....	16
2-1 I/O connector input signal	16
2-2 I/O connector output signal	18
2-3 I/O connector other signal	21
2-3-1 Encoder output signal / Position comparison output signal	21
2-3-2 Others.....	21
2-4 signal allocation function	22
2-4-1 Input signal allocation.....	22
2-4-2 Assignment of output signal	27
3. Front panel display specification.....	30
3-1 Appearance of front panel.....	30
3-2 7 Segment LED, ALM and SRVON LED	31
3-2-1 7 Segment LED.....	31
3-2-2 ALM LED and SRVON LED.....	34
3-3 EtherCAT Indicators	35
1) RUN	37
2) ERR.....	37
3) L/A IN	37
4) L/A OUT.....	37
3-4 Monitor signal output function.....	38
3-5 Station alias	42
4. Basic function.....	43
4-1 Rotational direction setup	43
4-2 Position control	44
4-2-1 Process of command pulse input.....	44
4-2-2 Electronic gear function.....	45
4-2-3 Positional command filtering function.....	49
4-2-4 Positioning complete output (INP/INP2) function.....	51
4-2-5 Pulse regeneration function.....	53
4-3 Velocity control.....	56
4-3-1 Attained speed output (AT-SPEED)	57
4-3-2 Speed coincidence output (V-COIN).....	58
4-3-3 Velocity command acceleration/deceleration setting function	59
4-4 Torque control.....	61
4-4-1 Speed limit function.....	62
4-5 Setting regenerative resistor	63
4-6 Absolute setup.....	64
4-6-1 Feedback scale	64
4-6-1-1 Structure of absolute system.....	64

4-7 Linear motor/feedback scale setting	65
4-7-1 Parameter setting according to linear motor/feedback scale specification	66
4-7-1-1 Linear type motor	66
4-7-1-2 Rotary type motor	68
4-7-1-3 Linear type motor	69
4-7-1-4 Feedback scale type setting	70
4-7-1-5 Manual direction setting of feedback scale	72
4-7-2 Current gain setting	73
4-7-3 Pole position detection method setting	75
4-7-3-1 CS signal method	75
4-7-3-2 Pole position estimation method	79
4-7-3-3 Pole position recovery method	82
4-7-4 Automatic linear motor setting with tool	83
5. Gain tuning/vibration suppressing function	86
5-1 Automatic adjusting function	86
5-1-1 Real-Time Auto Tuning	87
5-1-2 Adaptive filter	95
5-1-3 Real-time Auto Tuning (Two-degree-of-Freedom control mode Standard type)	98
5-2 Manual adjusting function	106
5-2-1 Block diagram of position control mode	107
5-2-2 Block diagram of velocity control mode	108
5-2-3 Block diagram of torque control mode	109
5-2-4 Gain Switching Function	110
5-2-5 Notch filter	116
5-2-6 Damping Control	118
5-2-7 Model-type damping filter	123
5-2-8 Feed forward function	127
5-2-9 Load variation suppression function	129
5-2-10 3rd gain switching function	132
5-2-11 Friction torque compensation	133
5-2-12 Two-stage torque filter	135
5-2-13 Quadrant projection suppression function	136
5-2-14 Two-degree-of-freedom control mode (with position control)	137
5-2-15 Two-degree-of-freedom control mode (with velocity control)	140
5-2-16 Two-degree-of-freedom control mode (with torque control)	142
6. Application	143
6-1 Torque limit switching function	143
6-2 Motor working range setup function	144
6-3 Deceleration stop sequence	147
6-3-1 Sequence upon inputting of over-travel inhibition (POT, NOT)	147
6-3-2 Sequence at Servo-Off	151
6-3-3 Sequence at main power OFF	152
6-3-4 Sequence at alarm	154
6-3-5 Emergency stop upon occurrence of alarm	156
6-3-6 Fall prevention function in the event of alarms/Servo-ON	158
6-3-6-1 Fall prevention function in the event of alarms	158
6-3-6-2 Fall prevention function in the event of Servo-ON	159
6-3-7 Slow stop function	160
6-4 Torque saturation protection function	164
6-5 Position comparison output function	165
6-6 Deterioration diagnosis warning function	170
6-7 Retracting operation function	173

7. Protective function/Alarm function	180
7-1 List of protective function	180
7-2 Details of Protective function.....	184
7-3 Warning function	199
7-4 Setup of gain pre-adjustment protection	203
7-5 About the protection function setting for homing return by using the Z phase	206
8. Safety function	208
8-1 Outline of safe torque off (STO) function.....	208
8-2 Input/output signal specification	209
8-2-1 Safety input signal	209
8-2-2 External device monitor (EDM) output signal.....	210
8-3 Description of functions	211
8-3-1 Activation to STO state, timing diagram	211
8-3-2 Return timing diagram from STO state.....	212
8-4 Connection example.....	213
8-4-1 Example of connection to safety switch	213
8-4-2 Example of connection when using multiple axes	214
8-5 Safety precautions	215
9. Other.....	216
9-1 List of parameters.....	216
9-1-1 Class 0: Basic setting	216
9-1-2 Class 1: Gain adjustment	217
9-1-3 Class 2: Damping control	219
9-1-4 Class 3: Velocity/ Torque/ Scale.....	221
9-1-5 Class 4: I/O monitor setting	222
9-1-6 Class 5: Enhancing setting	225
9-1-7 Class 6: Special setting	229
9-1-8 Class 7: Special setting 2	235
9-1-9 Class 8: Special setting 3	241
9-1-10 Class 9: Linear-related	242
9-1-11 Class 15: For manufacturer's use.....	244
9-2 Timing Chart	245
9-2-1 Servo-on signal accept timing on power-up : When magnet pole position estimation is invalid (Pr9.20=2)	245
9-2-2 Servo-on signal accept timing on power-up: When magnet pole position estimation is invalid (Pr 9.20 = 0, 1, 3)...	247
9-2-3 Servo-ON/OFF action while the motor is at stall (servo-lock)	249
9-2-4 Servo-ON/OFF action while the motor is in motion.....	250
9-2-5 When an error (alarm) has occurred (at Servo-ON command) (DB/Free run deceleration movement)	251
9-2-6 When an error (alarm) has occurred (at Servo-ON command) (Emergency stop movement).....	252
9-2-7 When an alarm has been cleared (at Servo-ON command)	253

1. Introduction

This document describes the functions of the servo driver MINAS-A6BL series(A6BL/A6BM).

<MINAS-A6BL series Functional comparison>

* In this software version, The functions of “×” are not supported in the table below.

○:Usable ×:Not usable

Function		Product	[A6BL] Linear/DD/VCM drive (Standard type) Product number ending with:L CPU1:Ver1.15 CPU2:Ver1.15	[A6BM] Linear/DD/VCM drive (Multi-function type) Product number ending with:M CPU1:Ver1.15 CPU2:Ver1.15
Control mode	Position control(pp)		○	○
	Position control(csp)		○	○
	Position control(ip)		×	×
	Position control(hm)		○	○
	Velocity control(pv)		○	○
	Velocity control(csv)		○	○
	Torque control(tq)		○	○
	Torque control(cst)		○	○
	Torque control(cstca)		×	×
Function	Two-degree-of-freedom control(Position)		○	○
	Two-degree-of-freedom control(Velocity)		○	○
	Two-degree-of-freedom control(Torque)		○	○
	Safety function		×	○
	Vibration control		○	○
	Model type damping filter		○	○
	Feed forward function		○	○
	Load change suppression control		○	○
	Third gain switching function		○	○
	Friction torque compensation		○	○
	Quadrant projection suppressionfunction		○	○
	Torque limit switching function		○	○
	Motor movable range setting function		○	○
	Torque saturation protection function		○	○
	Slow stop function		○	○
	Deterioration diagnosis warning function		○	○
	Retracting operation function		○	○
	Position comparison output function		○	○
	FoE(File Access over EtherCAT)		×	×
	Jerk		×	×
Complete Access of SDO message		×	×	

- Some functions cannot be used in [A6BL].

Where applicable, these items are indicated with “Cannot be used in [A6BL]” in the descriptions contained in this reference for your confirmation.

*1) It is not supported in two-degree-of-freedom control (synchronization type).

<Supported motor types>

This series supports driving linear motors, DD (direct drive) motors, and VCMs (voice coil motors).

Motor type	Linear motor/ VCM (voice coil motors)	DD (Direct drive) motor
Division in this reference	Linear type / Linear (VCM)	Rotary type
Related terms	Mass (Unit: kg)	Inertia (Unit: kgm ²)
	Thrust (Unit: N)	Torque (Unit: Nm)
	mm/s	r/min
	Operation	Rotation

On this document, the description of terms are based on “Rotary type.”

When a “linear” or “linear (VCM)” type is used, interpret them as shown in the table above.

<Software version>

This technical reference applies to the servo drivers compatible with software of the following version:

* Check the software versions 1 and 2 by 3744h (Reference to section 5-2 of EtherCAT communication specification) or setup support software PANATERM.

* Check the software version 3 by 100Ah(Reference to section 5-2 of EtherCAT communication specification).

Software version	Contents of function change		Available PANATERM
CPU1(Version1) Ver1.04 CPU2(Version2) Ver1.04 Manufacture Software (Version3) Ver1.00	First edition		6.0.1.11 or later
	Additional capability	Reference	
	1) Voice coil motor (VCM) support	This document 1,1-6,1-7,2-2,4-7,4-7-1, 4-7-1-3,4-7-2,4-7-3,4-7-4, 6-2,7-2,9-1-10 EtherCAT Communication Specification 1	
CPU1(Version1) Ver1.05 CPU2(Version2) Ver1.05 Manufacture Software (Version3) Ver1.00	Function extended edition 1		6.0.1.13 or later
	Additional capability	Reference	
	2) Retracting operation function Support for retracting operation	This document 6-7,9	
3) Dealing with EtherCAT object extension • Extension of torque limit function • Extension of velocity limit function under torque control	This document 6-1, EtherCAT Communication Specification 6-4,6-6,6-7,6-8,9		
CPU1(Version1) Ver1.06 CPU2(Version2) Ver1.06 Manufacture Software (Version3) Ver1.00	Function extended edition 2		6.0.1.15 or later
	Additional capability	Reference	
	1) Torque monitor value accuracy improvement	This document 9-1 EtherCAT Communication Specification 9	

Software version	Contents of function change		Available PANATERM
CPU1(Version1) Ver1.07 CPU2(Version2) Ver1.07 Manufacture Software (Version3) Ver1.00	Function extended edition 3		6.0.1.15 or later
	Additional capability	Reference	
	1) EtherCAT communication cycle 8ms, 10ms extension	This document 1 EtherCAT Communication Specification 1,1-2,2-4,5-5,5-5-1,5-5-3,8-2	
CPU1(Version 1) Ver1.08 CPU2(Version 2) Ver1.08 Manufacture Software (Version 3) Ver1.00	Function extended edition 4		6.0.1.15 or later
	Additional capability	Reference	
	1) Specification extension of over-travel inhibition input	This document 6-3-1,7-1,7-2,7-3,9-1 EtherCAT communication specification 3-6-1,6-9-2,8-1,8-3,9	
CPU1(Version 1) Ver1.09 CPU2(Version 2) Ver1.09 Manufacture Software (Version 3) Ver1.00	Function extended edition 5		6.0.1.21 or later
	Additional capability	Reference	
	1) Velocity limit priority function during torque control	This document 4-4-1,9-1 EtherCAT communication specification 6-8-3	
	2) Specification extension of Touch Probe function	This document 9-1 EtherCAT communication specification 6-9-1,8-1,9	
	3) Target position echo function	This document No change EtherCAT communication specification 6-6-1,9	
CPU1(Version 1) Ver1.10 CPU2(Version 2) Ver1.10 Manufacture Software (Version 3) Ver1.00	Function extended edition 6		6.0.3.0 or later
	Additional capability	Reference	
	1) Expansion of V frame supported	This document 1-1,2-4-2,3-1,3-2-1,3-2-2, 3-4,4-5,6-3-3,6-5,6-7,7-1, 9-1-1,9-1-5,9-1-6,9-1-8 EtherCAT communication specification 3-8,3-8-1	
CPU1(Version1) Ver1.12 CPU2(Version2) Ver1.12 Manufacture Software (Version3) Ver1.00	Function extended edition 7		6.0.4.1 or later
	Additional capability	Reference	
	1) Improved EtherCAT communication compatibility	This document 9-1 EtherCAT communication specification No change	
CPU1(Version1) Ver1.13 CPU2(Version2) Ver1.13 Manufacture Software (Version3) Ver1.00	Function extended edition 8		6.0.6.0 or later
	Additional capability	Reference	
	1) Specification extension of Statusword	This document 9-1-8 EtherCAT communication specification 6-6-3	
	2) Extension of hm operation specification	This document No change EtherCAT communication specification 6-6-5, 9-4	

Software version	Contents of function change	Available PANATERM								
CPU1(Version1) Ver1.14 CPU2(Version2) Ver1.14 Manufacture Software (Version3) Ver1.00	<table border="1"> <thead> <tr> <th data-bbox="499 286 858 320">Additional capability</th> <th data-bbox="858 286 1289 320">Reference</th> </tr> </thead> <tbody> <tr> <td data-bbox="499 320 858 450">1) Position comparison function enhancement</td> <td data-bbox="858 320 1289 450"> This document 6-5,9-1-6 EtherCAT communication specification 6-9-3,9-3-6 </td> </tr> <tr> <td data-bbox="499 450 858 580">2) Add axis specification information object</td> <td data-bbox="858 450 1289 580"> This document No change EtherCAT communication specification 9-2 </td> </tr> <tr> <td data-bbox="499 580 858 710">3) Err27.7 Clearable Support</td> <td data-bbox="858 580 1289 710"> This document 7-1 EtherCAT communication specification 8-1 </td> </tr> </tbody> </table>	Additional capability	Reference	1) Position comparison function enhancement	This document 6-5,9-1-6 EtherCAT communication specification 6-9-3,9-3-6	2) Add axis specification information object	This document No change EtherCAT communication specification 9-2	3) Err27.7 Clearable Support	This document 7-1 EtherCAT communication specification 8-1	6.0.8.0 or later
	Additional capability	Reference								
	1) Position comparison function enhancement	This document 6-5,9-1-6 EtherCAT communication specification 6-9-3,9-3-6								
	2) Add axis specification information object	This document No change EtherCAT communication specification 9-2								
3) Err27.7 Clearable Support	This document 7-1 EtherCAT communication specification 8-1									
CPU1(Version1) Ver1.15 CPU2(Version2) Ver1.15 Manufacture Software (Version3) Ver1.00	<table border="1"> <thead> <tr> <th data-bbox="499 768 858 801">Additional capability</th> <th data-bbox="858 768 1289 801">Reference</th> </tr> </thead> <tbody> <tr> <td data-bbox="499 801 858 931">1) Extended configuration for 6041h bit12(homing attained)</td> <td data-bbox="858 801 1289 931"> This document 9-1-8 EtherCAT communication specification 6-6-5 </td> </tr> <tr> <td data-bbox="499 931 858 1061">2) Inertia ratio extended</td> <td data-bbox="858 931 1289 1061"> This document 5-1-1,5-1-3,9-1-1 EtherCAT communication specification 9-3-1 </td> </tr> </tbody> </table>	Additional capability	Reference	1) Extended configuration for 6041h bit12(homing attained)	This document 9-1-8 EtherCAT communication specification 6-6-5	2) Inertia ratio extended	This document 5-1-1,5-1-3,9-1-1 EtherCAT communication specification 9-3-1	6.0.10.0 or later		
	Additional capability	Reference								
	1) Extended configuration for 6041h bit12(homing attained)	This document 9-1-8 EtherCAT communication specification 6-6-5								
2) Inertia ratio extended	This document 5-1-1,5-1-3,9-1-1 EtherCAT communication specification 9-3-1									

<Software Notice>

This product contains Open Source Software (OSS) and is used under the following license terms.

Your company may be obliged to use OSS, so please take appropriate measures.

Copyright (c) 2011, Texas Instruments Incorporated
All rights reserved.

Redistribution and use in source and binary forms, with or without modification, are permitted provided that the following conditions are met:

- * Redistributions of source code must retain the above copyright notice, this list of conditions and the following disclaimer.
- * Redistributions in binary form must reproduce the above copyright notice, this list of conditions and the following disclaimer in the documentation and/or other materials provided with the distribution.
- * Neither the name of Texas Instruments Incorporated nor the names of its contributors may be used to endorse or promote products derived from this software without specific prior written permission.

THIS SOFTWARE IS PROVIDED BY THE COPYRIGHT HOLDERS AND CONTRIBUTORS "AS IS" AND ANY EXPRESS OR IMPLIED WARRANTIES, INCLUDING, BUT NOT LIMITED TO, THE IMPLIED WARRANTIES OF MERCHANTABILITY AND FITNESS FOR A PARTICULAR PURPOSE ARE DISCLAIMED. IN NO EVENT SHALL THE COPYRIGHT OWNER OR CONTRIBUTORS BE LIABLE FOR ANY DIRECT, INDIRECT, INCIDENTAL, SPECIAL, EXEMPLARY, OR CONSEQUENTIAL DAMAGES (INCLUDING, BUT NOT LIMITED TO, PROCUREMENT OF SUBSTITUTE GOODS OR SERVICES; LOSS OF USE, DATA, OR PROFITS; OR BUSINESS INTERRUPTION) HOWEVER CAUSED AND ON ANY THEORY OF LIABILITY, WHETHER IN CONTRACT, STRICT LIABILITY, OR TORT (INCLUDING NEGLIGENCE OR OTHERWISE) ARISING IN ANY WAY OUT OF THE USE OF THIS SOFTWARE, EVEN IF ADVISED OF THE POSSIBILITY OF SUCH DAMAGE.

< Related data >

SX-DSV03190 : Standard specifications(A6BL Series, other than V frame)

SX-DSV03510 : Standard specifications (A6BL series V frame)

(The specification about hardware, Safety Precautions, Warranty etc. is indicated. Please be sure to read carefully, after understanding the contents, refer to this specification.)

SX-DSV03307 : Technical Reference (EtherCAT communication specification)

<IMPORTANT>

- (1) All rights reserved. No part of this publication may be reproduced or transmitted in any form without prior permission.
- (2) Motion Control Business Unit, Panasonic Industry Co., Ltd. reserves the right to make modifications and improvements to its products and/or documentation, including specifications and software, without prior notice.
- (3) For MINAS-A6BL series, the shipment setting value was changed from the previous series(MINAS-A5BL series, etc.) by enabling "2 degrees of freedom control mode", etc.
Note that the parameters need to be adjusted again if replacing with MINAS-A6BL series from the previous series.
See the Standard specifications for the shipment setting value of the MINAS-A6BL series.
- (4) See Section 1-2 "Main differences from MINAS-A5BL series" in technical document - EtherCAT communication specification (SX-DSV03307) for differences from the MINAS-A5BL series.
- (5) MINAS-A6BL series may not be fully compatible operation with the previous series(MINAS-A5BL series).
In the case of replacing the previous series to MINAS-A6BL series, be sure to evaluate.
- (6) See the Standard specifications for the product number of servo driver that passed the EtherCAT Conformance Test.

EtherCAT® is registered trademark and patented technology,
licensed by Beckhoff Automation GmbH, Germany.

EtherCAT®
Conformance tested



1-1 Basic Specification

Item		Contents																				
Control method		Other than V frame : IGBT PWM method, sinusoidal drive V frame : MOSFET PWM method, sinusoidal drive																				
Control mode		<table border="1"> <thead> <tr> <th colspan="3">Modes of operation</th> </tr> </thead> <tbody> <tr> <td rowspan="3">Position</td> <td>pp</td> <td>Profile position mode (Profile position control mode)</td> </tr> <tr> <td>csp</td> <td>Cyclic synchronous position mode (Cyclic position control mode)</td> </tr> <tr> <td>hm</td> <td>Homing mode (Origin return position control mode)</td> </tr> <tr> <td rowspan="2">Speed</td> <td>pv</td> <td>Profile velocity mode (Profile speed control mode)</td> </tr> <tr> <td>csv</td> <td>Cyclic synchronous velocity mode (Cyclic speed control mode)</td> </tr> <tr> <td rowspan="2">Torque</td> <td>tq</td> <td>Torque profile mode (Profile torque control mode)</td> </tr> <tr> <td>cst</td> <td>Cyclic synchronous torque mode (Cyclic torque control mode)</td> </tr> </tbody> </table>	Modes of operation			Position	pp	Profile position mode (Profile position control mode)	csp	Cyclic synchronous position mode (Cyclic position control mode)	hm	Homing mode (Origin return position control mode)	Speed	pv	Profile velocity mode (Profile speed control mode)	csv	Cyclic synchronous velocity mode (Cyclic speed control mode)	Torque	tq	Torque profile mode (Profile torque control mode)	cst	Cyclic synchronous torque mode (Cyclic torque control mode)
Modes of operation																						
Position	pp	Profile position mode (Profile position control mode)																				
	csp	Cyclic synchronous position mode (Cyclic position control mode)																				
	hm	Homing mode (Origin return position control mode)																				
Speed	pv	Profile velocity mode (Profile speed control mode)																				
	csv	Cyclic synchronous velocity mode (Cyclic speed control mode)																				
Torque	tq	Torque profile mode (Profile torque control mode)																				
	cst	Cyclic synchronous torque mode (Cyclic torque control mode)																				
Feedback scale		A/B phase/origin signal differential input type Serial communications type (Incremental specification, Absolute linear specification, and Absolute rotary specification)*1																				
Pole detection signal		CS signal (CS1, CS2, CS3), or pole position estimation (CS signal unnecessary) - Changeable with a parameter																				
Control signal	Input	Each 8 input can be assigned by the parameter.																				
	Output	Other than V frame : Each 3 output can be assigned by the parameter. V frame : Assignment possible at 2 points (function assignment by parameter), alarm signal output 1 point.																				
Analogue signal	Output	2 outputs for analog monitors 1 and 2 Cannot be used with [V frame].																				
Pulse signal	Output	Feedback scale pulse is output to the line driver with the A/B phase signal.																				
Communi- cation	EtherCAT	Communication for transmission of a real-time operation command, the parameter setting, or the status monitoring.																				
	USB	USB interface to connect to computers (setup support software PANATERM) for parameter setting or status monitoring. USB cable connection is possible.																				
Safety terminal		Terminal to support safety function. *2																				
Front panel		1. 7-segment LED (double digits) *3 2. Network status LED (LINK, COM) 3. Rotary switch for node address setting 4. Analog monitor output (Analog monitors 1 and 2) *3 5. ALM LED and SRVON LED *4																				
Regeneration		Frame size A and B: Without built-in regenerative resistor (use external resistor) Frame size C-F: Built-in regenerative resistor (External regenerative resistor is also available) V frame: No built-in regenerative resistor (external addition not possible)																				
Dynamic brake		For information on the built-in type, refer to the Standard specifications.																				

*1: Please contact us for a corresponding part number.

*2: Available for [A6BM] only. It cannot be used in [A6BL].

*3: Cannot be used with [V frame].

*4: Can be used only with [V frame].

1-2 Function (Position control)

Item		Contents	
Position control	Control input	Positive direction drive inhibit, negative direction drive inhibit, latch signal, near home position, etc.	
	Control output	Positioning completion etc.	
	Position command input	Input mode	Command type by EtherCAT command
		Smoothing Filter	Either a primary delay filter or a FIR type filter can be selected against command input.
	Damping control	Available (Up to 3 frequency settings, out of 4 settings in total, can be used simultaneously.)	
	Model type damping filter	Available (2 filters available) [Requirement] 2 degrees of freedom control is enabled.	
	Feed forward function	Available (speed/torque)	
	Load variation suppression function	Available [Requirement] Servo-on. No hindrance for the motor's normal run.	
	Gain 3 switching function	Available [Requirement] Servo-on. No hindrance for the motor's normal run.	
	Friction torque compensation	Available [Requirement] Servo-on. No hindrance for the motor's normal run.	
	Quadrant projection suppression function	Available [Requirement] Servo-on. No hindrance for the motor's normal run.	
	Two-degree-of-freedom control mode	Available (standard) [Requirement] Servo-on. No hindrance for the motor's normal run.	
	Torque limit switching function	Available [Requirement] Servo-on. No hindrance for the motor's normal run.	
	Motor operatable setup function	Available [Requirement] Servo-on. No hindrance for the motor's normal run.	
Torque saturation protection function	Available		

1-3 Function (Velocity control)

Item		Contents	
Control input		Positive direction drive inhibit, negative direction drive inhibit, latch signal, etc.	
Control output		At speed etc.	
Velocity command input	Input mode	Command type by EtherCAT command	
Soft start/slowdown function		0 – 10 s / 1000 r/min Acceleration and deceleration can be set separately. S-curve acceleration/deceleration is also available.	
Damping control		Not available	
Model type damping filter		Not available	
Velocity control	Feed forward function		Available (torque)
	Load variation suppression function		Available [Requirement] Servo-on. No hindrance for the motor's normal run.
	Gain 3 switching function		Not available
	Friction torque compensation		Available [Requirement] Servo-on. No hindrance for the motor's normal run.
	Quadrant projection suppression function		Not available
	Two-degree-of-freedom control mode		Available (standard) [Requirement] Servo-on. No hindrance for the motor's normal run.
	Torque limit switching function		Available [Requirement] Servo-on. No hindrance for the motor's normal run.
	Motor operatable setup function		Not available
	Torque saturation protection function		Available

1-4 Function (Torque control)

Item		Contents	
Torque control	Control input	Positive direction drive inhibit, negative direction drive inhibit, latch signal, etc.	
	Control output	At speed etc.	
	Torque command input	Input mode	Command type by EtherCAT command
	Speed limit function	Speed limit value can be set by parameter. (Switched by EtherCAT command.)	
	Damping control	Not available	
	Model type damping filter	Not available	
	Feed forward function	Not available	
	Load variation suppression function	Not available	
	Gain 3 switching function	Not available	
	Friction torque compensation	Not available	
	Quadrant projection suppression function	Not available	
	Two-degree-of-freedom control mode	Configurable	
	Torque limit switching function	Not available	
	Motor operatable setup function	Not available	
	Torque saturation protection function	Not available	

1-5 Function (Common)

	Item	Contents
Common	Electronic gear ratio	Applicable scaling ratio: 1/1000–8000
	Auto-tuning	Identifies the load inertia real-time and automatically sets up the gain that meets the stiffness setting when the motor is running with upper and internal operation commands.
	Notch filter	Available (5 filters available)
	Gain switching function	Available
	2-step torque filter	Available [Requirement] Servo-on. No hindrance for the motor's normal operation.
	Position comparison output function	Available [Requirement] EtherCAT communication is established. No hindrance for the motor's normal run. In the case of serial incremental feedback scale, home position return must be completed.
	Protective function	Overvoltage, undervoltage, overspeed, overload, overheat, overcurrent, encoder failure, positional overdeviaition, EEPROM failure, etc.
	Alarm data trace back	Tracing back of alarm data is available
	Deterioration diagnosis function	Available
	Retracting operation function	Available

1-6 Combined motor specification (for reference)

Motor	Linear type / Linear (VCM)	Rotary type
Magnetic pole	Pitch: 1 to 300 mm *4 *8	Number of pole pairs per revolution: 1 to 64 *4
Max/rated current ratio	0 to 500%	
M/F ratio (J/T ratio)	M/F ratio: 0.0005 to 0.3 [kg/N]	J/T ratio: 0.000005 to 0.003 [kgm ² /Nm]
Electrical time constant (for reference) *1	Carrier 6 kHz: 1 ms or more, 8 kHz: 0.8 ms or more, 12 kHz: 0.5 ms or more	
Acceptable speed	Electrical angle frequency: Up to 500 Hz *8	

Feedback scale	Linear type / Linear (VCM)	Rotary type
Resolution	0.001 to 10 [μ m/pulse] *4	10000 to 2 ²⁹ [pulse/r] *4 *7
Maximum length	Up to resolution x (2 ³⁰ - 1)	—
Scale type	<ul style="list-style-type: none"> • A/B phase, differential origin signal input type • Serial communication type (incremental specification and Absolute linear specification) 	<ul style="list-style-type: none"> • A/B phase, differential origin signal input type • Serial communication type (incremental specification and Absolute rotary specification)
Acceptable scale speed *2	<ul style="list-style-type: none"> • A/B phase, differential origin signal input type: Up to 4M [pulse/s]*6 • Serial communication type: Up to 4000 M [pulse/s] *5 	<ul style="list-style-type: none"> • A/B phase, differential origin signal input type: Up to 4M [pulse/s]*6 • Serial communication type: Up to 1000 M [pulse/s]

*1 These figures are for reference only. Decide whether to apply the data by evaluating actual combination. (Noise, motor heating, etc.)

*2 This is an available speed on the driver. For information on the supported speed on the scale side, refer to the scale specifications separately.

*3 For more information on various specifications, also refer to “4-7 Linear motor/feedback scale setting”.

*4 The number of pulses should be 2048 or more per magnetic pole pitch (per electric angle cycle).

*5 In case of velocity control mode or torque control mode, it is up to 2100M [pulse/s].

*6 For information on acceptable scale speed over 4 Mpps, contact us.

*7 Regarding resolution of the serial communication type (absolute rotary specification), if it exceeds 2²⁴[pulse/r], only 2ⁿ (2²⁵, 2²⁶, etc.) [pulse/r] are supported.

*8 Linear (VCM) types are out of the scope.

1-7 Main differences from the MINAS-A5BL series

There are mainly the following differences in specifications when comparing the MINAS-A6BL series with the MINAS-A5BL series. Please inquire about specification differences other than the below.

<SX-DSV03306 : Technical document (Basic function specifications)>

Chapter	Function	Contents	A5BL specification	A6B specification	A6BL specification (Linear/DD/VCM drive)
			Ver8.01	[A6BF] (Multi-function type) CPU1 : Ver1.15,CPU2 : Ver1.15	[A6BM] (Multi-function type) [A6BL] (Standard type) CPU1 : Ver1.15,CPU2 : Ver1.15
2-1 2-4-1	Input signal	Retracting operation input (RET)	Not supported	Supported	Not Supported
2-2	Output signal function	Position comparison output "CMP-OUT"	Not supported	Supported	Supported
		Deterioration diagnosis velocity output "V-DIAG"	Not supported	Supported	Supported
2-4-2	Assignment of output signal	Estimated pole position output (CS-CMP) Setup value	12h	Not Supported	16h
3-2	7-segment LED	Station Alias display 3700h(Display on LED)=4 (Station alias setting value) display setting	The setting value of RSW of the front panel is displayed regardless of 3741h (Station Alias selection).	The value to be displayed varies depending on the setting value of 3741h (Station Alias selection). 3741h = 0: Value of RSW of the front panel 3741h = 1: Value of Low byte of SII area(0004h)	
3-4	Monitor signal output function	Analog monitor Unit of command position deviation	Encoder unit (No reflection of 607Eh (Polarity))	Command unit (607Eh (Polarity) is reflected.)	
4-2-4	Positioning complete output (INP/INP2) function	Position setup unit select 3520h(Position setup unit select)	Not supported 3520h = 1 fixed (encoder unit)	Supported 3520h = 0 : command unit 3520h = 1 : encoder unit(external scale)	Supported 3520h = 0 : command unit 3520h = 1 : feedback scale unit
4-2 4-3 4-4 4-5	Torque offset filter (Pr7.113)	1st delay filter for 60B2h (Torque offset)	Not supported	Supported	
4-2-5	Pulse regeneration function	Function for transmitting the movement amount to the host controller with AB pulse	Not supported	Supported	
4-4-1	Speed limit function	Addition of a velocity limit priority function during torque control	Not supported	Supported	
-	Full-closed control	Support for the full-closed system with external scale	Not supported	supported	Not Supported
-	External scale position information monitor function under semi-closed control	Function that monitors external scale position information via EtherCAT communication even under semi-closed control	Not supported	supported	Not Supported
4-7	Linear motor/feedback scale setting	Linear (VCM)	Not supported	Not supported	Supported (Pr9.00=3)
5-2-9	Load variation suppression function	Function for suppressing fluctuation of motor speed caused by disturbance torque and load fluctuation and improving stability	Not supported	Supported	
-	Hybrid vibration damping function	Function that suppresses the vibration resulting from the amount of torsion of the motor and the load in the full-closed control mode	Not supported	supported	Not Supported
5-2-13	Quadrant projection suppression function	Control configuration that suppresses quadrant projection occurring during arc interpolation of 2 or more axes	Not supported	Supported	
5-2-14 5-2-15 5-2-16	Two-degree-of-freedom control mode	2 degrees of freedom control shipment setting condition Shipment value of 3647h (Function expansion setup 2)	2 degrees of freedom control Disabled (Shipment value 0)	2 degrees of freedom control Enabled (Shipment value 1)	
		Control mode in 2 degrees of freedom control	Position control mode	• 2 degrees of freedom control (standard type) Position control mode, Velocity control mode • 2 degrees of freedom control (synchronization type) Position control mode	• 2 degrees of freedom control (standard type) Position control mode, Velocity control mode Torque control mode

(To be continued)

<SX-DSV03306 : Technical document (Basic function specifications)>

Chapter	Function	Contents	A5BL specification	A6B specification	A6BL specification (Linear/DD/VCM drive)
			Ver8.01	[A6BF] (Multi-function type) CPU1 : Ver1.15,CPU2 : Ver1.15	[A6BM] (Multi-function type) [A6BL] (Standard type) CPU1 : Ver1.15,CPU2 : Ver1.15
-	High response current control	Function to improve the responsiveness of the current control part	Not supported	Supported	Not supported
6-3-6-2	Fall prevention function in the event of Servo-ON	Internal value state selection of 60B2h (Torque offset) switching bit in servo-off (fall prevention function in the event of Servo-ON)	Switching with 3724h bit10	Switching with 3724h bit7	
6-5	Position comparison output function	Function that enables a general-purpose output or encoder output terminal to output a pulse signal when the actual position passes the position set for the parameter	Not supported	Supported	
-	Continuous rotating absolute encoder function	Function that enables setting of the upper limit value for the absolute encoder multi-turn data arbitrarily	Not supported	Supported	Not Supported
6-6	Deterioration diagnosis warning function	Function that checks the changes in motor and connected equipment characteristics to output deterioration diagnosis warning.	Not supported	Supported	
6-7	Retracting operation function	Function that performs an retracting operation at the speed and movement amount set up by the relevant parameters when one of the retracting operation activation conditions is established	Not supported	Supported	Supported
-	Backlash compensation function	Function that backlash compensation and the specification extension of backlash compensation	Not supported	Supported	Not Supported
7-1	List of protective function	Err16.1 (Torque saturation error protection) Occurrence factor	Torque saturated is continued for the value set for Pr7.16 "Torque saturation error protection times".	Torque saturated is continued for the time set for Pr7.16 "Torque saturation error protection times" or Pr6.57 "Torque saturation error protection time".	
7-2	Details of Protective function	Err27.4(Position command error protection) clear attribute	Not clearable	Clearable	
		Err27.7 (Position information initialization error protection)	Not supported	Supported	
		Err87.1 (Retracting operation completion (I/O))	Not supported	Supported	
		Err87.3(Retracting operation error)	Not supported	Supported	
		Err88.1 (Control mode setting error protection) Occurrence factor	The mode other than position control is set for 6060h (Modes of operation) while in 2 degrees freedom control mode.	<ul style="list-style-type: none"> 6060h (Modes of operation) 3(pv) or 9(csv) is set up under 2 degrees of freedom control mode (synchronization type). 2 degrees of freedom control mode (synchronous type) was set when under full-closed control. 	Alarm does not occur
		Err88.2 (ESM requirements during operation error protection) Occurrence factor	When the ESM state received a transition command to other ESM states with the PDS state at "Operation enabled" or "Quick stop active".	<ul style="list-style-type: none"> When the ESM state received a transition command to other ESM states with the PDS state at "Operation enabled" or "Quick stop active". When 3799 bit0=1 is set, the command for transiting from the current ESM to other ESM state is received during servo-on (while warning D2 is occurring) on PANATERM. 	
		Err91.1 (Command error protection) Occurrence factor	Control mode was switched at intervals shorter than 2ms.	<ul style="list-style-type: none"> Communication cycle was set to 0.125 ms under semi-closed control while the external scale position information monitor function is valid. Communication cycle was set to 0.250 ms or 0.125 ms under full-closed control and DC synchronous mode or SM2 synchronous mode. A position where it cannot shift to infinite turn absolute mode (outside the range for Position range limit (607Bh)) was set as the target position. 	Alarm does not occur.
Err93.5 (Parameter setting error protection 4) Occurrence factor	Not supported	Supported			

(To be continued)

<SX-DSV03306 : Technical document (Basic function specifications)>

Chapter	Function	Contents	A5BL specification	A6B specification	A6BL specification (Linear/DD/VCM drive)
			Ver8.01	[A6BF] (Multi-function type) CPU1 : Ver1.15,CPU2 : Ver1.15	[A6BM] (Multi-function type) [A6BL] (Standard type) CPU1 : Ver1.15,CPU2 : Ver1.15
7-3	Warning function	Warning latch state setup function 3627h(Warning latch state setup)	Not supported 3627h is fixed at 3. (Both extended warning and general warning are latched.)	Supported	
		Over-load warning detection level and Over-load warning release level	A5B:Not supported A5BL:supported Over-load warning detection level(3673h) Over-load warning release level (3674h)	Supported Over-load warning detection level(3695h) Over-load warning release level (3696h)	
		D3h (Over-travel inhibition warning)	Not supported	Supported	
7-4	Excess positional deviation protection setting	<ul style="list-style-type: none"> • Position deviation excess setup 3014h(Position deviation excess setup) • Positioning complete range unit 3431h(Positioning complete (In-position) range) 3442h(Positioning complete (In-position) range 2) 	Encoder unit	It is possible to change to command unit or encoder unit(external scale unit) by 3520h(Position setup unit select). 3520h = 0 : command unit 3520h = 1 : encoder unit (external scale)	It is possible to change to command unit or feedback unit by 3520h(Position setup unit select). 3520h = 0 : command unit 3520h = 1 : feedback scale unit
8-1	safe torque off (STO) function	The state when STO function is activated.	Alarm state Occurrence of Err30.0 (safety input protection)	Alarm does not occur. Front panel display is "St".	

<SX-DSV03307 : Technical document (EtherCAT Communication Specifications)>

Please refer to technical document EtherCAT communication specification (SX-DSV03307), Section 1-2 for details.

2. Interface Specification

2-1 I/O connector input signal

Title of signal	Symbol	Connector pin No. *2)	Contents	Related control mode *1)			EtherCAT communications	
				Position	Velocity	Torque	command	monitor *3)
Input signal source	I-COM	6	<ul style="list-style-type: none"> Connect to the positive or negative terminal of the external DC source (12–24 V). 	/	/	/	/	/
Forced alarm input	E-STOP	*	<ul style="list-style-type: none"> Generates Err 87.0 “Forced alarm input error”. It can be monitored with 4F21h (Logical input signal). 	○	○	○	-	○
Positive direction over-travel inhibition input	POT	7 (SI2)	<ul style="list-style-type: none"> Positive direction over-travel inhibit input. The operation with this input turned ON is set up in Pr 5.04 “Setup of over-travel inhibit input”. When using Positive direction over-travel inhibit input, connect the signal so that the input is turned ON when the moving portion of the machine travels in positive direction exceeding a limit. If used as a home position reference trigger in a home position return, this input signal can only be assigned to SI6, respectively. The signal width should be 1 ms or longer then at the time of closing, and should be 2 ms or longer then at the time of opening. Please keep in mind that it cannot guarantee this value. 	○	○	○	-	○
Negative direction over-travel inhibition input	NOT	8 (SI3)	<ul style="list-style-type: none"> Negative direction over-travel inhibit input. The operation with this input turned ON is set up in Pr 5.04 “Setup of over-travel inhibit input”. When using Negative direction over-travel inhibit input, connect the signal so that the input is turned ON when the moving portion of the machine travels in negative direction exceeding a limit. If used as a home position reference trigger in a home position return, this input signal can only be assigned to SI7, respectively. The signal width should be 1 ms or longer then at the time of closing, and should be 2 ms or longer then at the time of opening. Please keep in mind that it cannot guarantee this value. 	○	○	○	-	○
Near home input	HOME	9 (SI4)	<ul style="list-style-type: none"> When using the near home sensor during the return to home position operation, input the sensor signal. If used as a home position reference trigger in a home position return, the input can only be assigned to SI5, respectively. The signal width should be 1 ms or longer then at the time of closing, and should be 2 ms or longer then at the time of opening. Please keep in mind that it cannot guarantee this value. 	○	○	○	-	○
Retracting operation input	RET	*	<ul style="list-style-type: none"> Activates a retracting operation if conditions are satisfied according to the setting for Pr6.85 “Retracting operation condition setting” 	○	○	○	-	○

(To be continued)

Title of signal	Symbol	Connector pin No. *2)	Contents	Related control mode *1)			EtherCAT communications	
				Position	Velocity	Torque	command	monitor *3)
External latch input 1	EXT1	10 (SI5)	<ul style="list-style-type: none"> • These signals are used for touch-probe function or homing function. • This input can only be set to a-contact. • The signal width should be 1 ms or longer then at the time of closing, and should be 2 ms or longer then at the time of opening. It cannot guarantee this value. • EXT1 can only be assigned to S15. • EXT2 can only be assigned to S16. 	○	○	○	-	○
External latch input 2	EXT2	11 (SI6)		○	○	○	-	○
General purpose monitor input 1	SI-MON1	*	<ul style="list-style-type: none"> • Used as the general purpose monitor input. • This input does not affect the operation, and can be used for monitoring through 4F21h(Logical input signal), 4F23h(Logical input signal(expansion portion)), 60FDh(Digital inputs). 	△	△	△	-	○
General purpose monitor input 2	SI-MON2	*		△	△	△	-	○
General purpose monitor input 3	SI-MON3	12 (SI7)		△	△	△	-	○
General purpose monitor input 4	SI-MON4	13 (SI8)		△	△	△	-	○
General purpose monitor input 5	SI-MON5	5 (SI1)		△	△	△	-	○
External alarm clear input	A-CLR	*	<ul style="list-style-type: none"> • Dis arm inputs the alarm. • There are alarms that cannot be disarmed by this input. 	○	○	○	-	○
Dynamic brake (DB) switching input	DB-SEL	*	<ul style="list-style-type: none"> • Switches the dynamic brake (DB) ON/OFF after stop (when the main power is off). • Switching is only possible when main power supply off is detected. • For details, refer to 6-3-3. 	○	○	○	-	○

*1) The triangle in the table under [Control mode] indicates that the turning ON/OFF of the input signal does not affect system operation.

2) Except for I-COM, input signal pin assignment can be changed. The pins in “Connector pin No.” column in the table denote factory default settings. The signal with a pin that is marked with “” is not assigned by default. For more information, refer to “2-4-1 Input signal allocation”.

*3) It is possible to monitor the condition of the signals where “○” is attached to the EtherCAT communication monitor on the table with 4F21h(Logical input signal), 4F23h(Logical input signal(expansion portion)), 60FDh (Digital inputs).

2-2 I/O connector output signal									
Title of signal	Symbol *2)	Connector pin No.	Contents	Related control mode *1)			EtherCAT communi- cations		
				Position	Velocity	Torque	command	monitor *3)	
Servo-Alarm output	ALM+	3 (S03+)	<ul style="list-style-type: none"> This signal shows that the driver is in alarm status. Output transistor turns ON when the driver is at normal status, and turns OFF at alarm status. 	○	○	○	—	○	
	ALM- (Alarm)	4 (S03-)							
Servo-Ready output	S-RDY (Servo_Ready)	*	<ul style="list-style-type: none"> This signal shows that the driver is ready to be activated. The servo becomes ready when all the following conditions are satisfied, and the output transistor is turned on. <ol style="list-style-type: none"> Control/Main power is established. Alarm does not occur. EtherCAT communication is established. 	○	○	○	—	○	
External brake release signal	BRK-OFF+	1 (S01+)	<ul style="list-style-type: none"> Feeds out the timing signal which activates the electromagnetic brake of the motor. Transistor is turned ON when electromagnetic brake is released. This output needs to be assigned to every control mode. 	○	○	○	—	○	
	BRK-OFF-	1 (S01-)							
set brake output	set brake	*	<ul style="list-style-type: none"> Outputs the signal configured at 60FEh:Digital output /bit 0. Transistor will be turned off at “1”. (Brake will be activated.) See the notes *4) state the output transistor. 	○	○	○	○	—	
Positioning complete	INP	*	<ul style="list-style-type: none"> Outputs the positioning complete signal/positioning complete signal. Turns ON the output transistor when positioning is completed. For details, refer to 4-2-4. 	○	—	—	—	○	
Speed arrival output	AT-SPEED	*	<ul style="list-style-type: none"> Outputs the speed arrival signal. Turns on the output transistor when a velocity is reached. For details, refer to 4-3-1. 	—	○	○	—	○	
Torque in-limit signal output	TLC	*	<ul style="list-style-type: none"> Outputs the torque in-limit signal. Turns on the output transistor when torque is limited. For details, refer to 6-4. 	○	○	○	—	○	
Zero-speed detection output signal	ZSP	*	<ul style="list-style-type: none"> Outputs the zero-speed detection signal. Turns on the output transistor when zero velocity is detected. 	○	○	○	—	○	
Speed matching output	V-COIN	*	<ul style="list-style-type: none"> Outputs the speed matching signal. Turns on the output transistor when velocity matches. For details, refer to 4-3-2. 	—	○	○	—	○	
Positioning complete 2	INP2	*	<ul style="list-style-type: none"> Outputs the positioning complete signal/positioning complete signal 2. Turns on the output transistor upon positioning completion 2. For details, refer to 4-2-4. 	○	—	—	—	○	
Warning output 1	WARN1	*	<ul style="list-style-type: none"> Outputs the warning output signal set to Pr 4.40 “Warning output select 1” Turns on the output transistor when a selected alarm occurs. 	○	○	○	—	○	
Warning output 2	WARN2	*	<ul style="list-style-type: none"> Outputs the warning output signal set to Pr 4.41 “Warning output select 2” Turns on the output transistor when a selected alarm occurs. 	○	○	○	—	○	

Title of signal	Symbol *2)	Connector pin No.	Contents	Related control mode *1)			EtherCAT communi- cations	
				Position	Velocity	Torque	command	monitor *3)
Positional command ON/OFF output	P-CMD	*	<ul style="list-style-type: none"> Outputs the position command ON/OFF signal. Turns on the output transistor when the positioning command (before filter) is other than 0 (with positioning command). 	○	—	—	—	○
Speed in-limit output	V-LIMIT	*	<ul style="list-style-type: none"> Outputs the speed limit signal during torque command. Turns on the output transistor when velocity is limited. 	—	—	○	—	○
Alarm attribute output	ALM-ATB	*	<ul style="list-style-type: none"> The signal is output if an alarm which can be cleared, is input. Turns on the output transistor when an alarm occurs. 	○	○	○	—	○
Velocity command ON/OFF output	V-CMD	*	<ul style="list-style-type: none"> Turns on output transistor when the velocity command is applied while the velocity is controlled. Turns on the output transistor if the velocity command (before filter) is not less than 30r/min (with velocity command). 	—	○	—	—	○
General purpose output 1	EX-OUT1+	25 (S02+)	<ul style="list-style-type: none"> Output signal set by Bit16 of 60FEh(Digital outputs). (ON at 1, OFF at 0) For the state of the output transistor, refer to Note *4. 	○	○	○	○	○
	EX-OUT1-	26 (S02-)						
Servo on status output	SRV-ST (Servo_Active)	*	<ul style="list-style-type: none"> Turns on the output transistor during servo on. 	○	○	○	—	○
Position comparison output	CMP-OUT	*	<ul style="list-style-type: none"> The output transistor is turned ON or OFF when the actual position passes the position set by the parameter. 	○	○	○	—	—
Deterioration diagnosis velocity output	V-DIAG	*	<ul style="list-style-type: none"> Output transistor turned ON when motor speed is within the range of Pr4.35 “Speed coincidence range” of Pr5.75 “Deterioration diagnosis velocity setting”. There is a hysteresis of 10r/min in the coincidence judgment of deterioration diagnosis velocity. 	○	○	○	—	○
Estimated pole position output	CS-CMP	*	<ul style="list-style-type: none"> When the pole position was estimated, the output transistor is turned ON. In the case of linear (VCM) types, the output transistor is turned ON after power-on. For information on the output transistor, refer to Note *6. 	○	○	○	—	○

*1) For the signal with “-” sign in the “Related control mode” column, the output transistor is always turned off in that control mode.

2) Output pin assignment can be changed. The pins in “Connector pin No.” column in the table denote factory default settings. The signal with a pin that is marked with “” is not assigned by default. For more information, refer to “2-4-2 Assignment of output signal”.

*3) It is possible to monitor the condition of the signals where “○” is attached to the EtherCAT communication monitor on the table with 4F22h(Logical output signal) or 60FDh (Digital inputs).

*4) The state of output transistor changes as follows in each communication state:

Sign	Setting value of Pr7.24	Setting value of 60FEh		State of output transistor			
		01h (Physical outputs)	02h (Bit mask)	Reset	Communication established *5)	Communication intercepted *5)	Communication re-established *5)
set brake	-	0	0	set brake = 1 (brake on)	set brake = 1 (brake on)	set brake = 1 (brake on)	set brake = 1 (brake on)
		1					
		0	1	set brake = 1 (brake on)	set brake = 0	set brake = 1 (brake on)	set brake = 0
		1			set brake = 1 (brake on)		set brake = 1 (brake on)
EX-OUT1	bit0 = 0 (hold)	0	0	EX-OUT1 = 0	EX-OUT1 = 0	EX-OUT1 = 0	EX-OUT1 = 0
		1					
		0	1	EX-OUT1 = 0	EX-OUT1 = 0	EX-OUT1 = 0 (hold)	EX-OUT1 = 0
		1			EX-OUT1 = 1	EX-OUT1 = 1 (hold)	EX-OUT1 = 1
	bit0 = 1 (initialization)	0	0	EX-OUT1 = 0	EX-OUT1 = 0	EX-OUT1 = 0	EX-OUT1 = 0
		1					
		0	1	EX-OUT1 = 0	EX-OUT1 = 0	EX-OUT1 = 0	EX-OUT1 = 0
		1			EX-OUT1 = 1		EX-OUT1 = 1

*5) “Communication established”, “Communication intercepted”, and “Communication re-established” refer to the following cases.

Communication established	ESM state is PreOP or higher
Communication intercepted	PDO communication is disabled (ESM state transitioned to other states than OP), or SDO communication is disabled (ESM state transitioned to Init)
Communication re-established	60FEh-01h or 60FEh-02h has been written successfully

Safety precautions:

When executing set brake signal control using 60FEh (Digital outputs), be sure to use it in PDO and enable the PDO watch dog.
In SDO, the communication shutoff cannot be judged, the brake may be kept to be released and it is unsafe.
Please ensure safety on the equipment side.

*6) The timing when the Estimated pole position output (CS-CMP) is turned ON may vary according to the conditions below.

Pr9.20 (Pole detection method)	Timing when Estimated pole position output turns ON
0 (undefined)	Does not turn ON.
1 (CS signal)	After the initialization is completed during the control power-on
2 (Pole position estimation)	After the pole position is estimated successfully (does not turn ON on abort)
3 Pole position recovery)	After the pole position is recovered successfully (does not turn ON on abort)

2-3 I/O connector other signal
 2-3-1 Encoder output signal / Position comparison output signal

Title of signal	Symbol	Connector pin No.	Contents	Control mode			EtherCAT communications	
				Position	Velocity	Torque	command	monitor
Frame ground To be used by the manufacturer.	OA+ / OCMP1+	17	<ul style="list-style-type: none"> Outputs frequency-divided feedback scale signals (A/B phase) differentially (RS422 equivalent). Ground for line driver of output circuit is connected to signal ground (GND) and is not insulated. Max. output frequency is 4 Mpps (after quadrupled) When Pr4.47 "Pulse output selection" is set to 1, can be used as position compare output. 	○				
	OA- / OCMP1-	18						
B-phase output / Position comparison output 2	OB+ / OCMP2+	20						
	OB- / OCMP2-	19						
Position comparison output 3	OCMP3+	21						
	OCMP3-	22						
Signal ground	GND	16	• Signal ground					

2-3-2 Others

Title of signal	Symbol	Connector pin No.	Contents	Control mode			EtherCAT communications	
				Position	Velocity	Torque	command	monitor
Frame ground	FG	shell	• This output is connected to the ground terminal inside of the driver.					
To be used by the manufacturer.	—	23, 24	• Keep these pins unconnected.					

2-4 signal allocation function

Default I/O signal allocation can be changed.

2-4-1 Input signal allocation

Desired input signal can be allocated to any input pin of I/O connector. The logic can be changed.

Some allocation limit is applied to specific signals. Refer to “(2) Reallocation of input signal”.

(1) Using with the default setting

The table below shows default signal allocation.

Note: Default settings of certain model will differ from those shown below. If the default settings shown in Standard specification are different from values shown below, the settings described in Standard specification are valid default values.

Pin name	Pin No.	Applicable parameter	Default setting (): decimal notation	Default setup					
				Position control		Velocity control		Torque control	
				Signal	Logic *1)	Signal	Logic *1)	Signal	Logic *1)
SI1	5	Pr 4.00	00323232h (3289650)	SI-MON5	a-contact	SI-MON5	a-contact	SI-MON5	a-contact
SI2	7	Pr 4.01	00818181h (8487297)	POT	b-contact	POT	b-contact	POT	b-contact
SI3	8	Pr 4.02	00828282h (8553090)	NOT	b-contact	NOT	b-contact	NOT	b-contact
SI4	9	Pr 4.03	00222222h (2236962)	HOME	a-contact	HOME	a-contact	HOME	a-contact
SI5	10	Pr 4.04	00202020h (2105376)	EXT1	a-contact	EXT1	a-contact	EXT1	a-contact
SI6	11	Pr 4.05	00212121h (2171169)	EXT2	a-contact	EXT2	a-contact	EXT2	a-contact
SI7	12	Pr 4.06	00303030h (3158064)	SI-MON3	a-contact	SI-MON3	a-contact	SI-MON3	a-contact
SI8	13	Pr 4.07	00313131h (3223857)	SI-MON4	a-contact	SI-MON4	a-contact	SI-MON4	a-contact

*1) Operation of a-contact and b-contact:

a-contact: The current in the input circuit is shut down and the photocoupler is turned OFF.

— function disabled (OFF state)

The current flows through the input circuit and the photocoupler is turned ON.

— function enabled (ON state)

b-contact: The current in the input circuit is shut down and the photocoupler is turned OFF.

— function enabled (ON state)

The current flows through the input circuit and the photocoupler is turned ON.

— function disabled (OFF state)

For the purpose of this specification, the status of the input signal is defined as ON when the signal activates the specified function and OFF when the signal deactivates the specified function.

And when the photocoupler is turned OFF, time to signal detection becomes long and Variation becomes large.

(2) Reallocation of input signal

To change the allocation of input signal, change the following parameters.

Class	No.	Attribute *1)	Title	Range	Unit	Function	Latch correction function
4	00	C	SI1 input selection	0-00FFFFFFh	—	<p>Assign functions to SI1 inputs. These parameters are presented in hexadecimals. Hexadecimal presentation is followed by a specific control mode designation. 00----**h: position control 00--**--h: velocity control 00**----h: torque control Replace ** with the function number. For the function number see the table below. Logical setup is also a function number.</p> <p>Example: To make this pin as SI-MON1_a-contact for position control, and as SI-MON2_b-contact for velocity control, and as disabled in torque control mode, set to 0000AF2Eh. Position ... 2Eh Velocity ... AFh Torque ... 00h</p>	—
4	01	C	SI2 input selection	0-00FFFFFFh	—	<p>Assign functions to SI2 inputs. Setup procedure is the same as described for Pr 4.00.</p>	—
4	02	C	SI3 input selection	0-00FFFFFFh	—	<p>Assign functions to SI3 inputs. Setup procedure is the same as described for Pr 4.00.</p>	—
4	03	C	SI4 input selection	0-00FFFFFFh	—	<p>Assign functions to SI4 inputs. Setup procedure is the same as described for Pr 4.00.</p>	—
4	04	C	SI5 input selection	0-00FFFFFFh	—	<p>Assign functions to SI5 inputs. Setup procedure is the same as described for Pr 4.00. * This pin has a latch correction function.</p>	○
4	05	C	SI6 input selection	0-00FFFFFFh	—	<p>Assign functions to SI6 inputs. Setup procedure is the same as described for Pr 4.00. * This pin has a latch correction function.</p>	○
4	06	C	SI7 input selection	0-00FFFFFFh	—	<p>Assign functions to SI7 inputs. Setup procedure is the same as described for Pr 4.00. * This pin has a latch correction function.</p>	○
4	07	C	SI8 input selection	0-00FFFFFFh	—	<p>Assign functions to SI8 inputs. Setup procedure is the same as described for Pr 4.00.</p>	—

*1) For parameter attribute. refer to Section 9-1.

Function number table

Title	Symbol	Setup value	
		a-contact	b-contact
Invalid	—	00h	Can not configure
Positive direction over-travel inhibition input	POT	01h	81h
Negative direction over-travel inhibition input	NOT	02h	82h
External alarm clear input	A-CLR	04h	Can not configure
Forced alarm input	E-STOP	14h	94h
Dynamic brake switching input	DB-SEL	16h	Can not configure
External latch input 1	EXT1	20h	A0h
External latch input 2	EXT2	21h	A1h
Near home input	HOME	22h	A2h
Retracting operation input	RET	27h	A7h
General purpose monitor input 1	SI-MON1	2Eh	AEh
General purpose monitor input 2	SI-MON2	2Fh	AFh
General purpose monitor input 3	SI-MON3	30h	B0h
General purpose monitor input 4	SI-MON4	31h	B1h
General purpose monitor input 5	SI-MON5	32h	B2h

■ Precautions for input signal assignment

- Do not setup to a value other than that specified in the table.
- The same signal can't be assigned to multiple pins. Otherwise, duplicated assignment will cause Err 33.0 "Input multiple assignment error 1 protection" or Err 33.1 "Input multiple assignment error 2 protection".
- A signal used in multiple control modes should be assigned to the same pin and the logic should be matched. If not assigned to the same pin, the Err33.0 "Input duplicate assignment error 1 protection" or Err33.1 "Input duplicate assignment error 2 protection" occurs. In case that the logics do not match, Err33.2 "Input function number error 1 protection" or Err33.3 "Input function number error 2 protection" will occur.
- The duplicated assignment of SI-MON1 and EXT1, SI-MON2 and EXT2, and SI-MON5 and E-STOP is not allowed. Duplicate assignment will cause Err33.0 "Input duplicate assignment error 1 protection" or Err33.1 "Input duplicate assignment error 2 protection".
- A-CLR can only be set at a-connect. If set at b-connect, then Err33.2 "Input function number assignment error 1 protection" or Err33.3 "Input function number assignment error 2 protection" will occur.
- The control mode is switched forcibly inside the driver depending on its operating status irrespective of the command from the host device. This operation has an effect on input signal processing.

Basically, please allocate same function in one terminal in all modes.

[Conditions that the control mode is switched forcibly inside the driver]

- When frequency characteristic is measured by Setup support software.
(Position loop characteristics is position control, the speed closed loop characteristic and torque speed (vertical) are speed control, torque speed (normal) is torque control.)
 - Test run of the setup support software (Forcibly controls the position).
 - During pole position estimation.
 - The states that are written "Forcibly controls the position" in "Deceleration stop sequence" (Section 6-3).
 - "Retracting operation" in operation (Forcibly controls the position)
- Setting is required for all control modes after setting Pr6.36 "Dynamic brake operation input setup" to 1, in case of using dynamic brake switching input (DB-SEL). In case only one or two control modes are set, either Err33.2 "Input function number error 1" or Err33.3 "Input function number error 2" will occur. Please refer to 6-3-3 for details.

<Precautions for latch correction pins (SI5/SI6/SI7)>

- EXT1 can be allocated only to SI5, EXT2 only to SI6. Wrong allocation will cause Err 33.8 “Latch input allocation error protection”.
- In the following cases, Err33.8 “Latch input allocation error protection” occurs
 - HOME is assigned to SI6 or SI7
 - POT is assigned to SI5 or SI7
 - NOT is assigned to SI5 or SI6
- When using POT/NOT as the home reference trigger in the return to home position operation, set Pr 5.04 to 1 . If Pr 5.04 is not 1, Err38.2 “Over-travel inhibit input protection 3” occurs.
- When latch correction pins (SI5/SI6/SI7) are used, set up is required for all the control modes. If configuration is made only for 1 or 2 modes, the Err33.8 “Latch input allocation error protection” occurs.

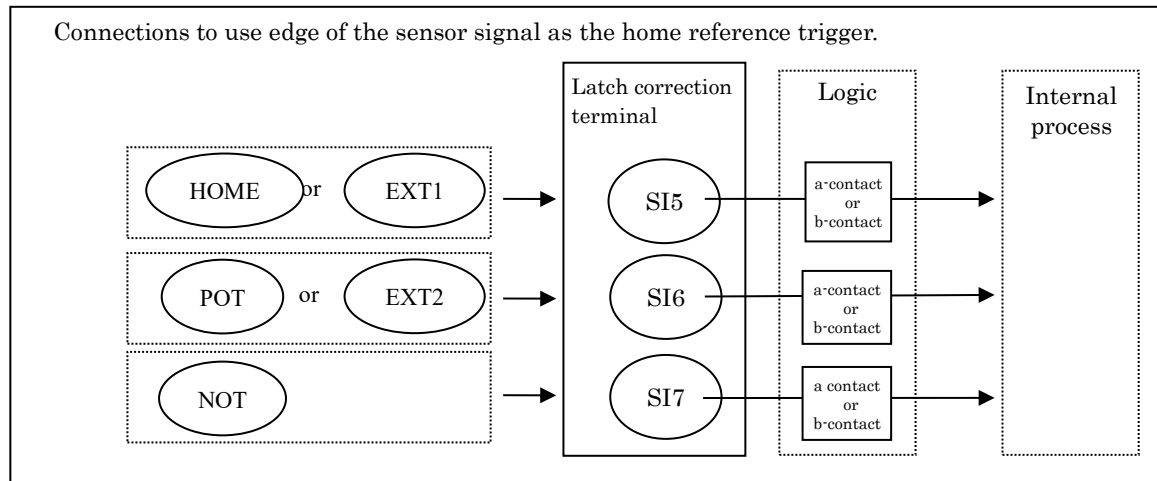
**Safety precautions:**

The over-travel inhibit input (POT, NOT) and forced alarm input (E-STOP) should normally be set to b-contact, which stops when wire is broken.
If a-contact is specified, be sure that there is no safety hazard.

2-4-2 Assignment of output signal

For the output signals, any functions can be assigned to the output pins of the I/O connector. Some assignments may be restricted. Refer to (2) [Reallocation of output signal].

(1) Using the default setting

The table below shows default signal allocation.

Note: Default settings of certain model will differ from those shown below. If the default settings shown in Standard specification are different from values shown below, the settings described in Standard specification become valid standard default values.

Pin name	Pin No.	Applicable parameter	Default setting (): decimal notation	Default Setup		
				Position control	Velocity control	Torque control
SO1	1 2	Pr 4.10	00030303h (197379)	BRK-OFF	BRK-OFF	BRK-OFF
SO2	25 26	Pr 4.11	00101010h (1052688)	EX-OUT1	EX-OUT1	EX-OUT1
SO3	3 4	Pr 4.12	00010101h (65793)	ALM	ALM	ALM

- For V frame, SO3 is fixed to ALM. Please do not change Pr4.12 from the shipment value setting.

(2) [Reallocation of output signal].

To change the allocation of output signal, change the following parameters.

Class	No.	Attribute *1)	Title	Range	Unit	Function
4	10	C	SO1 output selection	0– 00FFFFFFh	—	Assign functions to SO1 outputs. These parameters are presented in hexadecimal. Hexadecimal presentation is followed by a specific control mode designation. 0 0 – – – * * h: position control 0 0 – * * – – h: velocity control 0 0 * * – – – h: torque control Replace * * with the function number. For the function number see the table below.
4	11	C	SO2 output selection	0– 00FFFFFFh	—	Assign functions to SO2 outputs. Setup procedure is the same as described for Pr 4.10.
4	12	C	SO3 output selection	0– 00FFFFFFh	—	Assign functions to SO3 outputs. Setup procedure is the same as described for Pr 4.10. ※Please do not change the shipment value setting with V frame.

*1) For parameter attribute, refer to Section 9-1.

Function number table

Title of signal	Symbol	Setup value
	External output	
Invalid	—	00h
Alarm output	ALM	01h
Servo-Ready output	S-RDY	02h
External brake release signal	BRK-OFF	03h
Positioning complete output	INP	04h
At-velocity output	AT-SPEED	05h
Torque in-limit signal output	TLC	06h
Zero-speed detection output signal	ZSP	07h
Speed matching output	V-COIN	08h
Warning output1	WARN1	09h
Warning output2	WARN2	0Ah
Positional command ON/OFF output	P-CMD	0Bh
Positioning complete 2	INP2	0Ch
Speed in-limit output	V-LIMIT	0Dh
Alarm attribute output	ALM-ATB	0Eh
Velocity command ON/OFF output	V-CMD	0Fh
General purpose output 1	EX-OUT1	10h
set brake output *1)	set brake	11h
Servo on status output	SRV-ST	12h
Position comparison output	CMP-OUT	14h
Deterioration diagnosis velocity output	V-DIAG	15h
Estimated pole position output	CS-CMP	16h

*1) “set brake output” is reversal from logic of 60FEh(digital output).
When 60FEh is “1”, the output signal is “OFF” (brake is activate).

■ Precautions for output signal assignment

- For output signals, the same function can be assigned to multiple pins. However, the output logic setting must be the same. In addition, when using the same function for multiple control modes, the same output logic must be set. If different output logic was set, the output signal state will become unstable.
- For the output pins specified as disabled, output transistors are always turned off. However, EtherCAT communication response is not affected.
- Use only the values shown in the table above for setting.
- When using external brake release signal (BRK-OFF) or set brake output, the signal should be set in all control modes. If not applied to all control modes, Err 33.4 "Output function number error 1 protection" or Err 33.5 "Output function number error 2 protection" will occur.
- The output transistor is turned off, during a period from when the driver's control power of a servo amplifier is turned on to when initialization is completed. And while control power is turned off, during a reset, and while the display on the front face indicates as follows:



Design of system needs to consider the above fact so that any problem does not occur.

- The control mode is switched forcibly inside the driver depending on its operating status irrespective of the command from the host device. This operation has an effect on input signal processing. Basically, please allocate same function in one terminal in all modes.
[Conditions for the control mode to be switched forcibly inside the driver]
 - When frequency characteristic is measured by Setup support software.
(Position loop characteristics is position control, the speed closed loop characteristic and torque speed (vertical) are speed control, torque speed (normal) is torque control.)
 - Test run of the setup support software (Forcibly controls the position).
 - During pole position estimation.
 - The states that are written "Forcibly controls the position" in "Deceleration stop sequence" (Section 6-3).
 - "Retracting operation" in operation (Forcibly controls the position)
- Since the most significant bit (80h) of the function number is used as a reserved bit, it is not subject to the judgment of Err33.4 "Output function number error 1 protection" and Err33.5 "Output function number error 2 protection". Therefore, setting the most significant bit to 1 does not cause an error.
A signal corresponding a value excluding the most significant bit from the set value is assigned. For example, if a set value is 81h, the signal is assigned as 01h (alarm output).

3. Front panel display specification

3-1 Appearance of front panel

Other than V frame

EtherCAT Indicators
 RUN: Green L/A IN: Green
 ERR: Red L/A OUT: Green

7-segment LED (2-digit)

Analog monitor pins (X7)

Pin No.	Symbol	Contents
1	AM1	Analog monitor 1
2	AM2	Analog monitor 2
3	GND	Signal ground
4, 5	-	Reserved (Do not use)

NOTE: Pin No.1 from the left, 2, 3 ... Order

Rotary switch for station alias (ID) setup

V frame

L/A IN L/A OUT
 ERR RUN

ALM SRVON

L/A OUT LED
 L/A IN LED
 RUN LED
 ERR LED

SRVON LED
 ALM LED

3-2 7 Segment LED, ALM and SRVON LED

3-2-1 7 Segment LED

Cannot be used with [V frame].

Station alias value set with RSW will be displayed at control power-UP, after that, the setting contents of Pr 7.00 (LED display) will be displayed.

Upon occurrence of an alarm, set of alarm codes (main and sub, alternately) is displayed. Upon occurrence of warning, the warning code will be displayed.

■ Relevant parameters

Class	No.	At-tribute *1)	Title	Range	Unit	Function
7	00	A	Information on LED	0-32767	—	Selects the information displayed on 7-SEG LED display.
7	01	R	Address display time upon power up	0-1000	100 ms	Sets Station alias(Lower) display (NOTE) time upon turning the control power ON. When the setting value is 0 to 6, it is processed in 600ms. (NOTE) In the case of Pr7.41(Station alias selection)=1, although SII's setting value is used to Station alias, even in this case, display the setting value of the rotary switch.

*1) For parameter attribute, refer to Section 9-1.

Pr 7.00	Information on display	Remarks
0	Normal display	[--]: servo OFF, [00]: servo ON
2	Electrical angle	Display range: 0 to FF hex. 0: the position where U phase induced voltage reaches the positive peak. Data increments as motor turns CCW. When the displayed value exceeds [FF], the count is reset to [0] and restarted.
4	Station alias value (Rotary switch setting)	Lower 8bits of station alias value that set by rotary switch at power ON is displayed. Station alias is 0 to F[hex], the display is one-digit. Station alias is upper than 10[hex], the display is two-digit. Values to be read out vary depending on the setting values of Pr7.41 "Station alias selection". Pr7.41=0: Rotary switch of the front panel and the setting value of Pr7.40 However, if both are 0, then the Value of SII area (0004h). Pr7.41=1: Value of SII area (0004h)
6	Feedback scale accumulated communication error counts	Display range: 0 to FF hex. Max. accumulated communication error counts: FFFF hex. Only the least significant byte is displayed. When the displayed value exceeds [FF], the count is reset to [00] and continue counting. *Accumulated communication error counts will be cleared upon turning the control power OFF.
7	Z phase counter	When the feedback scale is used in full closed control or in semi-closed control with the scale position information monitor function enabled, displays the value of Z phase counter read from feedback scale: 0-F hex. * This displayed value is not affected by the value of Pr 3.26 Reversal of direction of feedback scale. This function is effective only in the case of the feedback scale and in the external scale of the A/B/Z phase, "nA" (not Available) is indicated.
8	Pole position estimated accuracy	The estimated accuracy is shown as 0 to B4 [hex] (electric angle: 0 to 180 [degree]) when estimating a pole position. Example: When the display is ' A': It means that the pole position estimated accuracy is up to ±10 [degree] in electric angle. <ul style="list-style-type: none"> ▪ The smaller this numeric value is, the better the accuracy is. ▪ This accuracy is an estimated accuracy based on the pole position estimation method and will not guarantee a real accuracy. Use it only for reference. ▪ When the pole position is not yet estimated, 'b4' is shown. ▪ When estimating the pole position, 'b4' is shown. ▪ When an error occurs in estimating the pole position, 'b4' is shown. ▪ If Pr9.20 "Pole detection method" ≠ 2 (other than pole position estimation), ' 0' is shown.

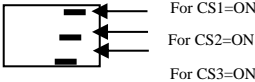
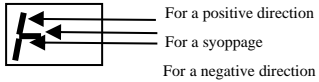
Pr 7.00	Information on display	Remarks
9	CS signal, operation direction	<p>If Pr9.20 “Pole detection method” = 1 (CS signal), the CS signal status is shown at the right and the operation direction is shown at the left.</p> <ul style="list-style-type: none"> CS signal status CS1, 2, 3 are shown from the top downward, ‘-’ is shown for ON, and nothing is shown for OFF. Note that the CS signal is shown with Pr3.26 (signal (original signal) before the inversion process).  <p>Operation direction The upper left LED lights up when running (speed is 30 mm/s or more) in a positive direction. The lower left LED lights up when running (speed is -30 mm/s or less) in a negative direction. The center LED lights up when it stops (otherwise).</p>  <p>When other than Pr9.20 = 1, ‘nA’ is shown.</p>
10	Overload rate	<p>Displayed by 0 to FF [hex]. Indicates the ratio [%] against rated load. When the overload rate is 100%, “64” is displayed. Will indicate “nA” (not Available) in case the load ratio is larger than FF [hex].</p>
Other	To be used by the manufacturer but not by the user.	—

The following figure shows the state flow of 7-segment LED.

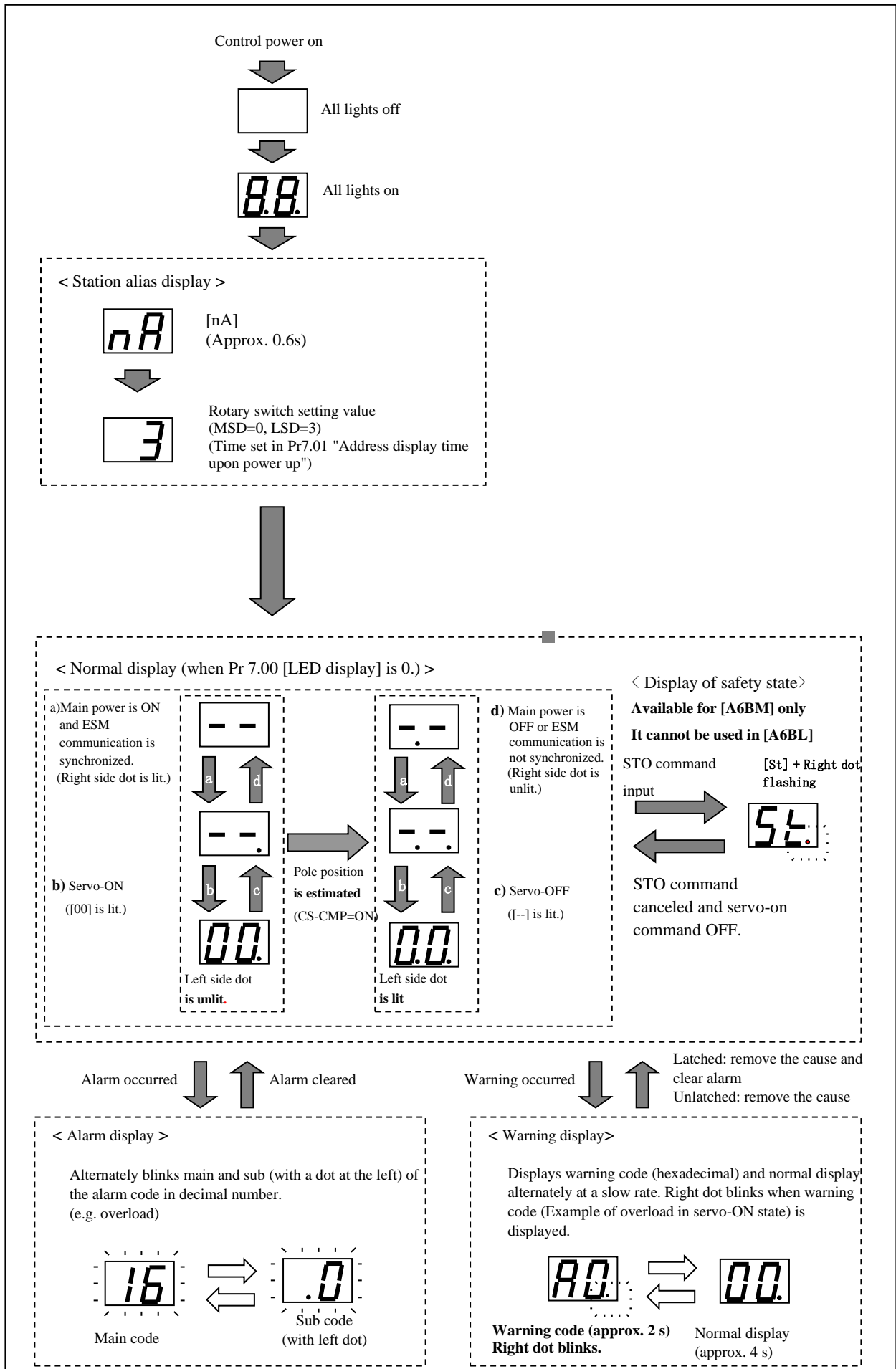

3-2-2 ALM LED and SRVON LED

V frame, ALM LED and SRVON LED are equipped for simple status check.

Display	Description	Display color	Status	Description
ALM	Alarm LED	Red	Lit	Alarm occurred
			Not lit	Normal
SRVON	Servo on LED	Green	Lit	Motor servo ON status
			Not lit	Motor servo OFF status

3-3 EtherCAT Indicators

MINAS-A6BL series has 4 types of EtherCAT indicators (LED).

There are 4 patterns of LED indication in addition to "ON" and "OFF"

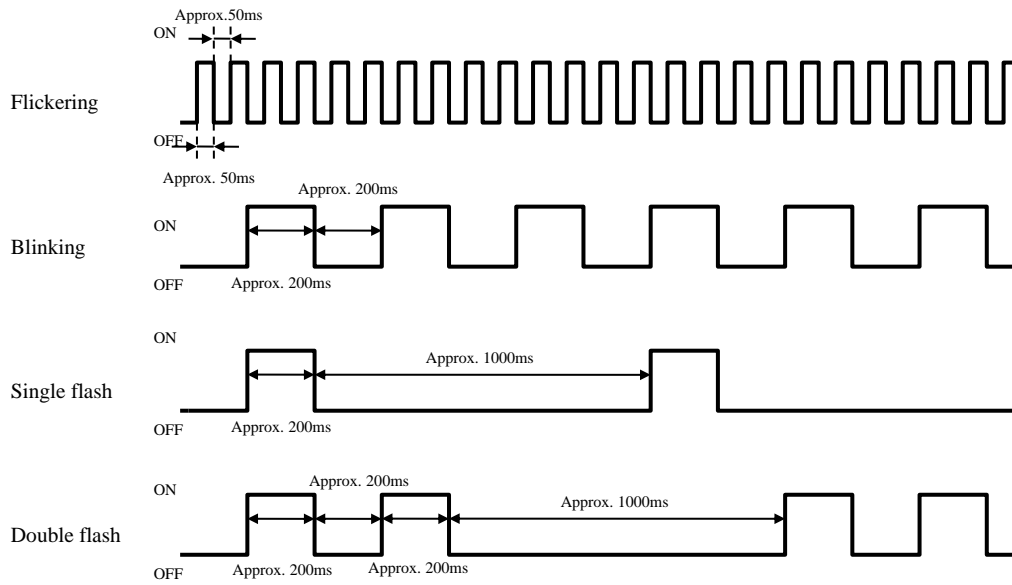

Other than V frame

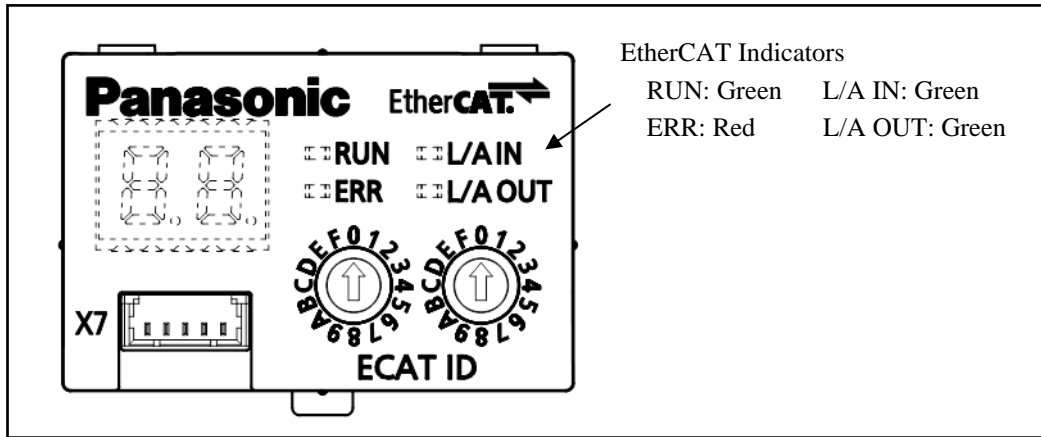

V frame

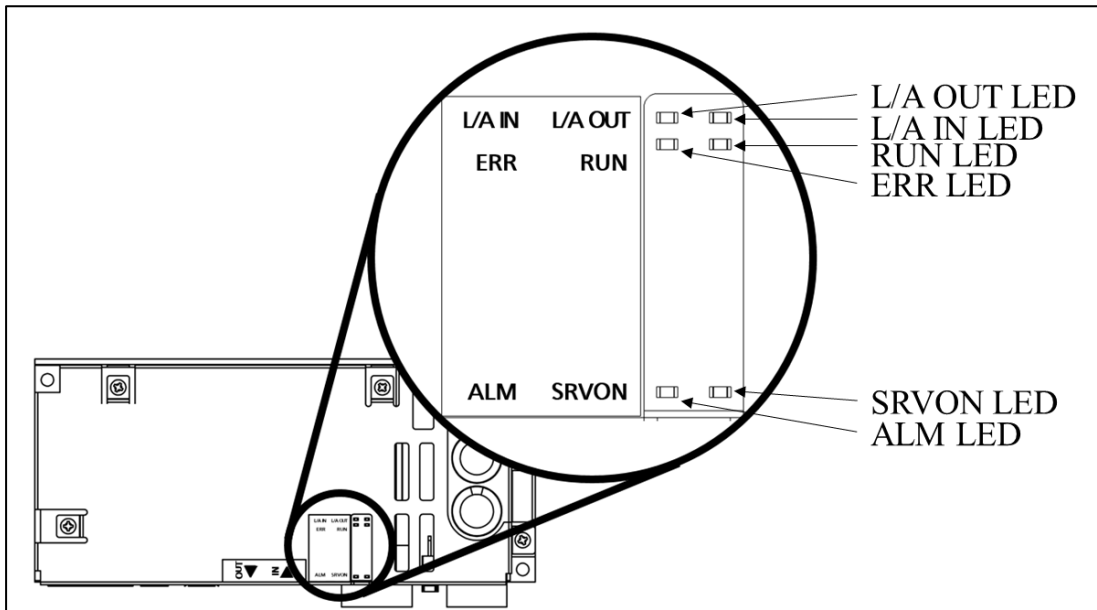

1) RUN

RUN indicator will show the status of ESM(EtherCAT State Machine).
Indication is lighted in green.

LED	Content
OFF	ESM:INIT
Flickering	ESM:Bootstrap
Blinking	ESM:Pre-Operational
Single flash	ESM:Safe-Operational
ON	ESM:Operational

2) ERR

ERR Indicator will show the state of the alarm defined by AL status code. *1)
Indication is lighted in red.

LED	Content
OFF	With no generating of the alarm defined by AL Status code *1)
Blinking	Communication setting error
Single flash	Synchronize event error
Double flash	Application watch dog time out
Flickering	Initialize error
ON	PDI error *2)

*1) " The alarm defined by AL status code " is which indicate Err80.0-7 and Err81.0-7, Err85.0-7 in the EtherCAT communication related error.

*2) MINAS-A6BL series is not detected.

3) L/A IN

4) L/A OUT

L/A IN, L/A OUT indicator will show the LINK status and operation status of
Each port's physical layer.
Indication is lighted in green.

LED	Content
OFF	LINK not established
Flickering	LINK established. There are data transmission and reception.
ON	LINK established. There are no data transmission and reception.

If the period until LINK establishment is too long, this phenomenon may be improved by the following measures.

- Changing bit11 (Link establishment mode selection) in Pr7.22 "Communication function extended setup 1"
- Setting the Pr6.18 values of adjacent amplifiers to different values (example: 0.0 s and 0.1 s).

Class	No.	Attribute *1)	Title	Range	Unit	Function
6	18	R	Power-up wait time	0-100	0.1 s	Set up the standard initialization time approx. 1.5 s + α (setting value \times 0.1s) after power-up. For example, in the case of the preset value 10, it is set to 1.5s+(10 \times 0.1 s) = approx. 2.5s. * If the period until LINK establishment is too long, this phenomenon may be improved by setting the Pr6.18 values for adjacent amplifiers to different values (for example, 0.0 s and 0.1 s).
7	22	R	Communication function extended setup 1	-32768– 32767	–	bit11 : Link establishment mode selection 0 : mode0, 1 : mode1 If link establishing is late, it might be improved by changing the setting.

*1) Refer to Section 9-1 for parameter attribute.

3-4 Monitor signal output function

Cannot be used with [V frame].

2 types of analog signals can be output for monitoring from the analog monitor connectors (X7) in the front panel. Types of monitor and scaling (output gain setting) can be set by the parameters below.

■ Relevant parameters

Class	No.	Attribute *1)	Title	Range	Unit	Function
4	16	A	Type of analog monitor 1	0-30 *2)	—	Select the type of monitor for analog monitor 1. * See the next page.
4	17	A	Analog monitor 1 output gain	0-214748364	[Monitor unit in Pr 4.16] / V	Set up the output gain of analog monitor 1. For Pr 4.16 = 0 Motor velocity, 1 V is output at the motor velocity [r/min] = Pr 4.17 setup value.
4	18	A	Type of analog monitor 2	0-30 *2)	—	Select the type of monitor for analog monitor 2. *See the next page.
4	19	A	Analog monitor 2 output gain	0-214748364	[Monitor unit in Pr 4.18] / V	Set up the output gain of analog monitor 2. For Pr 4.18 = 4 Torque command, 1 V is output at the torque command [%] = Pr 4.19 setup value.
4	21	A	Analog monitor output setup	0-2	—	Select output format of the analog monitor. 0: Signed data output -10 V to 10 V 1: Absolute value data output 0 V to 10 V 2: Data output with offset 0 V to 10 V (5 V at center)

*1) Refer to Section 9-1 for parameter attribute.

*2) In the enhanced version 4 and earlier, the setting range is 0 to 28.

(1) Pr 4.21 Analog monitor output setup:

Figure below shows output specification when Pr 4.21 is 0, 1 or 2.

Pr 4.21 = 0, signed data output
(output range -10 to 10 V)

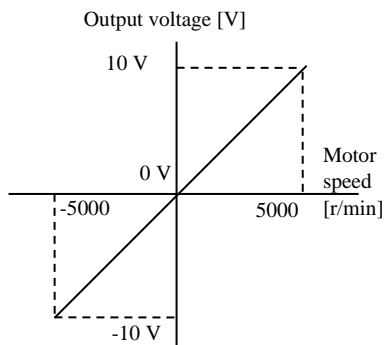

Pr 4.21 = 1, absolute value data output
(output range 0 to 10 V)

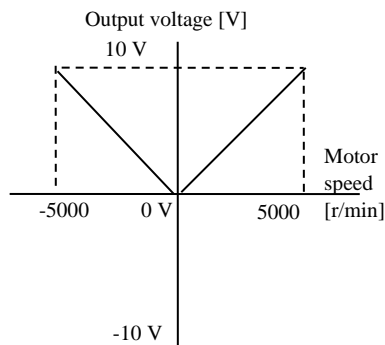

Pr 4.21 = 2, data output with offset
(output range 0 to 10 V)

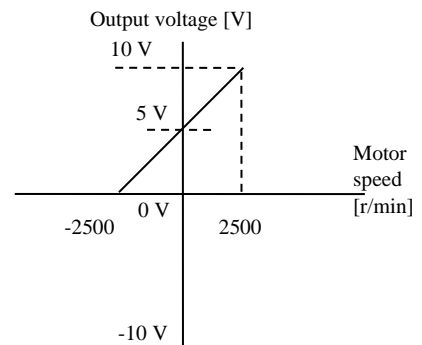

• When monitor type is motor speed, and conversion gain is 500 (1 V = 500 r/min).

(2) The table below shows types of monitor set in Pr 4.16 “Type of analog monitor 1” and Pr 4.18 “Type of analog monitor 2”. Pr 4.17 “Analog monitor 1 output gain” and Pr 4.19 “Analog monitor 2 output gain” respectively set the conversion gain in accordance to the unit suitable for the type. When the gain is set to 0, the gain shown at the right end column of the table is automatically applied.

Pr 4.16/Pr 4.18	Type of monitor	Unit	Output gain for setting Pr 4.17/Pr 4.19 = 0
0	Motor velocity	r/min	500
1	Positional command velocity *2	r/min	500
2	Internal positional command velocity *2	r/min	500
3	Velocity control command	r/min	500
4	Torque command	%	33
5	Command positional deviation *3	pulse (Command unit)	3000
6	Feedback scale deviation *3	pulse (Feedback scale unit)	3000
7	Reserved	—	—
8	Reserved	—	—
9	Voltage across PN	V	80
10	Regenerative load factor	%	33
11	Overload factor	%	33
12	Positive direction torque limit	%	33
13	Negative direction torque limit	%	33
14	Speed limit value	r/min	500
15	Inertia ratio	%	500
16	Reserved	—	—
17	Reserved	—	—
18	Reserved	—	—
19	Reserved	—	—
20	Driver temperature	°C	10
21	Reserved	—	—
22	Reserved	—	—
23	Travel command status *4	—	—
24	Gain selection status *4	—	—
25	Positioning complete state *6	0: Positioning not completed 1: Positioning completed	—
26	Alarm triggered state *6	0: Alarm not triggered 1: Alarm triggered	—
27	Motor power consumption	W	100
28	Amount of motor power consumption *5	Wh	100
29	For manufacturer's use	—	—
30	For manufacturer's use	—	—

*1 In principle, the positive/negative direction of the monitor data follows the Polarity setting.

- *2 For the command pulse input, the speed before the command filter (smoothing, FIR filter) is defined as positional command velocity and speed after filter is defined as internal command velocity.

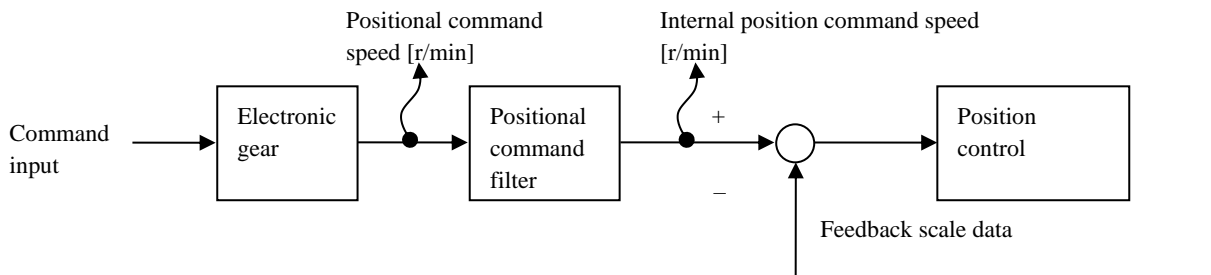

- *3 The calculation methods (standard) of a position deviation differ by EtherCAT communication and analog monitor, PANATERM.
 EtherCAT communication serves as a deviation to the instruction input before a position instruction filter.
 On the analog monitor and PANATERM, switchover is accomplished as follows according to the setting for the command position deviation output switching (bit 14) of Pr7.23 "Communication function Extended setup 2".
 Pr7.23 bit14=0: Deviation with respect to command input after positional command filter
 Pr7.23 bit14=1: Deviation with respect to command input before positional command filter

The figure below shows details.

Position deviation (Command unit) of analog monitor and PANATERM (For Pr7.23 bit14=0)

The position deviation(Command unit) of EtherCAT communication 4F01h(Following error actual value(after filtering))

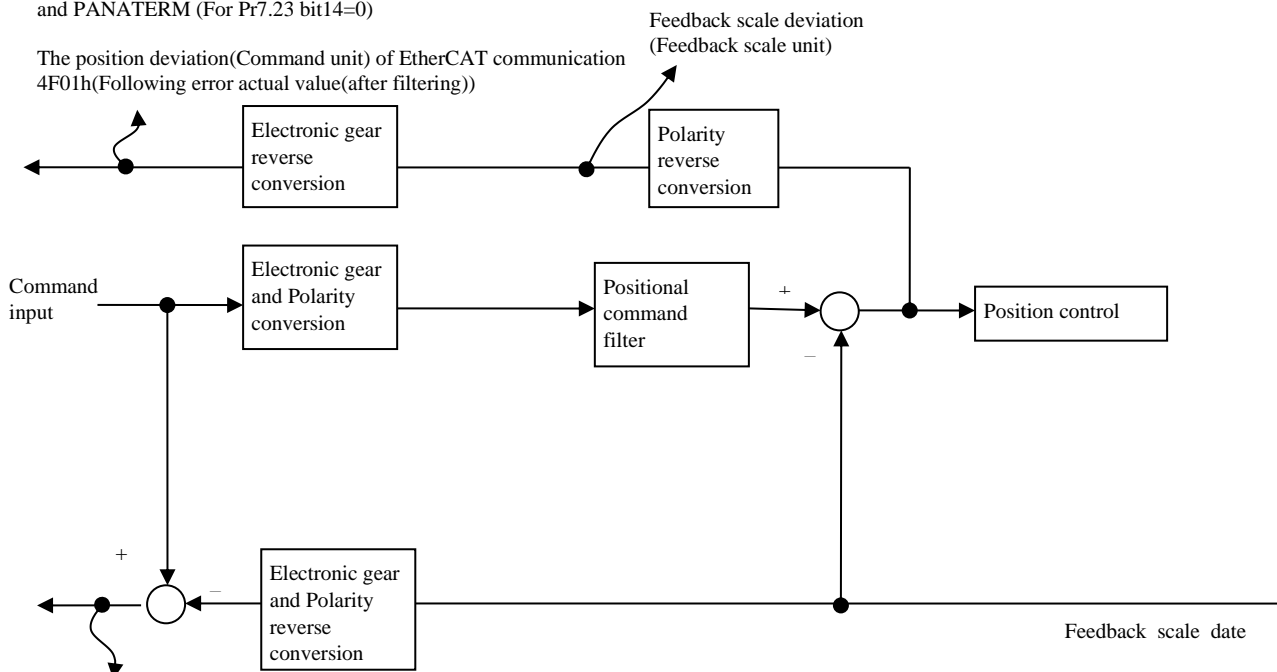

Position deviation(Command unit) of analog monitor and PANATERM (For Pr7.23 bit14=1)

The position deviation(Command unit) of EtherCAT communication 60F4h(Following error actual value)

- *4 For the monitor types No.23 and 24, digital signals are monitored using an analog monitor.
So, regardless the value of Pr4.17 “Analog monitor 1 output gain” and Pr4.19 “Analog monitor 2 output gain”, the output gain is as follows:

Pr4.16 /Pr4.18	Monitor type		Output voltage	
			0 [V]	+5 [V]
23	Travel command status	Profile Position control(pp)	250us interval Travel command ≠ 0	250us interval Travel command = 0
		Cyclic Position control(csp)	Communication cycle interval Travel command ≠ 0	Communication cycle interval Travel command = 0
		Velocity control	Velocity command ≠ 0	Velocity command = 0
		Torque control	Torque command ≠ 0	Torque command = 0
24	Gain selection status	2nd gain (Including 3rd gain)	1st gain	

※ The output of travel command status in position control(pp, csp) is different from those of the MINAS-A5B series.

- *5 The amount of motor power consumption per 30 minutes is output. The value is updated after the elapse of 30 minutes.
(Example) In the case of operation for 30 minutes with a motor power consumption of 10W
 $10[\text{W}] \times 0.5[\text{h}] = 5[\text{Wh}]$

- *6 Regardless of the setting for Pr4.17 and Pr4.19, the output become 0V at Unit 0 and 5V at Unit 1.

3-5 Station alias

Station alias can be set up by the following three methods.

- 1) Reading the value of SII from Configured Station Alias
Reading the value of 0004h(Configured Station Alias) in the SII from 0012h(Configured Station Alias) of ESC register.
- 2) Reading the value of rotary switch from Configured Station Alias
※Cannot be used in V frame
Reading the value made of object 3740h(Station alias setup(high)) and front panel rotary switch from 0012h(Configured Station Alias) of ESC register.
- 3) Reading the value of rotary switch from AL Status Code (Explicit Device ID)
※Cannot be used in V frame
Reading the value made of object 3740h(Station alias setup(high)) and front panel rotary switch from AL Status Code(0134h).

Please refer to 3-8-2 clause "Node addressing (Setting Station alias)" by technical document -EtherCAT communication specification- (SX-DSV03307) for details.

• Selection of Station alias

Class	No.	Attribute *1)	Parameter	Setting range	Unit	Function								
7	40	R	Station alias setting (upper)	0 - 255	—	Set the upper 8 bits of station alias.								
7	41	R	Station alias selection	0 - 2	—	<table border="1"> <thead> <tr> <th>Value</th> <th>Function</th> </tr> </thead> <tbody> <tr> <td>0</td> <td>Setting by rotary switch on front panel, and by Pr7.40 will be station alias.</td> </tr> <tr> <td>1</td> <td>Value of SII area (0004h) will be station alias.</td> </tr> <tr> <td>2</td> <td>For manufacturer's use</td> </tr> </tbody> </table>	Value	Function	0	Setting by rotary switch on front panel, and by Pr7.40 will be station alias.	1	Value of SII area (0004h) will be station alias.	2	For manufacturer's use
Value	Function													
0	Setting by rotary switch on front panel, and by Pr7.40 will be station alias.													
1	Value of SII area (0004h) will be station alias.													
2	For manufacturer's use													

4. Basic function

4-1 Rotational direction setup

Polarity (Rotational direction) can be set up to position command / velocity command / torque command, and each offset.

In the MINAS-A6BL series, the rotational direction cannot be set by Pr0.00 (Rotational direction setting), but it can be set by the object 607Eh (Polarity) specified to CoE (CiA402).

Please refer to section 6-9-4 "3) Polarity(607Eh)" of Technical Document "EtherCAT Communication Specifications" (SX-DSV03307) for details of object 607Eh (Polarity).

Setting value	Contents
0	No reverse of sign of objects related to torque, velocity, and position
224	Reverse of sign of objects related to torque, velocity, and position
Other than above	Not supported (Do not set)

In addition, object 607Eh (Polarity) is not what replaced parameter Pr0.00(Rotational direction setting) as it was, it becomes effective when performing the following data transfer between a CoE (CiA402) process division and a motor control process division.

- < Instructions / setting >
 - 607Ah(Target position)
 - 60B0h(Position offset)
 - 60FFh(Target velocity)
 - 60B1h(Velocity offset)
 - 6071h(Target torque)
 - 60B2h(Torque offset)
- <Monitor >
 - 4F04h(Position command internal value(after filtering))
 - 6062h(Position demand value)
 - 6064h(Position actual value)
 - 606Bh(Velocity demand value)
 - 606Ch(Velocity actual value)
 - 6074h(Torque demand)
 - 6077h(Torque actual value)
 - 6078h(Current actual value)
- < External input >
 - 60FDh(Digital input) bit1(positive limit switch(POT))
 - 60FDh(Digital input) bit0(negative limit switch(NOT))
 - External input (POT/NOT)

The setting of 607Eh (Polarity) is reflected on data on the setup support tool PANATERM, in addition to the above data.

And the settings of 607Eh (Polarity) is reflected on POT/NOT during execution by PANATERM including test run function, frequency response analyzing function and Z phase search function. Be careful that these operations are different from those of the MINAS-A5BL series.

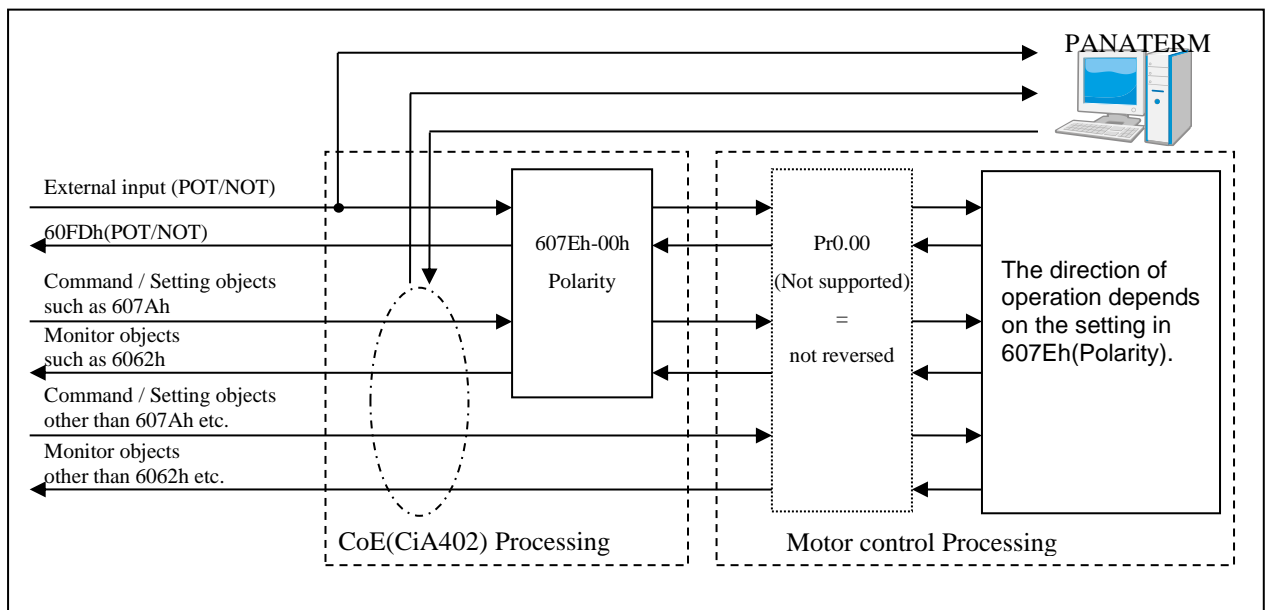

4-2 Position control

Control the position based on the positional command of EtherCAT communication object from the host controller. Below describes the basic settings necessary for position control.

The control mode is switched forcibly inside the driver depending on its operating status irrespective of the command from the host controller.

[Conditions that the control mode is switched forcibly inside the driver]

- When frequency characteristic is measured by Setup support software.
(Position loop characteristics is position control, the speed closed loop characteristic and torque speed (vertical) are speed control, torque speed (normal) is torque control.)
- Test run of the setup support software (Forcibly position control mode).
- The states that are written "Forcibly controls the position" in "Deceleration stop sequence" (Section 6-3).
- "Retracting operation" in operation (Forcibly controls the position)

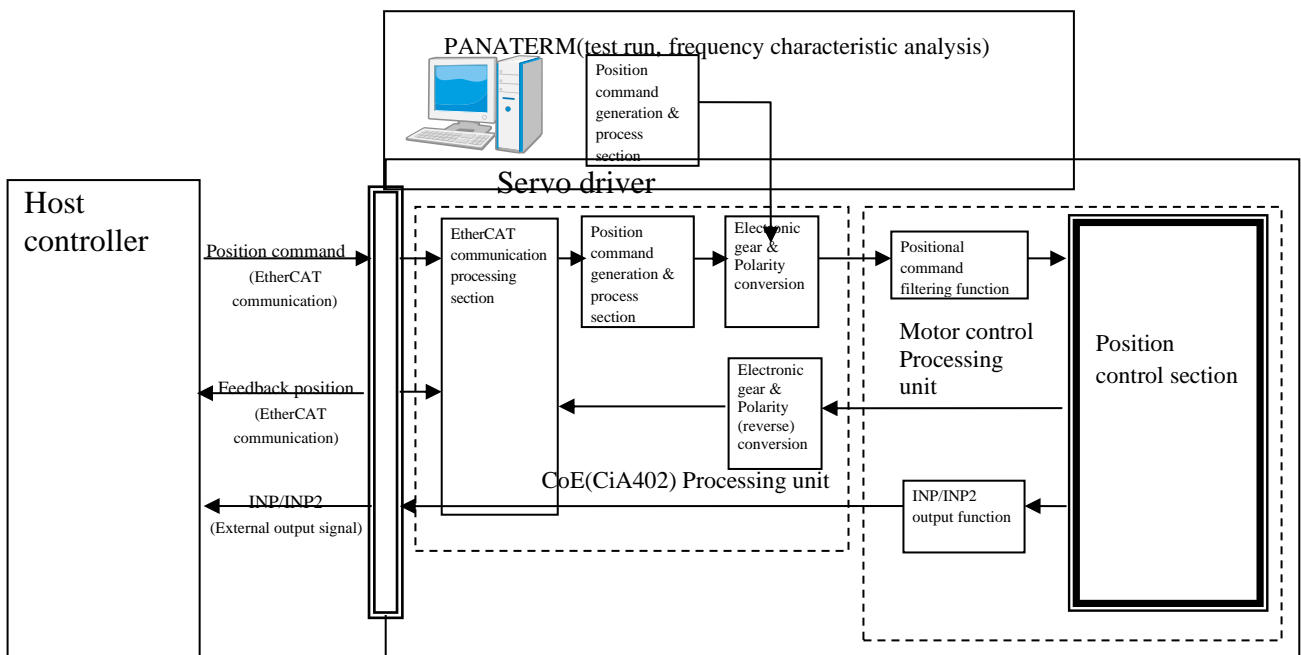

4-2-1 Process of command pulse input

Positional command is input based on the EtherCAT communication object.

As position control modes, Profile position control (pp), Cyclic position control (csp), Interpolated position (ip) (Not supported), and Homing position (hm) are available.

For details, refer to Technical Reference, SX-DSV03307"Section 6-6", EtherCAT communication specification.

4-2-2 Electronic gear function

The electronic gear is a function which makes the value which multiplies by the electronic gear ratio defined by the object to the position command from host controller as the position command to a position control section. By using this function, the number of revolutions and travel of the motor per command can be set to the desired value.

In MINAS-A6BL series, a setup of an electronic gear ratio with a parameter Pr0.08(Number of command pulses per motor revolution), Pr0.09(Numerator of electronic gear) and Pr0.10(Denominator of electronic gear) has not supported, an electronic gear ratio is set up by the object 608Fh(Position encoder resolution), 6091h(Gear ratio) and 6092h(Feed constant) specified to CoE(CiA402).

The equation below calculates the relationship between the unit (command) defined by the user and internal unit (pulse):

$$\text{Electronic gear ratio} = \frac{\text{Position encoder resolution} \times \text{Gear ratio}}{\text{Feed constant}}$$

$$\text{Position demand value} \times \text{Electronic gear ratio} = \text{Position demand internal value}$$

- (Note)
- Electronic gear ratio is valid only within the range of 8000 times to 1/1000 times.
When the range is exceeded, the value is saturated in the range, and Err88.3 (Improper operation error protection) occurs.
 - When the denominator or numerator exceeds the unsigned 64-bit size in the calculation process of electronic gear ratio, Err88.3 (Improper operation error protection) occurs.
 - When the denominator or numerator exceeds the unsigned 32-bit size in the final calculation result of electronic gear ratio, Err88.3 (Improper operation error protection) occurs.
 - Set the electronic gear ratio with several objects.
An error may become large depending on the combination of settings.
 - 608Fh-01h (Encoder increments) and 608Fh-02h (Motor revolutions) are automatically set up as shown in the table below, depending on the feedback scale resolution.

	Linear type (linear)	Rotary type (rotary)
608Fh-01h (Encoder increments)	1,000,000 (fixed)	Resolution per rotation [p/r] *1)
608Fh-02h (Motor revolutions)	Feedback scale resolution [nm/p] *1)	1 (fixed)

*1) The setting value for Pr9.01 "Feedback scale resolution/scale pulse number per rotation" is automatically specified. However, it may vary from the setting value in Pr9.01 in case Err60.0 "Motor setup error protection" occurs.

In addition, the shipment value for 6092h-01h (Feed) is set so that the electronic gear ratio is 1:1 when feedback scale is used with a linear type and resolution 1 nm/p (Pr9.01 = 1).

When using a rotary type or when using feedback scale with resolution value other than 1 nm/p with a linear type, due caution is required in electronic gear ratio setting.

- The electronic gear ratio setting is reflected at the following timing.
Pay attention that the setting is not reflected to behavior just by only changing setting value of related objects.
 - At the time of the control power supply ON
 - When establishing communication (when changing ESM state from Init to PreOP)
 - When returning to origin is completed
 - When clearing absolute multi-turn from PANATERM or EtherCAT communication
 - When PANATERM operation(test run function, frequency response analyzing function, Z phase search, fit gain) is completed.
 - When execute pin assign by PANATERM.
 - When Err27.4 (Command error protection) occurs

- In the position information initialization when Init to PreOp in the absolute mode, make a setting so that the value of "Absolute feedback scale position [pulse/unit]/Electronic gear ratio" is in the range from -2^{31} (-2147483648) to $+2^{31}-1$ (2147483647).
If the value is exceeded this range, Err29.1(Counter overflow protection 1) will occur.
Check the operation range of the absolute feedback scale position and the electronic gear ratio.
- The unit of the movement amount setting of the test run function by the setup support tool PANATERM is [command unit].
Pay attention that this is different from those of the MINAS-A5BL series.
- Communication cycle 125 μ s is supported only if the electronic gear ratio is 1:1.
Operations when the electronic gear ratio is other than 1:1 are not guaranteed.

For details, refer to Technical Reference, SX-DSV03307"Section 6-9-4", EtherCAT communication specification.

<Electronic gear setting example>

In MINAS-A6BL series, it is impossible to set the electronic gear using the “number of command pulses per motor revolution (Pr0.08)” and “electronic gear numerator (Pr0.09)/denominator (Pr0.10)” in contrast to MINAS-A6NL series.

When setting the electronic gear like the MINAS-A6NL, refer to the following.

$$\text{Electronic gear ratio} = \frac{\frac{\text{Encoder increments (608Fh-01h)}}{\text{Motor revolutions (608Fh-02h)}} \times \frac{\text{Motor shaft revolutions (6091h-01h)}}{\text{Driving shaft revolutions (6091h-02h)}}}{\frac{\text{Feed (6092h-01h)}}{\text{Driving shaft revolutions (6092h-02h)}}}$$

When setting the electronic gear ratio, 6091 h - 01 h (Motor shaft revolutions) and 6091 h - 02 h (Driving shaft revolutions) can set as the electronic gear numerator and electronic gear denominator by setting each object with reference to the following table.

Object name	Linear	Roatry
Encoder increments (608Fh-01h)	The value is automatically set to 1000000.	The value is automatically set in accordance with Pr9.01 (Pulse number per rotation).
Motor revolutions (608Fh-02h)	The value is automatically set in accordance with the feedback scale resolution.	The value is automatically set to 1.
Feed (6092h-01h)	Set to the same value as the encoder incremeets (608Fh-01h).	Set to the same value as the encoder incremeets (608Fh-01h).
Driving shaft revolutions (6092h-02h)	Set to the same value as the motor revolutions (608Fh-02h).	Set to the same value as the motor revolutions (608Fh-02h).

$$\text{Electronic gear ratio} = \frac{\text{Motor shaft revolutions (6091h-01h)}}{\text{Driving shaft revolutions (6091h-02h)}}$$

It can be set as the electronic gear numerator.

It can be set as the electronic gear denominator.

<Backup of electronic gear set value>

The electronic-gear-related objects (6091h-01h, 6091h-02h, 6092h-01h and 6092h-02h) are backup target objects.

It is recommended to execute a backup (writing into EEPROM) after a change.

By executing a backup, it will be unnecessary to change setting each time when the control power is turned on.

As for the backup method, refer to Technical Reference, EtherCAT communication specification(SX-DSV03307) Section 5-6 “Store parameters (EEPROM writing of objects) (1010h)”.

<Electronic gear setting and backup by object editor>

It is possible to set and back up objects using the object editor of PANATERM.

For the MINAS-A5BL series, it was necessary to turn the control power ON again after backing up to reflect the setting value changed by using the object editor.

For the MINAS-A6BL series, the setting values by using the object editor are reflected to actual objects, and setting of electronic gear ratio is reflect to actual behavior at following timing same as previously via EtherCAT:

- At the time of the control power supply ON
- When establishing communication (when changing ESM state from Init to PreOP)
- When returning to origin is completed
- When clearing absolute multi-turn from PANATERM or EtherCAT communication
- When PANATERM operation(test run function, frequency response analyzing function, Z phase search, fit gain) is completed.
- When execute pin assign by PANATERM.

Pay attention that the changes of the setting values are reflected on operations even if the control power is not turned ON after backup unlike the behavior of the MINAS-A5BL series.

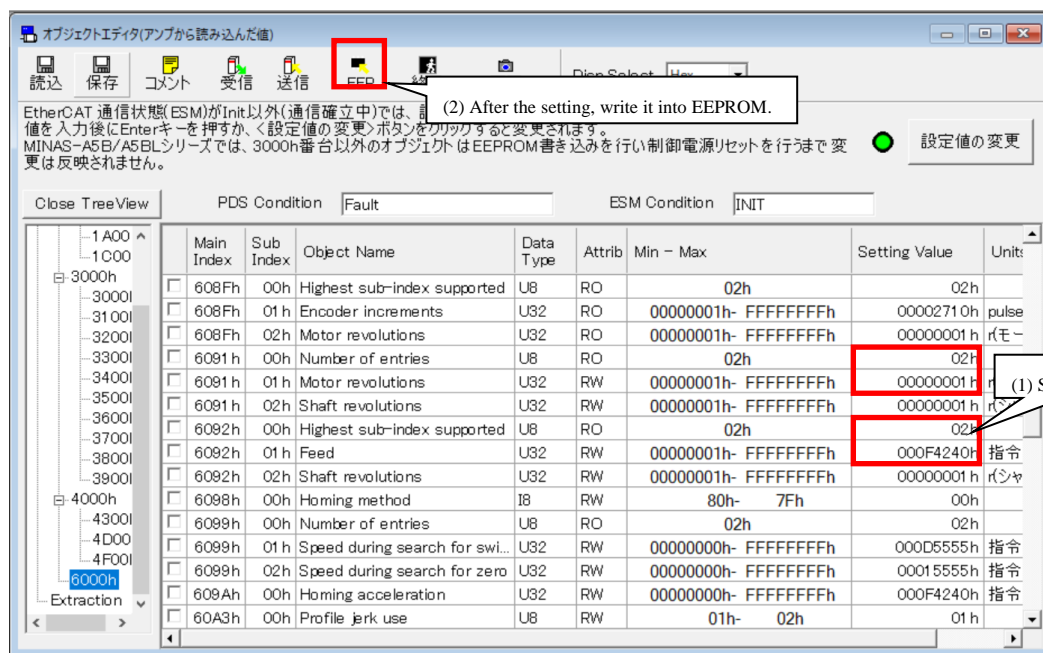

4-2-3 Positional command filtering function

To smooth the positional command processed by the electronic gear, set the command filter.

■ Relevant parameters

Class	No.	Attribute *1)	Title	Range	Unit	Function
2	22	B	Positional command smoothing filter	0–10000	0.1 ms	Set up the time constant of the 1st delay filter in response to the positional command. With the two-degree-of-freedom control, it functions as the command response filter. For the details, refer to 5-2-16 "Two-degree-of-freedom control mode (With position control)" and 5-2-17 "Two-degree-of-freedom control mode (With velocity control)"
2	23	B	Positional command FIR filter	0–10000	0.1 ms	Set up the time constant of the FIR filter in response to the positional command

*1) For parameter attribute, refer to Section 9-1.

• Pr 2.22 Positional command smoothing filter

During conventional control, when a square wave command for the target speed V_c is applied, set up the time constant of the 1st delay filter as shown below. Set the time constant for the command filter during 2 degrees of freedom control.
For details, refer to Section 5-2-16, 5-2-17, and 5-2-18.

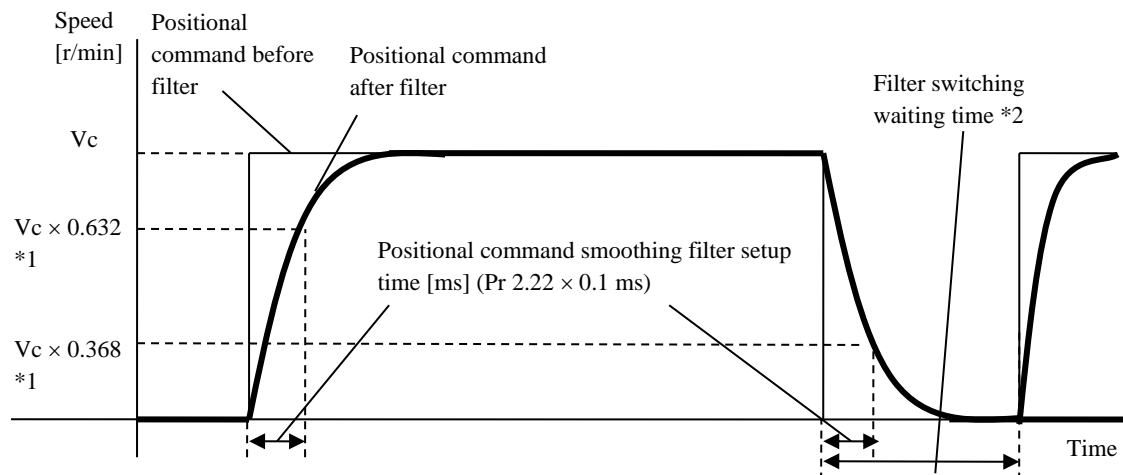

*1 Actual filter time constant (setup value \times 0.1 ms) has the maximum absolute error of 0.4 ms for a time constant below 100 ms and the maximum relative error of 0.2% for a time constant 20 ms or more.

*2 Switching of Pr 2.22 Positional command smoothing filter is performed on the rising edge of the command with the number of command pulses/0.125 ms is changed from 0 to a value other than 0 while the positioning complete is being output.

Even if the control mode is changed to position control after Pr2.22 (Positional command smoothing filter) setting is changed during velocity control or torque control, the setting is not changed.

If the filter time constant is decreased and positioning complete range is increased, and a many number of pulses are accumulated in the filter (the area equivalent of “value of positional command before filter–value of positional command after filter” integrated over the time), at the time of switching, these pulses are discharged at a higher rate, causing the motor to return to the previous position—the motor runs at a speed higher than the command speed for a short time.

*3 Even if setting of Pr2.22 (Positional command smoothing filter) is changed, it is not immediately applied to the internal calculation. If the switching as described in *2 occurs during this delay time, the change of Pr2.22 will be suspended.

- Pr2.23 Positional command FIR filter

When a square wave command of target speed V_c is applied, set up the V_c arrival time as shown in the figure below.

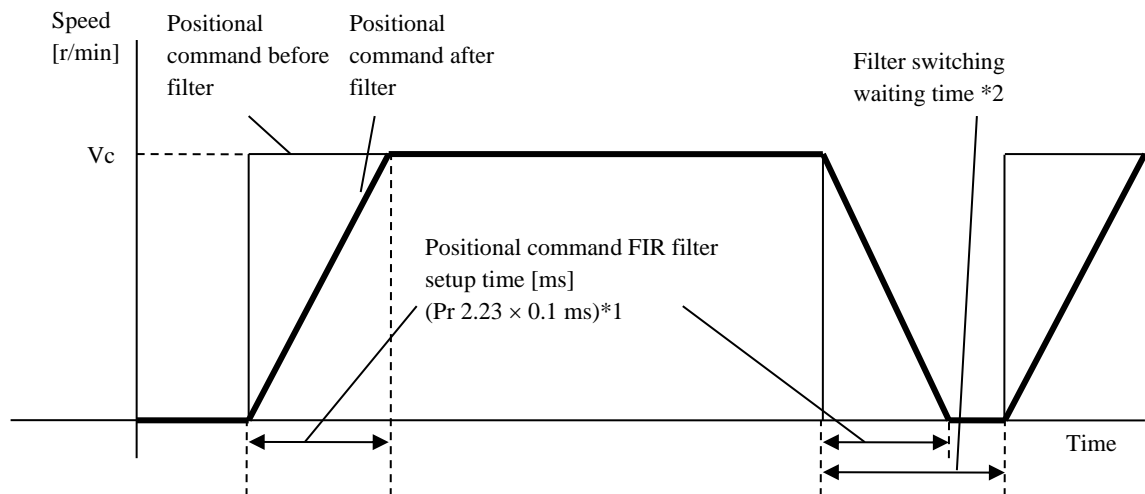

- *1 The actual average travel time (setup value \times 0.1 ms) has the maximum absolute error of 0.2 ms for a time constant below 10 ms and the maximum relative error of 1.6% for a time constant 10 ms or more.
- *2 When changing the setting of Pr2.23 (Positional command FIR filter), stop the command pulse and wait until the filter switching wait time has elapsed. The filter switching wait time will be setup value \times 0.1 ms + 0.25 ms when the setup time is below 10 ms, or setup value \times 0.1 ms \times 1.05 when the setup time is over 10 ms. If Pr 2.23 is changed during the command pulse is being input, the change is not reflected until the command pulse-less state has continued for the filter switching wait time. Change will be reflected after the control power reset.
- *3 Even if setting of Pr2.23 (Positional command FIR filter) is changed, it is not immediately applied to the internal calculation. If the switching as described in *2 occurs during this delay time, the change of Pr2.23 will be suspended.

When the positional command is trapezoidal wave, its waveform will be shaped to S at the output of the filter.

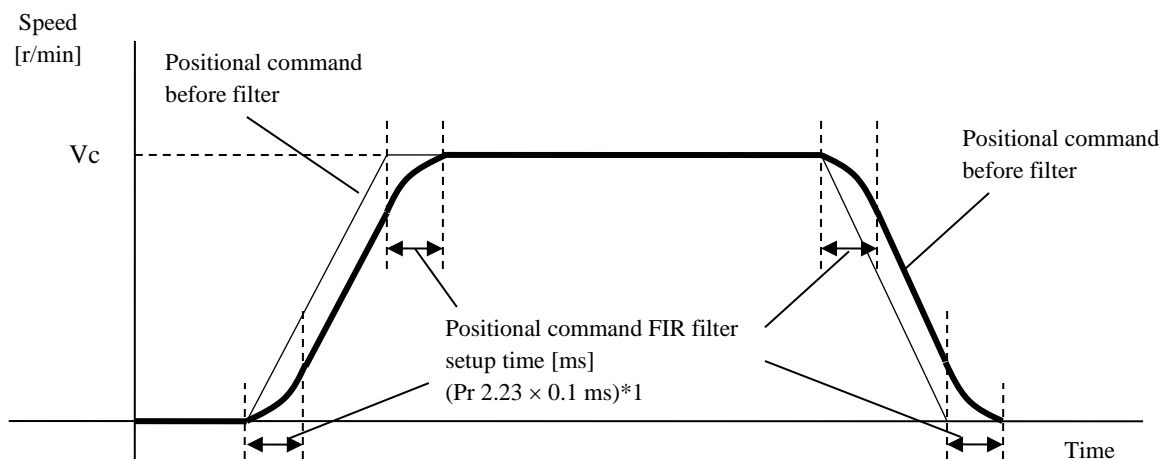

4-2-4 Positioning complete output (INP/INP2) function

The completion of positioning can be verified by the positioning complete output (INP) or the positioning complete output 2 (INP2).

When the absolute value of the positional deviation counter at the position control is equal to or below the positioning complete range by the parameter, the output is ON. Presence and absence of positional command can be specified as one of judgment conditions.

The calculation methods (standard) of a position deviation differ as follows according to the setting for the command position deviation output switching (bit 14) of Pr7.23 "Communication function Extended setup 2".

For details, refer to Section 3-4.

Pr7.23 bit14=0: Deviation with respect to command input after positional command filter

Pr7.23 bit14=1: Deviation with respect to command input before positional command filter

However, it becomes available when Pr5.20(Position setup unit select) is 0.

Note: The "positional deviation" written in this section is that of the motor control process part (on PANATERM and analog monitor), not 60F4h (Following error actual value) on the EtherCAT communication.

■ Relevant parameters

Class	No.	Attribute *1)	Title	Range	Unit	Function
4	31	A	Positioning complete (In-position) range	0-2097152	Command unit	Set the threshold of positional deviation with respect to the output of positioning complete signal (INP). The unit of shipment setting is [Command unit], but it can be changed to [Feedback scale unit] by Pr5.20(Position setup unit select). In this case, the unit of Pr0.14 is changed too, please attention. The positional deviation value can be changed to after or before position command filter by Pr7.23 bit14.
4	32	A	Positioning complete (In-position) output setup	0-10	—	Select the condition to output the positioning complete signal (INP). Whether or not positional commands are set is judged by the command after the positional command filter in the case of settings 1 to 5, and the command before the positional command filter in the case of 6 to 10. For the value of the position deviation it is possible to switch before or after the position command filter by Pr7.23 bit14. 0: The signal will turn on when the positional deviation is smaller than Pr 4.31 (Positioning complete range) 1, 6 :The signal will turn on when there is no position command and the positional deviation is smaller than Pr 4.31 (Positioning complete range). 2, 7 :The signal will turn on when there is no position command, the zero-speed detection signal is ON and the positional deviation is smaller than Pr 4.31 (Positioning complete range). 3, 8 :The signal will turn on when there is no position command and the positional deviations smaller than Pr 4.31 (Positioning complete range). Subsequently, ON state is maintained until Pr 4.33 INP hold time has elapsed. After the hold time, INP output will be turned ON/OFF according to the coming positional command or condition of the positional deviation. 4, 9 :Positioning completion decision starts in a delay time specified by Pr4.33 after a change from "With command" to "Without command". The signal turns on if position command is not received and position deviation is not larger than Pr4.31. 5,10 :After "With position command" changes to "Without position command" and then the positional deviation enters the positioning complete range, positioning completion decision is started upon the elapse of the positioning determination delay time specified for Pr4.33 "INP hold time". The signal turns on when there is no position command and the positional deviation is equal to smaller than Pr 4.31 "Positioning complete range".

Class	No.	Attribute *1)	Title	Range	Unit	Function
4	33	A	INP hold time	0-30000	ms	<p>Set up the hold time when Pr 4.32 = 3, 8.</p> <p>0: The hold time is maintained definitely, keeping ON state until the next positional command is received.</p> <p>1 to 30000: ON state is maintained for setup time (ms) but switched to OFF state as the positional command is received during hold time.</p> <p>Becomes positioning detection delay time when Pr4.32 = 4, 5, 9, 10.</p> <p>0: Positioning detection delay time becomes 0, and positioning completion decision is started immediately upon a change from "With position command" to "Without position command".</p> <p>1 to 30000: Positioning decision start time is delayed by a setting value [ms]. If a position command is received during the delay time, the delay time is reset. When the position command becomes 0, the delay time starts to be measured starting from 0.</p>
4	42	A	Positioning complete (In-position) range 2	0-2097152	Command unit	<p>Set the threshold of positional deviation with respect to the output of positioning complete (INP) signal.</p> <p>The INP2 turns ON whenever the positional deviation is lower than the value set up in this parameter, without being affected by Pr 4.32</p> <p>Positioning complete output setup. (Presence/ absence of positional command is not related to this judgment.)</p> <p>The unit of shipment setting is [Command unit], but it can be changed to [Feedback scale unit] by Pr5.20(Position setup unit select).In this case, the unit of Pr0.14 is changed too, please attention.</p> <p>The positional deviation value can be changed to after or before position command filter by Pr7.23 bit14.</p>
5	20	C	Position setup unit select	0-1	—	<p>Specify the unit to determine the range of positioning complete and excessive positional deviation.</p> <p>0: Command unit, 1: Feedback scale unit</p> <p>Note: Positioning complete(6041h bit10(Target reached)) detection threshold of EtherCAT communication status is always in terms of command unit regardless of the setting of this parameter.</p>
7	23	B	Communication function extended setup 2	-32768 -32767	—	<p>bit14: Position deviation [command unit] output setting</p> <p>0: Internal command position (after filtering) [command unit] – Actual position [command unit]</p> <p>1: Internal command position (before filtering) [command unit] – Actual position [command unit]</p>

*1) For parameter attribute, refer to Section 9-1.

4-2-5 Pulse regeneration function

The information on the amount of movement can be sent to the host controller in the form of A- and B-phase pulses from the servo driver. The resolution of information and B phase logic can be set up by using parameters. Z phase signal is not supported with pulse regeneration.

■ Relevant parameters

Class	No.	Attribute *1)	Parameter	Range	Unit	Function
0	11	R	Pulse output numerator	1-2097152	—	The dividing ratio can be set by using Pr. 0.11 as numerator and Pr. 5.03 as denominator. Consequently, the result of pulse count with host side $\times 4$ multiplication processing becomes as follows.
5	03	R	Pulse output denominator	0-8388608	—	Pulse output resolution per unit distance = (Pr. 0.11 setting value/Pr.5.03 setting value) \times Feedback scale resolution per unit distance
0	12	R	Reversal of pulse output logic	0-3	—	You can set up the B-phase logic and the output source of the pulse output. With this parameter, you can reverse the phase relation between the A-phase pulse and the B-phase pulse by reversing the B-phase logic.
4	47	R	Pulse output selection	0-1	—	Select the signal to be output from the pulse regeneration output terminal or position comparison output terminal. 0: Feedback scale output signal 1: Position comparison output signal
5	33	C	Pulse regenerative output limit setup	0-1	—	Enable/disable detection of Err28.0 "Pulse regenerative limit protection". 0: Invalid 1: Valid
6	22	R	A, B phase external scale pulse output method selection	0-1	—	Selects pulse regenerated output of ABZ parallel external scale. 0: Outputs AB phase signal from ABZ parallel external scale as is. 1: Regenerates and outputs AB phase signal from ABZ parallel external scale.

*1) For parameter attribute, refer to Section 9-1.

The table below shows combination of Pr0.11 “Output pulse counts per one motor revolution” and Pr5.03 “Denominator of pulse output division”.

Pr 0.11	Pr 5.03	Command division/multiplication operation
1-2097152	0	<p>Feedback scale [pulse] → $\frac{1}{1}$ → Output pulse [pulse]</p> <p>• When Pr.5.03 = 0, division ratio is 1:1.</p>
1-2097152	1-8388608	<p>Feedback scale [pulse] → $\frac{[\text{Pr.0.11 setting value}]}{[\text{Pr.5.03 setting value}]}$ → Output pulse [pulse]</p> <p>The resolution of output pulse does not become more than the resolution of feedback scale pulse. Please use under the setting that satisfies “Set value for Pr0.11 ≤ Set value for Pr5.03.”</p>

Table below shows details of Pr. 0.12 “Reversal of pulse output logic/output source selection”.

Pr 0.12	B-phase logic	Output source	At operation to positive direction	At operation to negative direction
0	Nonreversal	Feedback scale	A-phase	A-phase
2			B-phase	B-phase
1	Reversal	Feedback scale	A-phase	A-phase
3			B-phase	B-phase

■ Command on pulse regeneration function

- Maximum frequency of regenerated pulse output is 4 Mpps (after multiplied by 4), If the movement speed exceeds this frequency, the regeneration will not function correctly. That is, correct pulse is not returned to the host controller, causing positional deviation.

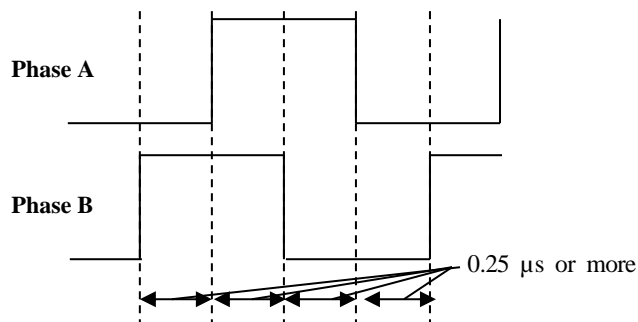

By enabling Pr5.33 “Pulse regenerative output limit setup”, Err28.0 “Pulse regenerative limit protection” can be generated upon reaching the pulse regeneration limit. Because this error is generated when the output limit of the pulse regeneration is detected, it is not generated at the maximum frequency. However, detection error may occur if the frequency instantaneously jumps up due to motor velocity change (irregular rotation).

- In pulse regeneration function, the setting value in Polarity (607Eh) at control power supply startup is reflected.

4-3 Velocity control

Carried out the speed control based on the speed command object EtherCAT communication which is input from the host controller.

This describe the basic configuration when using the speed control.

As the speed control mode, there is a Profile velocity control(pv) and Cyclic synchronous velocity control(csv). For details, refer to Technical Reference, SX-DSV03307"Section 6-7", EtherCAT communication specification.

The control mode is switched forcibly inside the driver depending on its operating status irrespective of the command from the host device. This operation has an effect on input signal processing.

[Conditions that the control mode is switched forcibly inside the driver]

- When frequency characteristic is measured by Setup support software.
(Position loop characteristics is position control, the speed closed loop characteristic and torque speed (vertical) are speed control, torque speed (normal) is torque control.)
- Test run of the setup support software (Forcibly position control mode).
- The states that are written "Forcibly controls the position" in "Deceleration stop sequence" (Section 6-3).
- "Retracting operation" in operation (Forcibly controls the position)

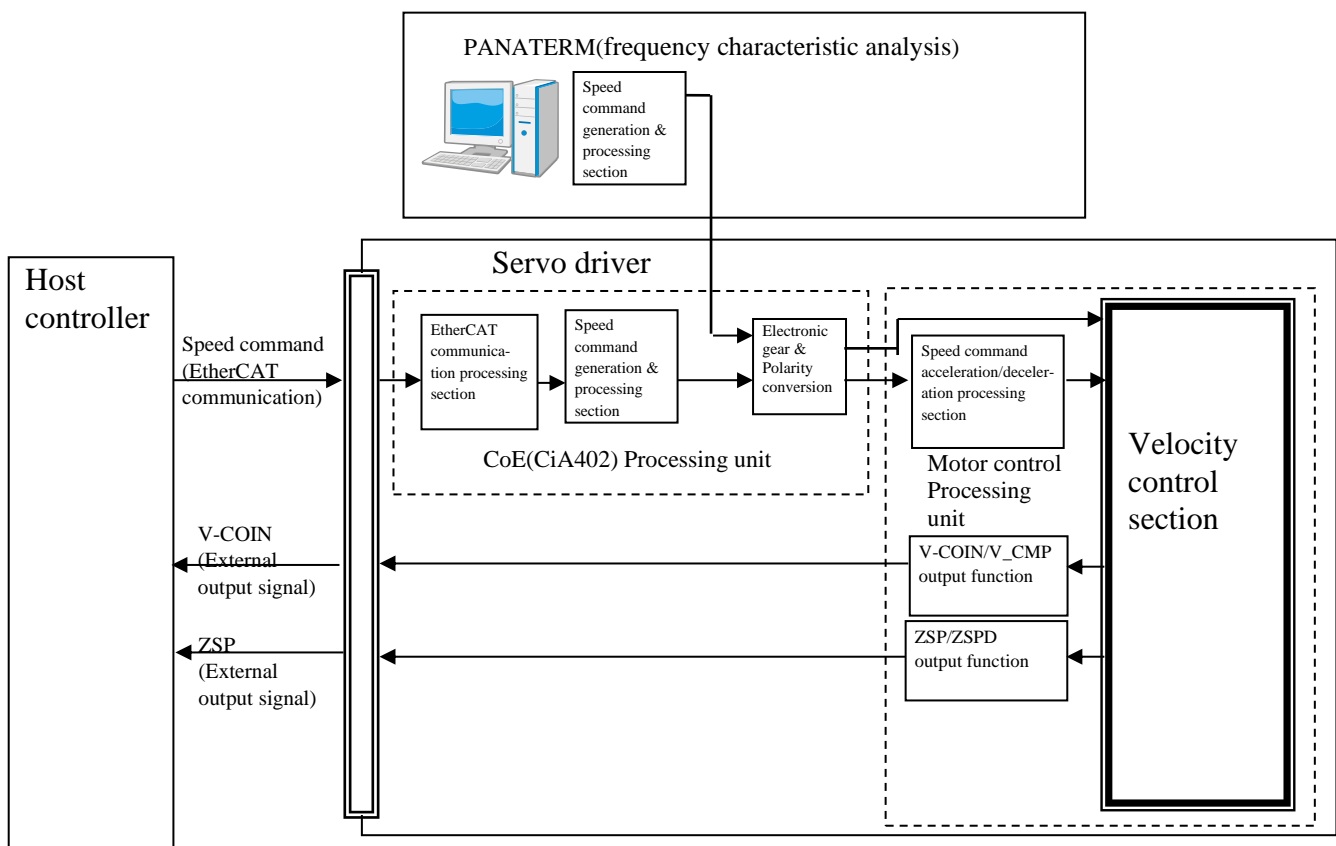

4-3-1 Attained speed output (AT-SPEED)

The AT-SPEED signal is output as the motor reaches the speed set to Pr 4.36 “Attained speed”.

■ Relevant parameters

Class	No.	Attribute *1)	Title	Range	Unit	Function
4	36	A	At-speed (Speed arrival)	10–20000	r/min	Set the detection timing of the speed arrival output (AT-SPEED). When the motor speed exceeds this setup value, the speed arrival output (AT-SPEED) is output. Detection is associated with 10 r/min hysteresis.

*1) For parameter attribute, refer to Section 9-1.

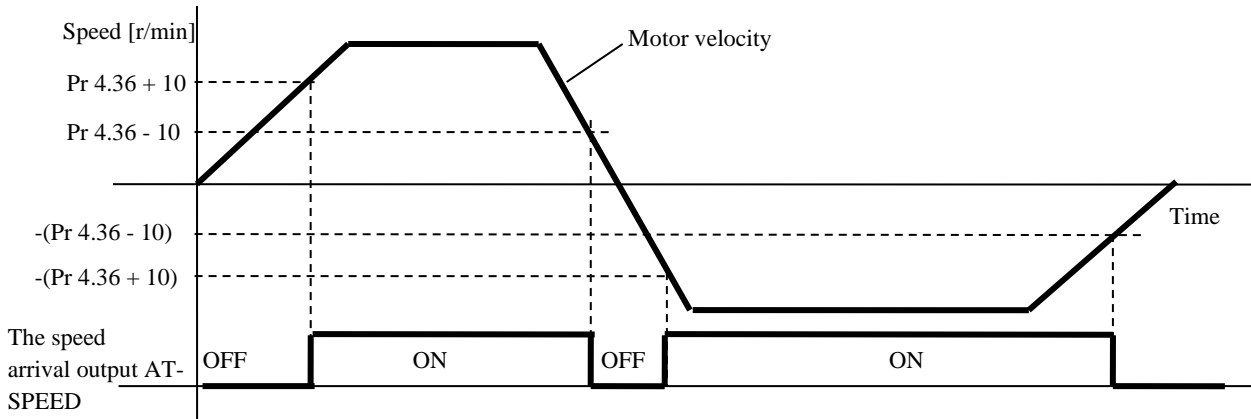

4-3-2 Speed coincidence output (V-COIN)

This signal is output when the motor speed is equal to the velocity specified by the velocity command. The motor speed is judged to be coincident with the specified speed when the difference from the velocity command before/after acceleration/deceleration is within the range specified by Pr 4.35 "Speed coincident range"

■ Relevant parameters

Class	No.	Attribute *1)	Title	Range	Unit	Function
4	35	A	Speed coincidence range	10–20000	r/min	Set the speed coincidence (V-COIN) output detection timing. Output the speed coincidence (V-COIN) when the difference between the speed command and the motor speed is equal to or smaller than the speed specified by this parameter. The detection response has 10 r/min hysteresis.

*1) For parameter attribute, refer to Section 9-1.

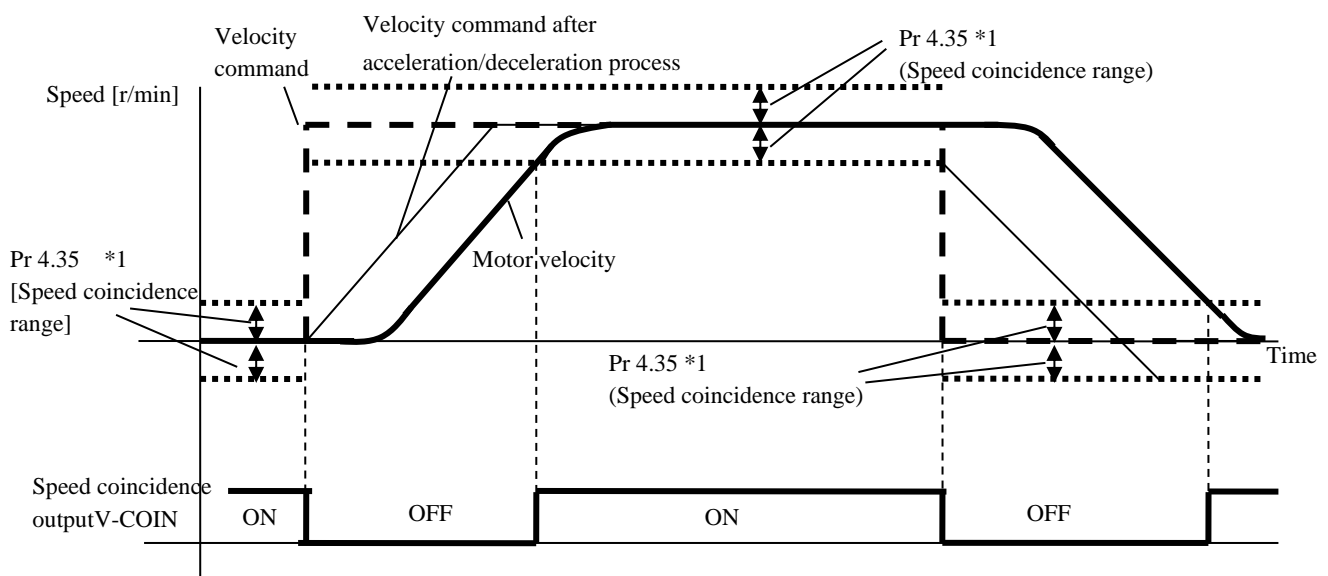

*1 Because the speed coincidence detection is associated with 10 r/min hysteresis, actual detection range is as shown below.

Speed coincidence output OFF ON timing (Pr 4.35 – 10) r/min

Speed coincidence output ON OFF timing (Pr 4.35 + 10) r/min

4-3-3 Velocity command acceleration/deceleration setting function

This function controls the velocity by adding acceleration or deceleration command in the driver to the input velocity command.

Using this function, you can use the soft start when inputting stepwise velocity command or when using internal velocity setup. You can also use S shaped acceleration/deceleration function to minimize shock due to change in velocity.

■ Relevant parameters

Class	No.	Attribute *1)	Title	Range	Unit	Function
3	12	B	Acceleration time setup	0-10000	ms/ (1000 r/min)	Set up acceleration processing time in response to the velocity command input.
3	13	B	Deceleration time setup	0-10000	ms/ (1000 r/min)	Set up deceleration processing time in response to the velocity command input.
3	14	B	Sigmoid acceleration/deceleration time setup	0-1000	ms	Set S-curve time for acceleration/deceleration process when the velocity command is applied.

*1) For parameter attribute, refer to Section 9-1.

Note: When the position loop is external to the driver, do not use the acceleration/deceleration time setting. Set these values to 0.

- Pr 3.12 “Acceleration time setup”, Pr 3.13 “Deceleration time setup”

Set the time, elapsing before the velocity command (stepwise input) reaches 1000 r/min after a stepwise velocity command is input, to Pr 3.12 “Acceleration time setup”. Also set the time, elapsing before the velocity command reaches 0 r/min from 1000 r/min, to Pr 3.13 “Deceleration time setup”. Assuming that the target value of the velocity command is V_c (r/min), the time required for acceleration/deceleration can be computed from the formula shown below.

$$\text{Acceleration time (ms)} = V_c/1000 \times \text{Pr 3.12} \times 1 \text{ ms}$$

$$\text{Deceleration time (ms)} = V_c/1000 \times \text{Pr 3.13} \times 1 \text{ ms}$$

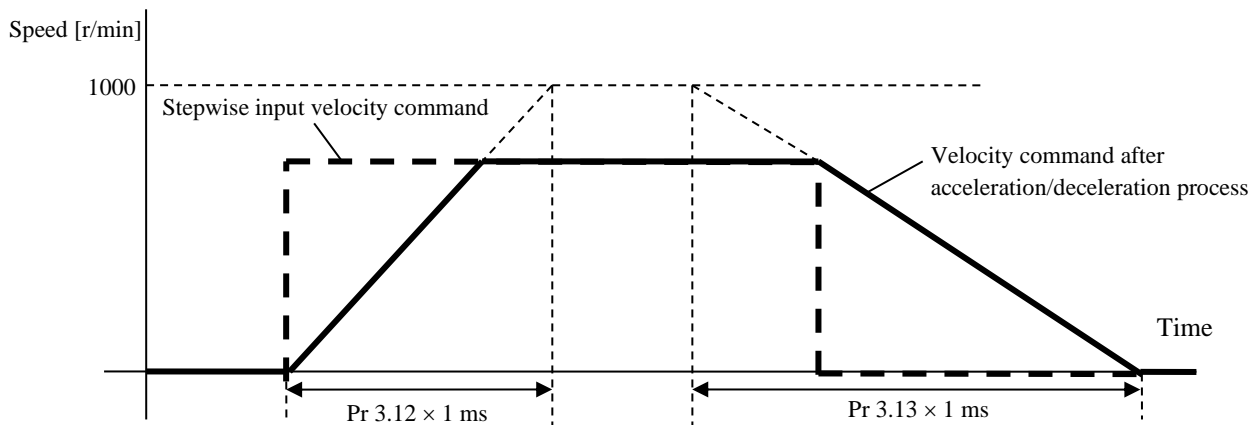

- Pr 3.14 “Sigmoid acceleration/deceleration time setup”

According to Pr 3.12 “Acceleration time setup” and Pr 3.13 “Deceleration time setup”, set up sigmoid time with time width centering the inflection point of acceleration/deceleration.

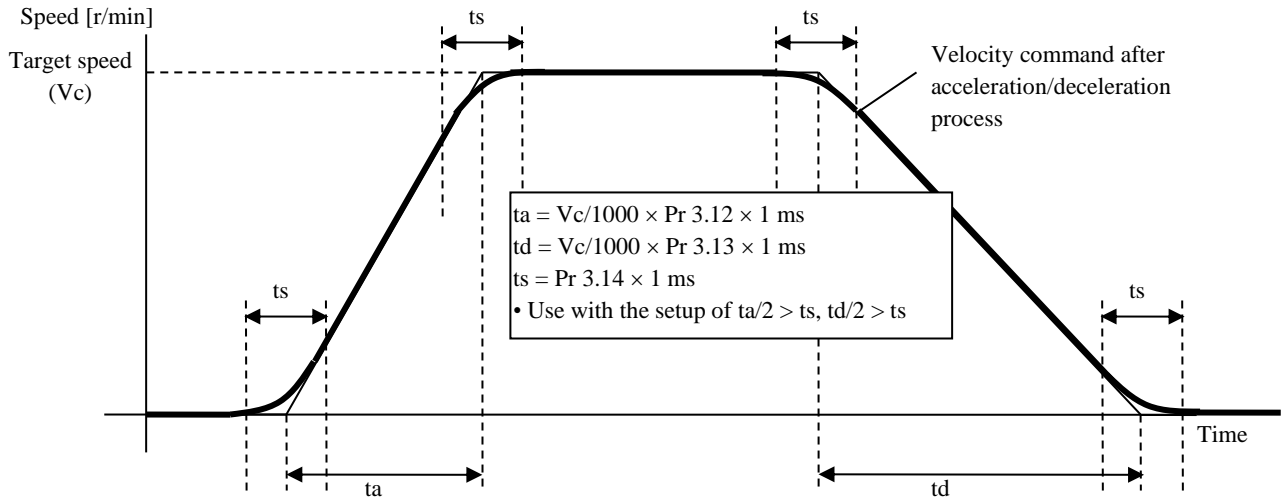

4-4 Torque control

Torque control is performed based on the torque command object of the EtherCAT communication which is input from the host controller.

This describe the basic configuration when using the torque control.

Torque control is required speed limit command in addition to the torque command.

Control the rotational speed of the motor so that the value does not exceed the speed limit.

Note) When a torque command is given so that 0 is routed through like a positive value to negative value or negative value to positive value while torque filter is valid, torque may not be controlled according to the torque slope and torque filter settings.

As torque control mode, there is a Profiles torque control (tq) and Cyclic synchronous torque control(cst).

For details, refer to Technical Reference, SX-DSV03307” Section 6-8”, EtherCAT communication specification.

The control mode is switched forcibly inside the driver depending on its operating status irrespective of the command from the host device. This operation has an effect on input signal processing.

[Conditions that the control mode is switched forcibly inside the driver]

- When frequency characteristic is measured by Setup support software.
(Position loop characteristics is position control, the speed closed loop characteristic and torque speed (vertical) are speed control, torque speed (normal) is torque control.)
- Test run of the setup support software (Forcibly position control mode).
- The states that are written "Forcibly controls the position" in "Deceleration stop sequence" (Section 6-3).
- “Retracting operation” in operation (Forcibly controls the position)

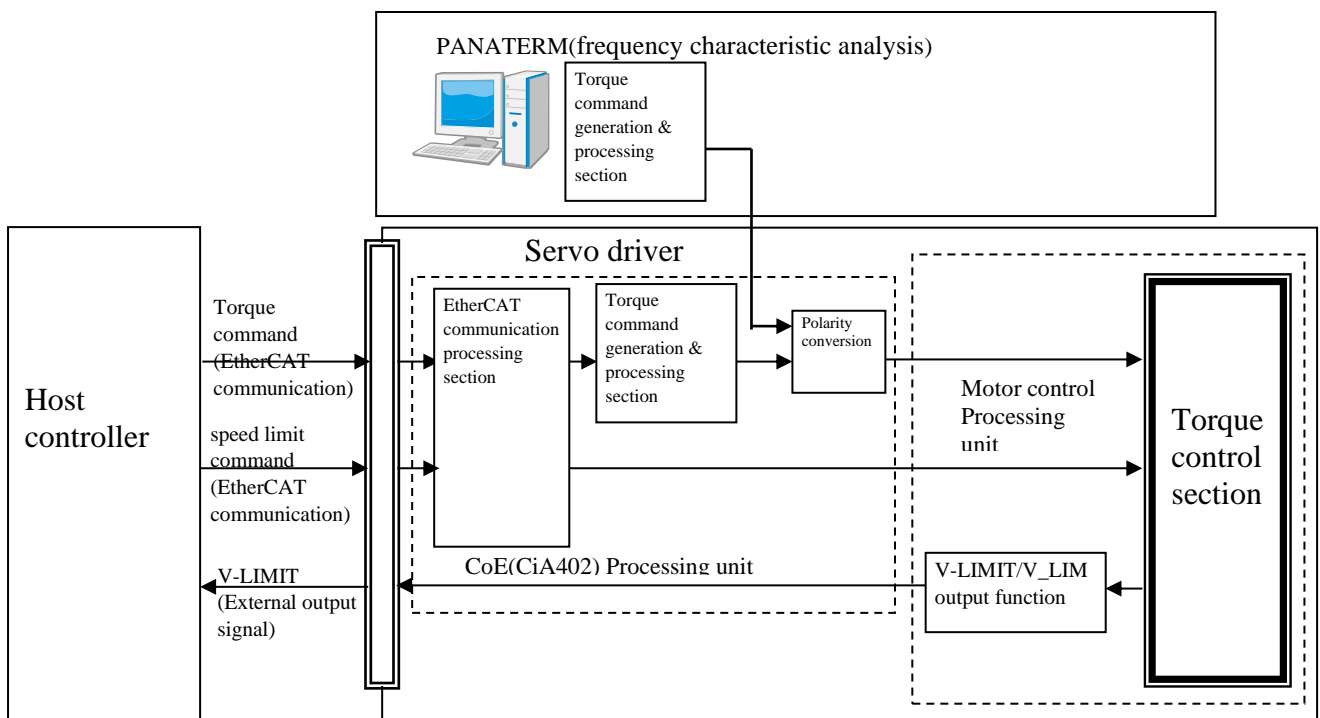

4-4-1 Speed limit function

The speed limit is one of protective functions used during torque control.

This function regulates the motor speed so that it does not exceed the speed limit while the torque is controlled.

Note: While the speed limit is used to control the motor, the torque command applied to the motor is not directly proportional to the torque command from host controller.

The torque command applied to the motor becomes the torque that the speed-controlled so that the motor speed becomes the speed limit value.

Note: If the motor runs in the direction opposite to the one specified by the torque command given by the host controller due to disturbance including gravity, the speed will not be within the limit.

If this matters, set the speed at which the motor needs to be stopped in Pr5.13 (over-speed level setting) or Pr6.15 (2nd over-speed protection level setting), so that Err26.0 (over-speed protection) or Err26.1 (2nd over-speed protection) is caused to happen in order to stop the motor.

For details on over-speed protection, refer to the section 6-3-5.

■ Relevant parameters

Class	No.	At-tribute *1)	Title	Range	Unit	Function				
3	17	B	Speed limit select	2	—	Set up the selection method of the speed limit used for torque control mode. <table border="1" data-bbox="826 770 1453 831"> <thead> <tr> <th>Setting value</th> <th>Speed limit value</th> </tr> </thead> <tbody> <tr> <td>2</td> <td>6080h (Max motor speed)</td> </tr> </tbody> </table> With this amplifier, it becomes 2 fixation.	Setting value	Speed limit value	2	6080h (Max motor speed)
Setting value	Speed limit value									
2	6080h (Max motor speed)									
6	97	B	Function expansion setting 3	-2147483648 ~ 2147483647	—	bit12 : Velocity limit priority function during torque control 0 : Torque command priority 1 : Velocity limit priority *2)*3)				

*1) For parameter attribute, refer to Section 9-1.

*2) It is enabled only for control mode cst.

*3) If 606Ch (Velocity actual value) exceeds the velocity limit value (607Fh (Max profile velocity) or 6080h (Max motor speed)), torque limit by 60E0h (Positive torque limit value) and 60E1h (Negative torque limit value) is disabled and control is performed by generating necessary torque so that the velocity becomes lower than the limit velocity.

However, the maximum torque is 6072h (Max torque).

4-5 Setting regenerative resistor

Cannot be used with [V frame].

The table describes setup of regenerative resistor.

For details of regenerative resistor specification, refer to Standard specifications.

■ Relevant parameters

Class	No.	Attribute *1)	Title	Range	Unit	Function
0	16	C	External Regenerative resistor setup	0-3	—	With this parameter, you can select either to use the built-in regenerative resistor of the driver, or to separate this built-in regenerative resistor and externally install the regenerative resistor. 0: Use the built-in resistor and activate regenerative over-load protection. 1: Use the external resistor and activate regenerative over-load protection. 2: Use the external resistor but do not activate regenerative over-load protection. 3: Do not use regenerative resistor. (Do not use over-load protection.) ※Please do not change the shipment value setting with V frame.
0	17	C	Selection of load factor of external regenerative resistor	0-4	—	When selecting the external regenerative resistor (Pr 0.16 = 1, 2), select the computing method of load factor of regenerative resistor. 0: Regenerative load factor is 100% when duty factor of external regenerative resistor is 10%. (Compatible with A4N series) 1-4: For manufacturer's use (do not setup) ※Please do not change the shipment value setting with V frame.

*1) For parameter attribute, refer to Section 9-1.

4-6 Absolute setup

4-6-1 Feedback scale

With the absolute type of feedback scale, an absolute system that does not require return to origin action after power-up, can be configured.

■ Relevant parameters

Class	No.	Attribute *1)	Title	Range	Unit	Function
3	23	R	Feedback scale selection	0-6	—	Set the feedback scale type. 0: AB phase output type 1: Serial communication type (incremental specification) 2: Serial communication type (absolute linear specification) 3: For manufacturer use 4: For manufacturer use 5: For manufacturer use 6: Serial communication type (absolute rotary specification)

*1) For parameter attribute, refer to Section 9-1.

4-6-1-1 Structure of absolute system

Absolute system configuration using EtherCAT communication interface
(Example: with servo driver single-axis connection)

In the EtherCAT communication response (driver → host controller), the absolute data is transferred to the host controller as the current position data.

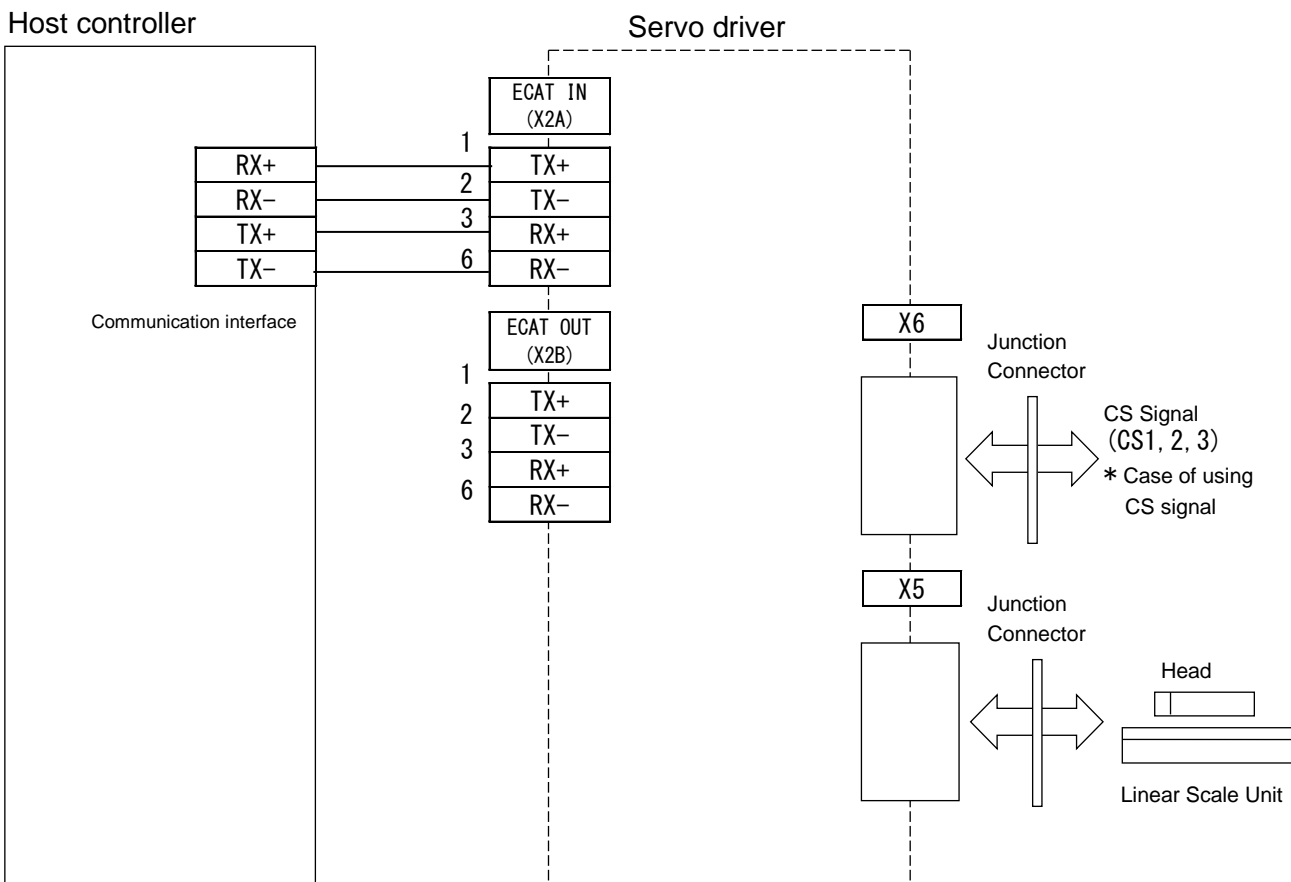

4-7 Linear motor/feedback scale setting

MINAS-A6BL series requires you to set up the linear motor/feedback scale to be connected.

Follow the procedures below to set up the linear motor/feedback scale.

■Procedures

1. Set up linear motor/feedback scale parameter		
(1) Linear motor (motor type, mass, rated torque, etc.) Feedback scale (resolution, etc.)	Linear type	4-7-1-1
	Rotary type	4-7-1-2
	Linear (VCM)	4-7-1-3
(2) Feedback scale	A/B phase output type	4-7-1-4
	Serial communication type (incremental specification)	
	Serial communication type (absolute linear specification)	
	Serial communication type (absolute rotary specification)	
(3) Pole position estimation	CS signal	4-7-3-1
	Pole position estimation	4-7-3-2
	pole position recovery	4-7-3-3

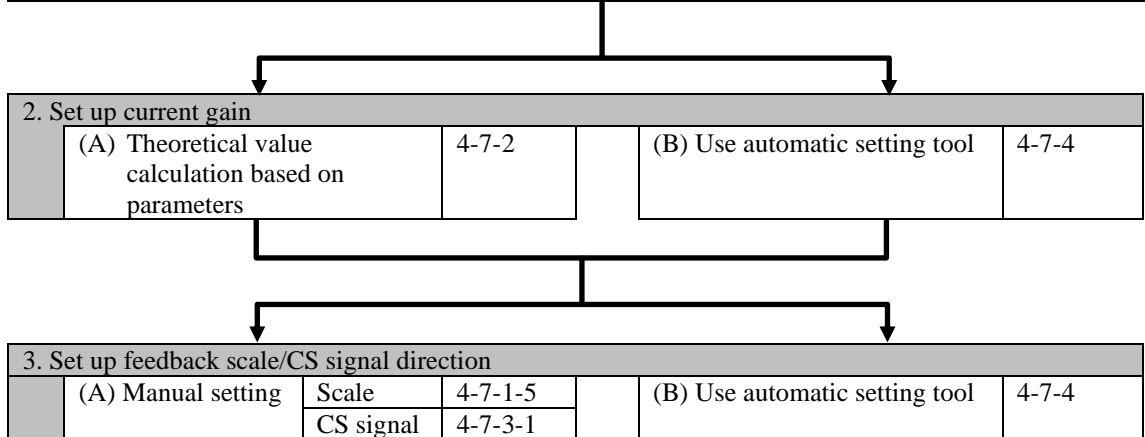

■Caution

- When the power is turned on at factory defaults, Err60.0 “Motor setting error protection” occurs. This is because the linear motor/feedback scale is not yet set up.
- When the installation condition is changed, such as when a linear motor or feedback scale is exchanged, follow the procedures above to configure the setting again.

4-7-1 Parameter setting according to linear motor/feedback scale specification

Set up various parameters by referring to the specifications of the linear motor to be connected.
Three motor types, which are “linear,” “rotary,” and “linear (VCM),” are supported.

Even with the same parameter number, the parameter has different functioning depending on whether the type is “linear,” “rotary,” or “linear (VCM).”

For details, see the parameter tables in 4-7-1-1, 4-7-1-2 and 4-7-1-3.

■Caution

- For Pr9.06 (Rated effective motor current), if a value exceeding the rated motor current is set, the current obtained when the thrust command is 100% will not take effect as the rated motor current. Therefore, Err16.0 (Overload protection) does not function normally, resulting in the risk of motor burnout.
- For Pr9.07 (Maximum instantaneous motor current), if a value exceeding the maximum instantaneous motor current is set, the current obtained when the maximum thrust command is given will not take effect as the motor maximum current. Therefore, Err16.1 (Thrust saturation error protection) does not function normally, resulting in the risk of motor burnout.

4-7-1-1 Linear type motor

■Relevant parameters: Linear type

Class	No.	Attribute *1)	Title	Setting range	Unit	Function
9	00	R	Motor type	0-3	—	Select the type of the motor to be connected. 1: Linear type, 2: Rotary type, 3: Linear (VCM) If the setting value is zero, Err60.0 “Motor setting error protection” occurs.
9	01	R	Feedback scale resolution	0-536870912	nm	Set the feedback scale resolution. The valid range is 1 to 1000000. If out of range, Err60.0 “Motor setting error protection” occurs
9	04	R	Motor movable part mass	0-32767	0.01 kg	Set the movable part mass of the motor. If the setting value is zero, Err60.0 “Motor setting error protection” occurs.
9	05	R	Motor rated thrust	0-32767	0.1 N	Set the rated thrust of the motor. If the setting value is zero, Err60.0 “Motor setting error protection” occurs.
9	06	R	Motor rated effective current	0-32767	0.1 Arms	Set the rated current of the motor. If the setting value is zero, Err60.0 “Motor setting error protection” occurs. Also, if it exceeds allowable rated current of the driver, Err60.1 “Motor combination error 1” occurs.
9	07	R	Motor maximum instantaneous current	0-32767	0.1 A	Set the maximum instantaneous current of the motor. If the setting value is zero, Err60.0 “Motor setting error protection” occurs. Also, if it exceeds maximum allowable instantaneous current of the driver, Err60.1 “Motor combination error 1” occurs.
9	10	R	Maximum overspeed level	0-20000	mm/s	Set the maximum overspeed of the motor. If the setting value is zero, Err60.0 “Motor setting error protection” occurs.
9	11	R	Carrier frequency	0-3	—	Select the carrier frequency. 0: 6 kHz, 1: 12 kHz, 2: 8 kHz, 3: For manufacturer’s use * The factory default of carrier frequency may vary according to frame size of the driver. * If the setting value is changed from the shipment value, a derating is necessary. For more information, refer to the Standard specifications.

(To be continued)

Class	No.	Attribute *1)	Title	Setting range	Unit	Function
9	02	R	Magnetic pole pitch	0-32767	0.01 mm	<p>Set the magnetic pole pitch. This setting value is valid only for Pr9.00 "Motor type selection" = 1 (linear type).</p> <p>This is not compatible with Pr9.30 "Number of pulses per magnetic pole". To set the magnetic pole with this parameter, set Pr9.30 "Number of pulses per magnetic pole" to zero.</p> <p>Err60.0 "Motor setting error protection" occurs in the cases below:</p> <ul style="list-style-type: none"> • Pr9.00 = 1 (linear type) and Pr9.02 = 0 and Pr9.30 < 512 • Pr9.00 = 1 (linear type) and Pr9.02≠0 and Pr9.30≠0
9	30	R	Number of pulses per magnetic pole	0-327670000	pulse	<p>Set the magnetic pole for the linear motor with the number of pulses. This value is valid only for Pr9.00 "Motor type selection" = 1 (linear type).</p> <p>Setting value = 512 or more: The value is the number of pulses per magnetic pole.</p> <ul style="list-style-type: none"> • The setting value becomes effective from 512. But, set it to not less than 2048 as much as possible. <p>Setting value = pole pitch [mm] ÷ scale resolution [um] x 1000</p> <p>This is not compatible with Pr9.02 "Magnetic pole pitch". To set the magnetic pole with this parameter, set Pr9.02 "Magnetic pole pitch" to zero.</p> <p>Err60.0 "Motor setting error protection" occurs in the cases below:</p> <ul style="list-style-type: none"> • Pr9.00 = 1 (linear type) and Pr9.02 = 0 and Pr9.30 < 512 • Pr9.00 = 1 (linear type) and Pr9.02≠0 and Pr9.30≠0 <p>Note: In general, use Pr9.02 "Magnetic pole pitch" for setting the magnetic pole. If this is the case, make sure to set this parameter to zero. Use this parameter only if Pr9.02 is exceptionally unavailable.</p>

*1) For information on the parameter attribute, refer to the section 9-1.

4-7-1-2 Rotary type motor

■Relevant parameter: Rotary type

Class	No.	Attribute *1)	Title	Setting range	Unit	Function
9	00	R	Motor type	0-3	—	Select the type of the motor to be connected. 1: Linear type , 2: Rotary type , 3: Linear (VCM) If the setting value is zero, Err60.0 “Motor setting error protection” occurs.
9	01	R	Number of scale pulses per revolution	0-536870912	pulse	Set the number of pulses of the feedback scale per revolution. The valid range is 10000 to 536870912. If out of range, Err60.0 “Motor setting error protection” occurs. Also, this value changes the supported speed [r/min]. If the number of pulses per second exceeds 1091 M[pulse/s] based on the Pr9.10 “Maximum overspeed level” value and this setting value, Err60.1 occurs. Example: Pr9.01 = 33554432 (25bit), Supported speed [r/min] = $60 \times 1091000000 / 33554432 = 1950.86$ So, if Pr9.10 is not less than 1951, Err60.1 occurs. Note:When using the serial communication type (absolute rotary specification) (Pr 3.23 = 6), be sure to set the value according to the scale specification. Otherwise, even if the ratio between the setting values of Pr9.01 and Pr9.03 is appropriate, normal control can not be performed. Regarding resolution of the serial communication type (absolute rotary specification), if it exceeds 2^{24} [pulse/r], only 2^n (2^{25} , 2^{26} , etc.) [pulse/r] are supported.
9	03	R	Number of pole pairs per rotation	0-255	Number of pole pairs	Set the number of pole pairs of the motor per revolution. If Pr9.00=2 (rotary type) and the setting value is zero, Err60.0 “Motor setting error protection” occurs.
9	04	R	Motor inertia	0-32767	0.00001 kgm ²	Set the inertia of the motor. If the setting value is zero, Err60.0 “Motor setting error protection” occurs.
9	05	R	Motor rated torque	0-32767	0.1 Nm	Set the rated torque of the motor. If the setting value is zero, Err60.0 “Motor setting error protection” occurs.
9	06	R	Motor rated effective current	0-32767	0.1 Arms	Set the rated current of the motor. If the setting value is zero, Err60.0 “Motor setting error protection” occurs. Also, if it exceeds allowable rated current of the driver, Err60.1 “Motor combination error 1” occurs.
9	07	R	Motor Maximum instantaneous current	0-32767	0.1 A	Set the maximum instantaneous current of the motor. If the setting value is zero, Err60.0 “Motor setting error protection” occurs. Also, if it exceeds maximum allowable instantaneous current of the driver, Err60.1 “Motor combination error 1” occurs.
9	10	R	Maximum overspeed level	0-20000	r/min	Set the maximum overspeed of the motor. If the setting value is zero, Err60.0 “Motor setting error protection” occurs. Also, this value changes the supported speed [r/min]. If the number of pulses per second exceeds 1091 M[pulse/s] based on the Pr9.01 “Number of scale pulses per revolution” value and this setting value, Err60.1 occurs.
9	11	R	Carrier frequency	0-3	—	Select the carrier frequency. 0: 6 kHz, 1: 12 kHz, 2: 8 kHz, 3: For manufacturer’s use * The factory default of carrier frequency may vary according to frame size of the driver. * If the setting value is changed from the shipment value, a derating is necessary. For more information, refer to the Standard specifications.

*1) For information on the parameter attribute, refer to the section 9-1.

4-7-1-3 Linear type motor

■Relevant parameters: Linear (VCM)

Class	No.	Attribute *1)	Title	Setting range	Unit	Function
9	00	R	Motor type	0-3	—	Select the type of the motor to be connected. 1: Linear type , 2: Rotary type, 3: Linear (VCM) If the setting value is zero, Err60.0 “Motor setting error protection” occurs.
9	01	R	Feedback scale resolution	0-536870912	nm	Set the feedback scale resolution. The valid range is 1 to 1000000. If out of range, Err60.0 “Motor setting error protection” occurs
9	04	R	Motor movable part mass	0-32767	0.01 kg	Set the movable part mass of the motor. If the setting value is zero, Err60.0 “Motor setting error protection” occurs.
9	05	R	Motor rated thrust	0-32767	0.1 N	Set the rated thrust of the motor. If the setting value is zero, Err60.0 “Motor setting error protection” occurs.
9	06	R	Motor rated effective current	0-32767	0.1 A	Set the rated current of the motor. If the setting value is zero, Err60.0 “Motor setting error protection” occurs. Also, if it exceeds allowable rated current of the driver, Err60.1 “Motor combination error 1” occurs.
9	07	R	Motor maximum instantaneous current	0-32767	0.1 A	Set the maximum instantaneous current of the motor. If the setting value is zero, Err60.0 “Motor setting error protection” occurs. Also, if it exceeds maximum allowable instantaneous current of the driver, Err60.1 “Motor combination error 1” occurs.
9	10	R	Maximum overspeed level	0-20000	mm/s	Set the maximum overspeed of the motor. If the setting value is zero, Err60.0 “Motor setting error protection” occurs.
9	11	R	Carrier frequency	0-3	—	Select the carrier frequency. 0: 6 kHz, 1: 12 kHz, 2: 8 kHz, 3: For manufacturer’s use * The factory default of carrier frequency may vary according to frame size of the driver. * If the setting value is changed from the shipment value, a derating is necessary. For more information, refer to the Standard specifications.

*1) For information on the parameter attribute, refer to the section 9-1.

4-7-1-4 Feedback scale type setting

Select the type of the feedback scale to be used.

■Relevant parameters

Class	No.	Attribute *1)	Title	Setting range	Unit	Function
3	23	R	Feedback scale selection	0-6	—	<p>Set the feedback scale type.</p> <p>0: AB phase output type 1: Serial communication type (increment specification) 2: Serial communication type (absolute linear specification) 3: For manufacturer use 4: For manufacturer use 5: For manufacturer use 6: Serial communication type (absolute rotary specification)</p> <p>In the case where the type of the connected feedback scale does not agree with the setting, the following error may occur depending on the situation. Err50.0 “Feedback scale wiring error protection” Errs55.0 to 2 “A/B/Z phase wiring error protection” Err93.3 “Feedback scale connection error”</p>

*1) For information on the parameter attribute, refer to the section 9-1.

Pr3.23	Feedback scale type	Acceptable speed *2
0	AB phase output type *1	Up to 4 M [pulse/s] (multiplied by 4)
1	Serial communication type (increment specification)*4	Linear type : Up to 4000 M [pulse/s]*5 Linear (VCM) : Up to 4000 M [pulse/s] Rotary type : Up to 1000 M [pulse/s]
2	Serial communication type (absolute linear specification) *4	Up to 4000 M [pulse/s]*5
6	Serial communication type (absolute rotary specification) *3 *4	Up to 1000 M [pulse/s]

*1 The table below lists the count direction of feedback scale for the A/B phase output type in the internal driver process.

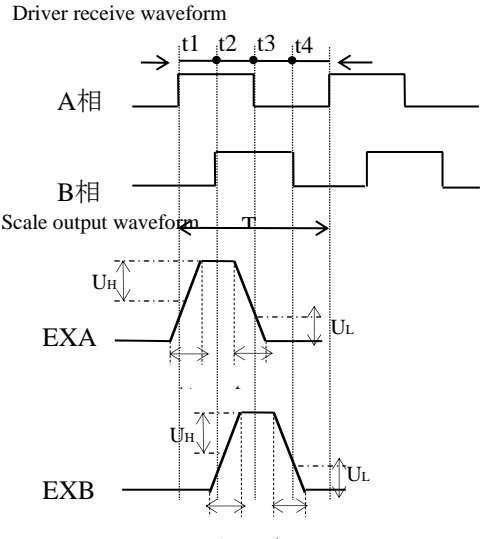
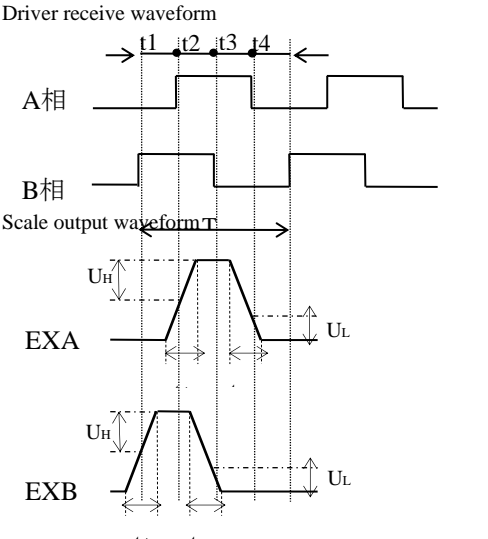
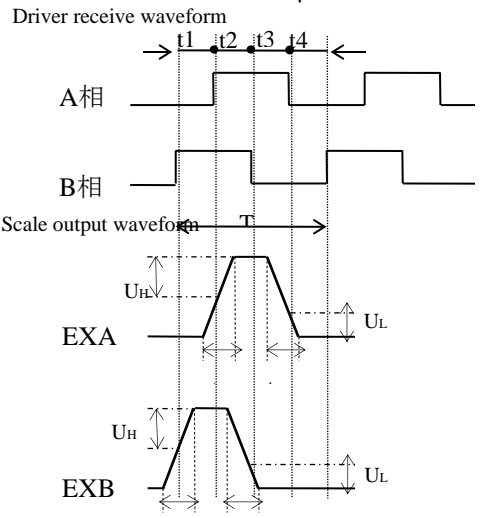
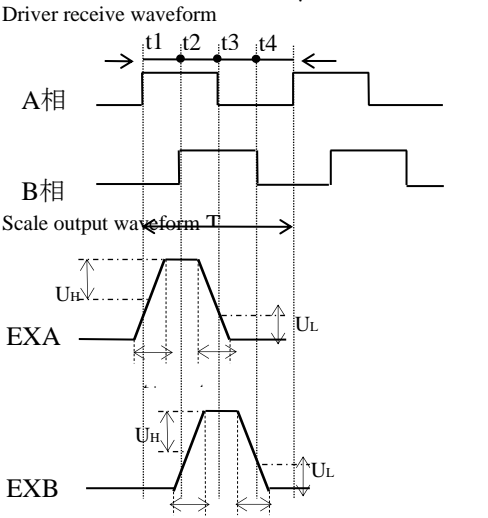
Pr3.26	Negative direction (count down)	Positive direction (count up)
0,2: not reversed	<p>A-phase is by 90° ahead of B-phase $t_1 t_2 t_3 t_4 > 0.25\mu\text{s}$ $T > 1.0\mu\text{s}$</p> <p>Driver receive waveform</p> 	<p>B-phase is by 90° ahead of A-phase $t_1 t_2 t_3 t_4 > 0.25\mu\text{s}$ $T > 1.0\mu\text{s}$</p> <p>Driver receive waveform</p> 
1,3 : reversed	<p>B-phase is by 90° ahead of A-phase $t_1 t_2 t_3 t_4 > 0.25\mu\text{s}$ $T > 1.0\mu\text{s}$</p> <p>Driver receive waveform</p> 	<p>A-phase is by 90° ahead of B-phase $t_1 t_2 t_3 t_4 > 0.25\mu\text{s}$ $T > 1.0\mu\text{s}$</p> <p>Driver receive waveform</p> 

*2 The acceptable speed represents the feedback speed [pulse/s] of the feedback scale to be processed by driver.

For the supported range in the scale side, refer to the scale specifications.

For example, when using the feedback scale at 1 nm resolution in the serial communication type, the speed is up to 4 m/s. Also, to use the serial communication type at 8 m/s speed, select 2 nm or more for the feedback scale resolution.

*3 Only in case of setting the rotary type, the setting of Pr3.23 = 6 is enabled.

*4 The serial incremental feedback scale is usable with Pr3.23 = 1 for both linear and rotary types. The absolute scale will cause Err 93.3 “Feedback scale connection error” unless the setting is appropriate for the linear or rotary type.

*5 It is supported up to 2000 M [pulse/s] during speed/torque control.

4-7-1-5 Manual direction setting of feedback scale

■Relevant parameters

Class	No.	Attribute *1)	Title	Setting range	Unit	Function
3	26	R	Feedback scale and CS direction inversion	0-3	—	Set the reversal of the feedback counter and CS signal direction of the feedback scale. [Scale] [CS signal] 0 not reversed not reversed 1 reversed not reversed 2 not reversed reversed 3 reversed reversed The logic setting of CS signal is valid only when the CS signal is selected (Pr9.20 = 1). For VCM, the logic setting of the CS signal is disabled.

*1) For information on the parameter attribute, refer to the section 9-1.

• Other than VCM

Set up these parameters so that the relationship between the feedback scale count direction and motor's inductive voltage phase order meets the diagram below. Check the count direction of the feedback scale by using the PANATERM (sum of scale pluses) while removing the motor cables and moving the movable part by hand.

Note: Before checking the count direction, make sure to set 607Eh "Polarity" to 0 and write the data in EEPROM and turn OFF and ON the power supply.

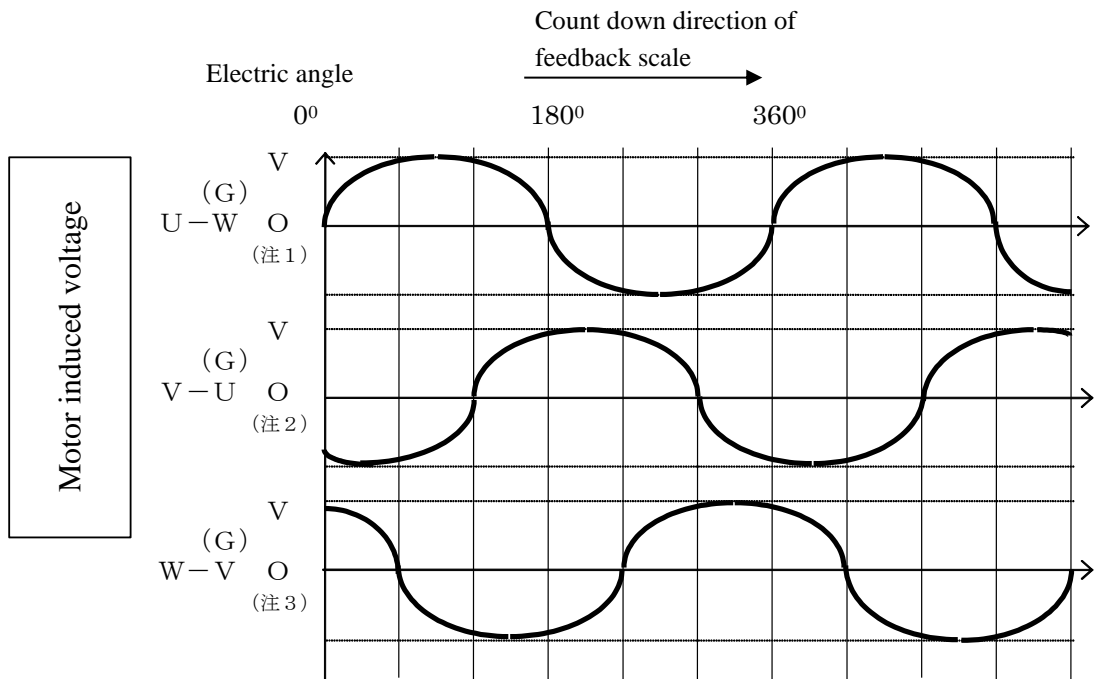

Note 1: It is a waveform generated when checking the induced voltage in the terminal U by connecting the terminal W with GND.

Note 2: It is a waveform generated when checking the induced voltage in the terminal V by connecting the terminal U with GND.

Note 3: It is a waveform generated when checking the induced voltage in the terminal W by connecting the terminal V with GND.

• For VCM

When using VCM, connect the U and W terminals of the amplifier, and never connect the V terminal.

4-7-2 Current gain setting

There are two ways to set the current gain: theoretical value calculation (when the motor phase inductance and resistance are known) with parameters and automatic setting with a tool.

This section describes how to calculate the theoretical value with parameters.

For information on the automatic setting with a tool, refer to “Section 4-7-4”

■Relevant parameters

Class	No.	Attribute *1)	Title	Setting range	Unit	Function
9	08	R	Phase inductance	0-32767	0.01 mH	Set the phase inductance of the motor. If Pr9.12 “Automatic current response adjustment” ≠ 0 and this value is zero, Err60.0 “Motor setting error protection” occurs.
9	09	R	Phase resistance	0-32767	0.01 Ω	Set the phase resistance of the motor. If Pr9.12 “Automatic current response adjustment” ≠ 0 and this value is zero, Err60.0 “Motor setting error protection” occurs.
9	12	R	Automatic current response adjustment	0-100	%	When this value ≠ 0, calculate the theoretical values of Pr9.13 and Pr9.14 from Pr9.08 and Pr9.09. Set the standard for current responsivity when calculating Pr9.13 “Proportional current gain” and Pr9.14 “Integral current gain”. The bigger the setting value is, the higher the current response is. But, because it can cause unusual behaviors including oscillation, set an appropriate value according to the operational state. Roughly speaking, if Pr9.11 = 0 (carrier 6 kHz), set 40. If Pr9.11 = 1 (carrier 12 kHz), set 80. If Pr9.11 = 2 (carrier 8kHz), set 55. If the setting value is zero, the theoretical values of Pr9.13 and Pr9.14 is not calculated. Otherwise, set Pr9.13 and Pr9.14 manually or automatically with a tool. *The setting value is made invalid when 3 “Linear (VCM)” is set for Pr9.00 “Motor type select.”
9	13	B	Proportional current gain	0-32767	—	Set a proportional current gain. In general, use the theoretical value as is calculated using Pr9.12.
9	14	B	Integral current gain	0-32767	—	Set an integral current gain. In general, use the theoretical value as is calculated using Pr9.12.
9	48	B	Voltage feed forward gain 1	0-32767	—	Set a voltage feed forward gain 1. The higher the setting, the higher the current response to the change in torque command becomes. However, since it may cause oscillation or any other faulty operation, select an appropriate value according to the operating conditions. There is no compatibility with the automatic setting by the use of Pr9.12.
9	49	B	Voltage feed forward gain 2	0-32767	—	Set a voltage feed forward gain 2. The higher the setting, the higher the current response to torque command. However, since it may cause oscillation or any other faulty operation, select an appropriate value according to the operating conditions. There is no compatibility with the automatic setting by the use of Pr9.12.

*1) For information on the parameter attribute, refer to the section 9-1.

*2) The value is calculated at power-on.

■Cautions

- Our servo amplifiers are made specifically for the connection with a motor that uses Y connection.
If a motor for Δ connection is used, calculate the settings of Pr9.08 (Motor phase inductance) and Pr9.09 (Motor phase resistance) from the formula shown below.

$$l = \frac{1}{3}L \qquad r = \frac{1}{3}R$$

L: Inductance between lines in Δ connection

R: Resistance between lines in Δ connection

l: Phase inductance in Y connection

r: Phase resistance in Y connection

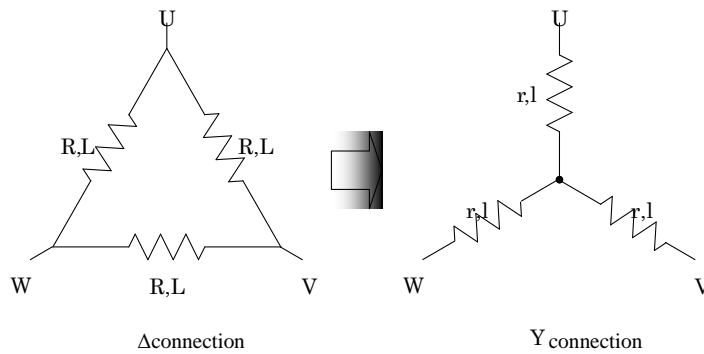

- If the setting of Pr9.12 (Automatic current response adjustment) is other than 0, the theoretical values of Pr9.13 (Proportional current gain) and Pr9.14 (Integral current gain) are calculated from the settings of Pr9.08, Pr9.09, and Pr9.12. Therefore, note that if a wrong setting is entered for Pr9.08 and/or Pr9.09, correct theoretical values cannot be obtained and current response will be affected.

4-7-3 Pole position detection method setting

There are three ways to detect the motor's pole position: CS signal-using method (CS signal), automatic estimation method of pole position without using CS signal (Pole position estimation), and stored position-using method (Pole position recovery).

In addition, magnetic position detection is not performed in the case of linear type (VCM).

4-7-3-1 CS signal method

Detect a pole position by using the CS signals (CS1, CS2, CS3).

This section describes how to manually set the direction and phase of CS signal.

For information on the automatic setting with a tool, refer to the "Section 4-7-4".

■Relevant parameters

Class	No.	Attribute *1)	Title	Setting range	Unit	Function
9	20	R	Pole detection method	0-3	—	Set how to detect a pole position. 1: CS signal 2: Pole position estimation 3: Pole position recovery If the setting value is zero, Err60.0 "Motor setting error protection" occurs. The setting value is made invalid when a value other than 0 is set and 3 "Linear (VCM)" is set for Pr9.00 "Motor type select."
9	21	R	CS phase	0-360	Electric angle (°)	Set up the phase difference between the induced voltage of the motor and CS signal. This setting is valid only when CS signal is selected (Pr9.20 = 1).
3	26	R	Feedback scale & CS reversal	0-3	—	Set the reversal of the feedback counter and CS signal direction of the feedback scale. [Scale] [CS signal] 0 not reversed not reversed 1 reversed not reversed 2 not reversed reversed 3 reversed reversed The logic setting of CS signal is valid only when the CS signal is selected (Pr9.20 = 1). For VCM, the logic setting of the CS signal is disabled.

*1) For information on the parameter attribute, refer to the section 9-1.

Connect the terminals so that the relationship between the motor's induced voltage and CS1, 2, 3 signals can meet the figure below.

Note that Pr9.21 "CS phase" enables to correct a relative phase. (See subsequent page)

Also, Pr3.26 enables to set the CS signal direction. (See the CS signal direction described later)

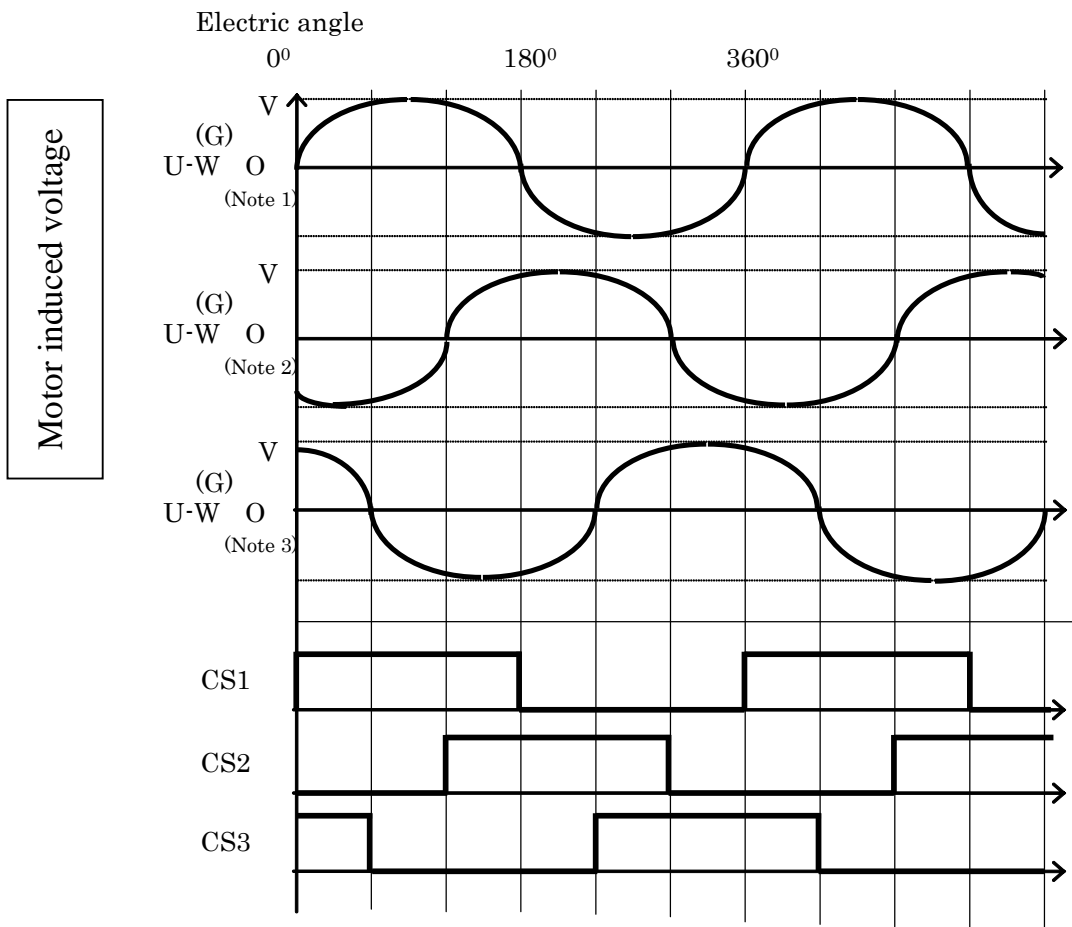

Note 1: It is a waveform generated when checking the induced voltage in the terminal U by connecting the terminal W with GND.

Note 2: It is a waveform generated when checking the induced voltage in the terminal V by connecting the terminal U with GND.

Note 3: It is a waveform generated when checking the induced voltage in the terminal W by connecting the terminal V with GND.

- How to set relative phase using Pr9.21 “CS phase”

If it is difficult to connect the terminals in the same way as shown in previous page, Pr9.21 “CS phase” enables to compensate the relative phase with the software.

For example, if the relationship between the induced voltage and CS signal is the same as shown in the figure below in the count down direction of the feedback scale, the rising edge misalignment is 60° between the induced voltage of the terminals U-W and the CS1 signal. So, set Pr9.21 to ‘60’.

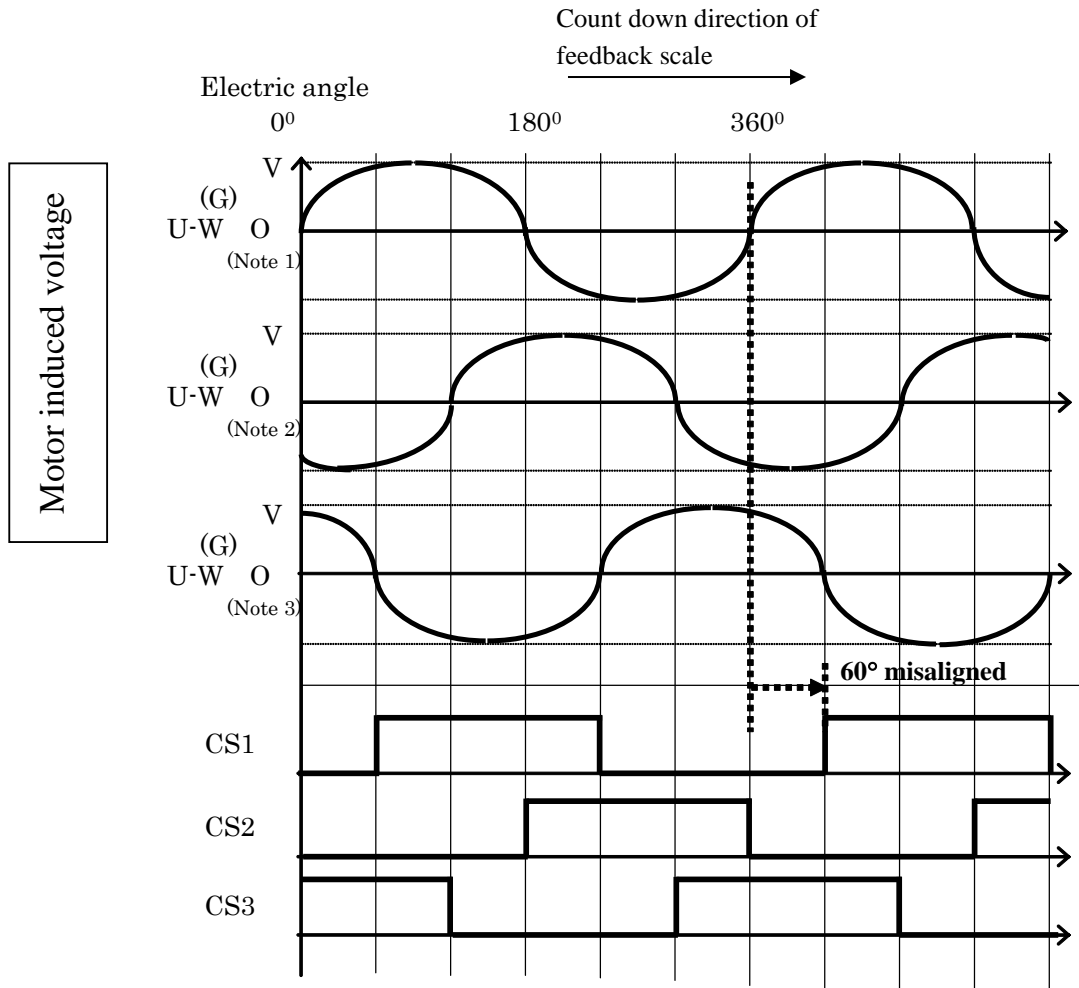

Note 1: It is a waveform generated when checking the induced voltage in the terminal U by connecting the terminal W with GND.

Note 2: It is a waveform generated when checking the induced voltage in the terminal V by connecting the terminal U with GND.

Note 3: It is a waveform generated when checking the induced voltage in the terminal W by connecting the terminal V with GND.

· How to set the CS signal direction by using Pr3.26 “Feedback scale & CS reversal”

There are two types of wiring patterns among CS1, CS2, and CS3 as shown in the figure below. In the figure above, the wiring among CS1, CS2, and CS3 is correct for the induced voltage, so set the CS signal direction to “not reversed” using Pr3.26.

On the contrary, in the figure below, the wiring between CS2 and CS3 is the reverse of the figure above, so set the CS signal direction to “reversed” by using Pr3.26.

The “reversed” CS direction exchanges CS2 and CS3 on the inside of the servo driver, so the motor works properly.

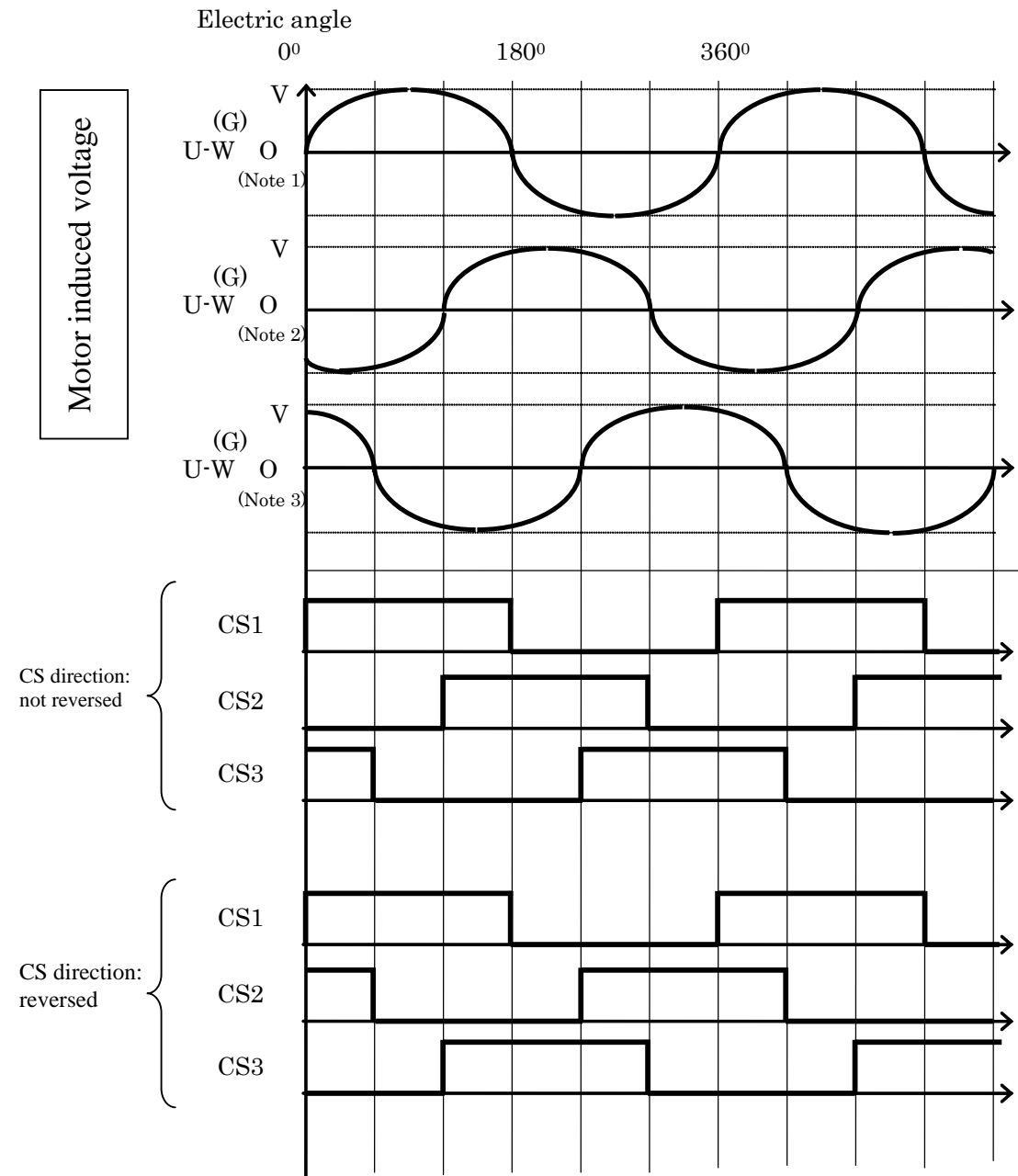

- Note 1: It is a waveform generated when checking the induced voltage in the terminal U by connecting the terminal W with GND.
- Note 2: It is a waveform generated when checking the induced voltage in the terminal V by connecting the terminal U with GND.
- Note 3: It is a waveform generated when checking the induced voltage in the terminal W by connecting the terminal V with GND.

4-7-3-2 Pole position estimation method

The pole position is automatically estimated at the first servo-on after power-on without using the CS signal. The pole position estimated is valid until the power supply is reset. After the power reset, the pole position is automatically estimated again at the first servo-on.

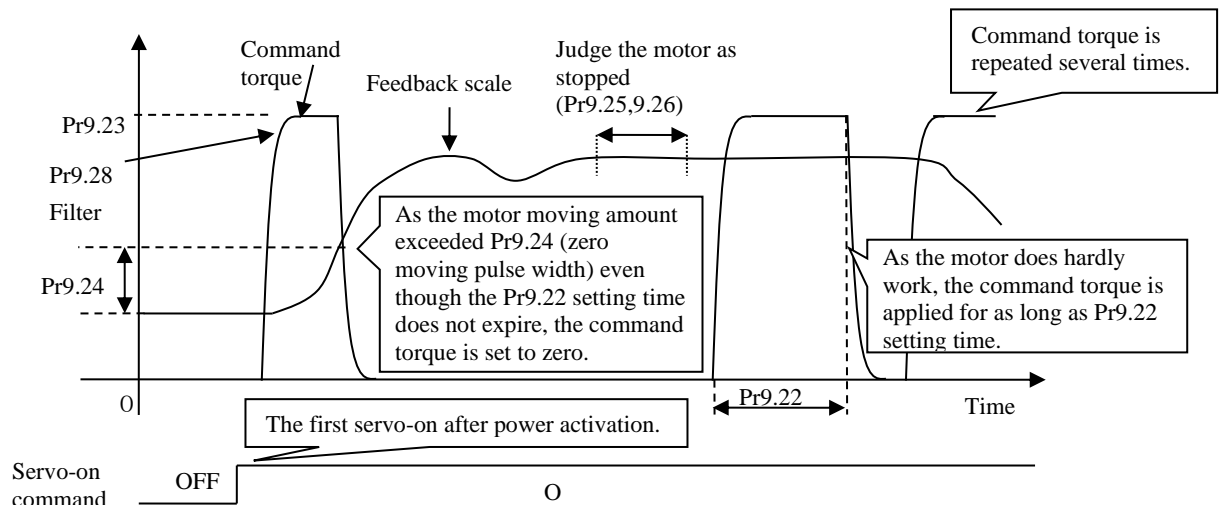

■Relevant parameters

Class	No.	Attribute *1)	Title	Setting range	Unit	Function
9	20	R	Pole detection method	0-3	—	Set how to detect a pole position. 1: CS signal 2: Pole position estimation 3: Pole position recovery If the setting value is zero, Err60.0 "Motor setting error protection" occurs. The setting value is made invalid when a value other than 0 is set and 3 "Linear (VCM)" is set for Pr9.00 "Motor type select."
9	22	B	Torque command time for estimating pole position	0-200	ms	<ul style="list-style-type: none"> Set the time to apply a command when estimating pole position. When the moving pulse count of the motor goes over Pr9.24 setting value, the torque command stops even if the time does not expire. If the setting value is small, the motor will not work adequately, resulting in a bad estimation accuracy or pole position estimation error. This setting is valid only when the pole position estimation is selected (Pr9.20=2). Note: The actual time is about the setting value plus 4 ms
9	23	B	Command torque for estimating pole position	0-300	%	<ul style="list-style-type: none"> Set the torque per command when estimating pole position. If the setting value is small, the motor will not work adequately, resulting in a bad estimation accuracy or pole position estimation error. This setting is valid only when the pole position estimation is selected (Pr9.20 = 2). Note: The actual command torque is limited by the maximum allowable torque of the motor.
9	24	B	Zero moving pulse width for estimating pole position	0-32767	pulse	<ul style="list-style-type: none"> Set the pulse width for judging as a zero moving in the pole position estimation. When the motor moving pulse is less than this setting value regardless of the torque application under the Pr9.22 and Pr9.23 conditions, it is judged as a zero travel. The travel amount can be reduced in the pole position estimation by reducing the setting value, but the estimated accuracy may be poor. Roughly speaking, set the number of pulses corresponding to the electric angle. This setting is valid only when the pole position estimation is selected (Pr9.20 = 2).

(To be continued)

Class	No.	Attribute *1)	Title	Setting range	Unit	Function
9	25	B	Stop pulse count for estimating pole position	0-32767	pulse	• Set the condition for judging the motor as stopped in the pole position estimation. • When the motor moving pulse count is not more than Pr9.25 for Pr9.26 [ms] at 2 ms interval, the motor is judged as stopped and next torque command is applied.
9	26	B	Stop time for estimating pole position	0-32767	ms	• This setting is valid only when the pole position estimation is selected (Pr9.20 = 2).
9	27	B	Stop time limit for estimating pole position	0-32767	ms	• Set the time limit for judging the motor as stopped in the pole position estimation. • If the motor is not judged as stopped even if this setting time expires, Err61.1 Pole position estimation error 2 occurs. • This setting is valid only when the pole position estimation is selected (Pr9.20=2).
9	28	B	Torque command filter for estimating pole position	0-2500	0.01 ms	• Set the time constant of the filter for the torque command in the pole position estimation. If the setting value is zero, the filter will be invalid and only a step command will be available. • This setting is valid only while estimating the pole position when the pole position estimation is selected (Pr9.20=2).

*1) For information on the parameter attribute, refer to the section 9-1.

■Cautions

- This function is done at the first servo-on after power-on. The motor works when estimating the pole position, the operation commands are generated on the inside of the servo driver regardless of the operation commands (including control mode) from upper equipment, so fully take care so as not to collide with the end of the unit.
- This function may not work as expected when the vertical axis, uneven load, or friction is large Use of CS signal method (4-7-3-1) is recommended in such a case.
- The setting values for Prs9.22 to 9.27 are valid set during the startup of the pole position estimation. The change is ignored while estimating the pole position.
- For the estimated accuracy when estimating the pole position, check the segment 7 LED (Pr7.00=8) in the front panel or PANATERM's status monitor. The smaller this numeric value is, the better the accuracy is. This accuracy is an estimated accuracy based on the pole position estimation method and will not warrant a real accuracy. Use it only for reference.
- When magnet pole position estimation is used, the system will not shift to Operation enabled (servo ON) until magnet pole position estimation is completed.
- When multiple axes lock the same work as shown in the figure below:

Do not run the pole position estimation (at the first servo-on after power-on) in the multiple axes at the same time.

As synchronous operation is not available while estimating the pole position, the pole position estimation cannot be finished properly because the axes may suffer an impact from other axis, the estimation result finished might have a large error, or **the unit may be damaged.**

Be sure that the axes excluded from the pole position estimation cannot give any impact on the axis to be estimated.

In this configuration, we recommend you to use the CS signal method (4-7-3-1) or Pole position recovery (4-7-3-3).

To use the pole position recovery method, apply the pole position estimation to each linear motor alone.

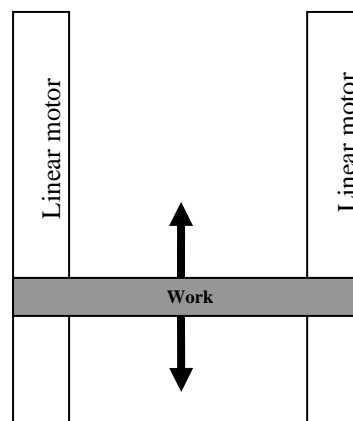

- Since the operation command from the host device becomes valid during csp control at the timing when magnet pole position estimation is completed, it may suddenly move to the command position and cause vibration if the difference between the stop position at completion of magnet pole position estimation and the command position is large.
It is therefore necessary to take the following measure for the entire system, including the processing of the host device.

(Measure) Have the command position tracked during magnet position estimation.

4-7-3-3 Pole position recovery method

Once a pole position is estimated with the pole position estimation method (4-7-3-2), the pole position can be stored and the motor can be controlled by using the pole position even after the power reset.
This recovery method can be supported only when the feedback scale of absolute type is used.

■Relevant parameters

Class	No.	Attribute *1)	Title	Setting range	Unit	Function
9	20	R	Pole detection method	0-3	—	Set up the magnet pole position detection method. 1: CS signal 2: Pole position estimation 3: Pole position recovery If the setting value is zero, Err60.0 “Motor setting error protection” occurs. The setting value is made invalid when a value other than 0 is set and 3 “Linear (VCM)” is set for Pr9.00 “Motor type select.”

*1) For information on the parameter attribute, refer to the section 9-1.

■Procedures 1 (normal operation)

- (1) Restart the control power supply after setting to Pr9.20=2 and writing it into EEPROM.
- (2) Execute magnet pole position estimation (refer to 4-7-3-2).
- (3) Restart the control power supply after changing to Pr9.20=3 and writing it into EEPROM.

* After this process, the magnet pole position estimation result from execution in (2) is restored at control power supply restart.

■Procedures 2 (at amplifier replacement)

It is possible to restore the magnet pole estimation result for a different amplifier by following the procedures below to execute setup.

- (1) Connect with the amplifier to be the source of magnet pole position estimation result copying via PANATERM, and save the parameter information for the source amplifier.
- (2) Connect with the amplifier to copy the magnet pole position estimation result via PANATERM.
- (3) Select “Copy magnet pole position estimation result” from “Other” menu on PANATERM.
- (4) Select “Load” to load the parameter information saved in (1).
- (5) Select “Execute” and write the magnet pole position estimation result into the subject amplifier.
- (6) Restart the control power supply after setting to Pr9.20=3 and writing it into EEPROM.

■Cautions

- In Procedures 1, The estimation result of the pole position is stored in the driver. When the combination of the driver and linear motor is changed (exchange of driver, linear motor, or feedback scale), the pole position may change, thereby disabling you to control the motor properly.
In this case, because the driver cannot recognize the change, an alarm will not occur.
When one of components above is exchanged at least, set Pr9.20=2 once. Then, estimate the poles position again and set Pr9.20=3.
- Procedures 2 is for the case when the linear motor and the feedback scale are not exchanged but the amplifier alone is exchanged. When exchanging the linear motor and the feedback scale, because the pole position changes, an incorrect estimation result of pole position will be written in the amplifier and it inhibits normal motor control. When changing the motor, estimate the pole position again before use.
- When this method is selected while the pole position is not estimated at all or while the estimation result of the pole position is cleared, Err61.2 “Magnetic pole position estimation error 3” occurs.
- The estimation result of the pole position is cleared when the detection method of pole position is not specified (Pr9.20=0).
However, EEPROM relevant alarms (Errs36.0 - 2, Errs37.0 - 2) are not cleared. Also, any alarm is not cleared when Err11.0 “Control power undervoltage protection” occurred.
- When this method is selected while using the feedback scale of other than absolute type, Err61.2 “Pole position estimation error 3” occurs.

4-7-4 Automatic linear motor setting with tool

The initial parameter (current gain, feedback scale direction, CS direction) for the combination with a linear motor can be automatically set by using the automatic setting tool (MotorAutoSetup).

■ Parameter changed by the automatic linear motor setting

The automatic linear motor setting updates the parameters below:

Class	No.	Attribute *1)	Title	Setting range	Unit	Function
3	26	R	Feedback scale & CS reversal	0-3	—	Set the reversal of the feedback counter and CS signal direction of the feedback scale. [Scale] [CS signal] 0: not reversed not reversed 1: reversed not reversed 2: not reversed reversed 3: reversed reversed The logic setting of CS signal is valid only when the CS signal is selected (Pr9.20 = 1). For VCM, the logic setting of the CS signal is disabled.
9	13	B	Proportional current gain	0-32767	—	Set a proportional current gain.
9	14	B	Integral current gain	0-32767	—	Set an integral current gain.
9	21	R	CS phase	0-360	Electric angle (°)	Set the relative phase between the motor's induced voltage and CS signal. This setting is valid only when CS signal is selected (Pr9.20 = 1).

*1) For information on the parameter attribute, refer to the section 9-1.

- To set Pr9.13 “Proportional current gain” and Pr9.14 “Integral current gain” by using the automatic linear motor setting, set Pr9.12 “Automatic current response adjustment” to zero.

■ How to automatically set linear motor

For automatically setting a linear motor, the automatic setting tool (MotorAutoSetup) is required.
(For information on the automatic setting tool, contact us.)

[Linear motor automatic setting tool (MotorAutoSetup)]

MotorAutoSetup MINAS-A6 series : MADLT15NM

File Help

Step1 >> Step2 >> Step3 >> Finish

Set of the basic parameter Current loop auto tuning Scale direction / CS auto setup

Step1 : Set of the basic parameter

Pr9.00 Motor type selection: 1:Linear

Scale setup

Pr3.23 Feedback scale selection: 0:A,B phase output type

Pr9.01 Feedback scale resolution: 1,000 um

Linear motor setup

Pole pitch of 0.01mm ~ 327.67mm range.

Pr9.02 Magnetic pole pitch: 2.50 mm

Pr9.05 Rated motor thrust: 1.3 N

Pr9.06 Rated motor effective current: 1.7 Arms

Pr9.07 Maximum instantaneous motor current: 7.5 A

Pr9.30 = Magnetic pole pitch[mm] / Feedback scale resolution[mm]

Pr9.30 The number of pulses per magnetic pole: 0 pulse

Pr9.04 Weight of motor's movable section: 0.06 kg

Estimated at 312 % thrust limit.
(([Pr9.07] / 2^(1/2) / [Pr9.06]) * 100 %)

Others parameter setup

Pr0.13 1st thrust limit: 500 %

Pr9.10 Over speed level setup: 3000 mm/s

Pr9.20 Magnetic poles detection method selection: 2:Magnetic poles position estimation method

Pr6.15 2nd over speed level setup: 0 mm/s

Read Write Next

When the automatic setting starts, the linear motor works in order to automatically set up the linear motor after the servo-on. After the automatic setting is finished, the servo is automatically turned OFF.

After the automatic setting, make sure to reset the power supply of the servo driver finally.

(For information on how to use the linear motor automatic setting tool, refer to the tool's procedure manual.)

■Cautions

- The version of the tool compatible with A6NL series is 2.0.0.1 or later.
In the case of VCM type, the automatic setting tool (MotorAutoSetup series is 2.0.0.3 or later) is not available.
- In the linear motor automatic setting, the motor may move up to two cycles of electric angle.
Secure the movable range in advance before the automatic setting.
- This function may not work as expected when the vertical axis, uneven load, or friction is large.
Also, the tool may not work properly when a load is mounted. If this is the case, run the tool with the linear motor alone by unmounting the load.
- The tool may not work properly when the basic setting is not correct for the linear motor and scale. Set the data properly by referring to “4-7-1 Parameter setting according to linear motor/feedback scale specification” in advance.
- If the network is established with the upper controller while automatically setting the linear motor, Err60.3 “Linear motor automatic setting error protection” occurs and the tool is killed.
- If Pr9.20 “Pole detection method” = 2 (Pole position estimation), when the linear motor is automatically set while the pole position estimation was finished, the pole position estimation becomes unfinished. The pole position will be estimated on next servo-on.
- If the torque command is overshoot while automatically setting the linear motor, Err60.3 “Linear motor automatic setting error protection” occurs and the tool is killed.
- When the external servo-on signal is allocated for input signal allocation, turn ON the external servo-on signal. If the external servo-on signal remains OFF, the servo cannot turn ON and the automatic setting cannot start.
Also, if the external servo-on signal is turned OFF during the automatic setting, the servo turns OFF and the tool is killed.
- After the automatic setting is finished, make sure to reset the power supply of the servo driver and establish the network with the upper controller. If it is tried to establish network with the upper controller without resetting the power supply of the servo driver, Err60.3 “Linear motor automatic setting error protection” occurs.
- Pr9.48 “Voltage feed forward gain 1” and Pr9.49 “Voltage feed forward gain 2” are not compatible with the automatic setup of the current gain. Any execution of the automatic setup will result in a setting of zero (0).

5. Gain tuning/vibration suppressing function

5-1 Automatic adjusting function

The figure below shows outline of automatic adjusting function of MINAS-A6BL series.

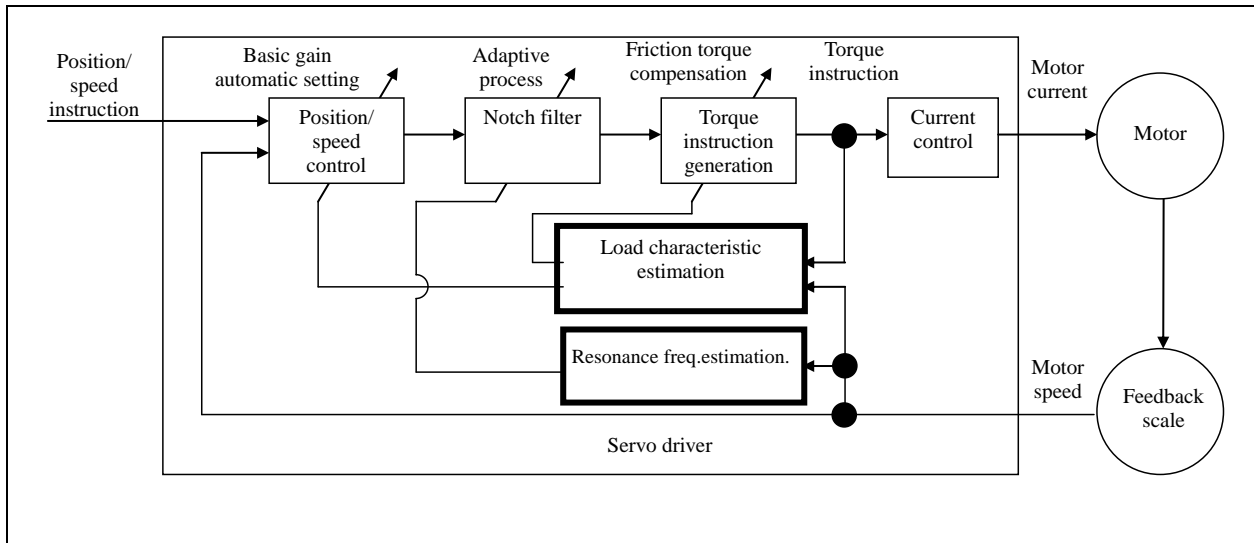

- 1) Real-time auto tuning
Estimates the load characteristics based on the motor velocity and torque command, and automatically sets up the basic gain related to position and velocity control, based on estimated inertia. Also estimates the friction torque at the same time and adds the estimated value to the torque command to shorten positioning settling time.
- 2) Adaptive filter
Estimates the resonance frequency based on the motor velocity and removes the frequency components from torque command to prevent resonant oscillation.

5-1-1 Real-Time Auto Tuning

The system estimates the load characteristics in real time, and automatically performs basic gain setting and friction compensation by referring to stiffness parameter.

For the 2 degrees of freedom control mode, refer to section 5-1-3/5-1-4.

1) Applicable Range

This function operates under the following conditions.

	Real-time auto-tuning condition
Control Mode	Specific real-time auto-tuning mode is selected according to the currently active control mode. For details, refer to the description of Pr 0.02 Real time auto-tuning setup.
Others	<ul style="list-style-type: none"> • Should be in servo-on condition • Parameters except for controls such as torque limit setup, are correctly set, assuring that the motor can run smoothly. • The mass ratio is not estimated and the thrust compensation value is not updated while estimating the pole position.

2) Cautions

- After the power is turned on, estimate value following may become quicker regardless of Pr6.31 “Real-time auto tuning estimation speed” until operation data effective for the estimation of load characteristics is sufficiently accumulated.
- When real-time auto-gain tuning is effective, an estimate value may become abnormal due to disturbance. If you want to obtain stable operation from when the power is turned on, it is recommended to disable the real-time auto-gain tuning.

Real-time auto-gain tuning may not be executed properly under the conditions described below. If not properly executed, change the loading condition or operating pattern, or manually set up the related parameters by referring to the manual adjustment function description.

	Conditions which obstruct real-time auto-gain tuning action
Load inertia	<ul style="list-style-type: none"> • The load inertia is too small or large compared to the rotor inertia. (less than 3 times or more than 20 times). • The load inertia changes too quickly. • The machine stiffness is extremely low. • Nonlinear characteristics such as backlash exist.
Action pattern	<ul style="list-style-type: none"> • The motor is running continuously at low speed of 100 [r/min] or lower. • Acceleration/deceleration is slow (2,000 [r/min] per 1 [s] or low). • When the speed condition of 100 [r/min] or more and acceleration/deceleration condition of 2,000 [r/min] per 1 [s] are not maintained for 50 [ms]. • Acceleration/deceleration torque is smaller than unbalanced weighted/viscous friction torque.
Others	<ul style="list-style-type: none"> • The feedback scale resolution is low. (1 μm/pulse or more) • The estimation accuracy of magnetic pole position estimation is low.

3) Real-time auto tuning control parameters

Use the following parameters to set up the operation of real-time auto tuning.

Class	No.	Attribute *1)	Title	Range	Unit	Function		
0	02	B	Real-time auto-gain tuning setup	0-6	—	You can set up the action mode of the real-time auto-gain tuning.		
						Setup value	Mode	Description
						0	Invalid	Real-time auto-gain tuning function is disabled.
						1	Standard	Stability-sensitive mode. Do not use unbalanced load, friction compensation or gain switching.
						2	Positioning *1	Position-sensitive mode. Use this mode for machine using horizontal axis without offset load or ball screw driven machine with small friction.
						3	Vertical axis *2	This mode adds the following features to those of positioning mode: compensates for offset load in vertical axis and minimizes positioning settling time variations.
						4	Friction compensation *3	This mode adds the following features to those of vertical axis mode: shortens positioning settling time on large friction system such as belt driven axis.
						5	Load characteristic measurement	This mode only estimates the load characteristics without changing the basic gain setting or friction compensation setting. Use these features in conjunction with the setup support software.
6	Customize *4	By precisely setting combination of real-time auto tuning functions through Pr 6.32 Real time auto tuning custom setup, customization to fit the application can be made.						
						*1 Velocity and torque controls are the same as in the standard mode.		
						*2 Torque control is the same as in the standard mode.		
						*3 Velocity control is the same as in the vertical axis mode. Torque control is the same as in the standard mode.		
						*4 Certain function(s) is not available in a specific control mode. Refer to description in Pr 6.32.		
0	03	B	Setup of machine stiffness at real-time auto-gain tuning	0-31	—	You can set up the response while the real-time auto-gain tuning is valid. Higher the setup value, higher the velocity response and servo stiffness will be obtained. However, when increasing the value, check the resulting operation to avoid oscillation or vibration.		
6	10	B	Function expansion setup	-32768-32767	—	The automatic adjustment of load change inhibit function is enabled with bit14=1.		

(To be continued)

Class	No.	Attribute *1)	Title	Range	Unit	Function															
6	31	B	Real time auto tuning estimation speed	0-3	—	<p>Set up the load characteristics estimation speed with the real time auto tuning being valid. A higher setup value assures faster response to a change in load characteristics but increases variations in disturbance estimation. Result of estimation is saved to EEPROM every 30 minutes.</p> <table border="1"> <thead> <tr> <th>Setup value</th> <th>Mode</th> <th>Description</th> </tr> </thead> <tbody> <tr> <td>0</td> <td>No change</td> <td>Stop estimation of load characteristics.</td> </tr> <tr> <td>1</td> <td>Almost constant</td> <td>Response to changes in load characteristics in every minute.</td> </tr> <tr> <td>2</td> <td>Slower change</td> <td>Response to changes in load characteristics in every second.</td> </tr> <tr> <td>3 *</td> <td>Faster change</td> <td>Obtain best suitable estimation in response to changes in load characteristics.</td> </tr> </tbody> </table> <p>* If the automatic oscillation detection is enabled by the support software, the setup value 3 is used.</p>	Setup value	Mode	Description	0	No change	Stop estimation of load characteristics.	1	Almost constant	Response to changes in load characteristics in every minute.	2	Slower change	Response to changes in load characteristics in every second.	3 *	Faster change	Obtain best suitable estimation in response to changes in load characteristics.
Setup value	Mode	Description																			
0	No change	Stop estimation of load characteristics.																			
1	Almost constant	Response to changes in load characteristics in every minute.																			
2	Slower change	Response to changes in load characteristics in every second.																			
3 *	Faster change	Obtain best suitable estimation in response to changes in load characteristics.																			
6	32	B	Real time auto tuning custom setup (To be continued)	-32768-32767	—	<p>When the operation mode of real time auto tuning is set to the customize (Pr 0.02 = 6), set the automatic adjusting function as shown below.</p> <table border="1"> <thead> <tr> <th>Bit</th> <th>Content</th> <th>Description</th> </tr> </thead> <tbody> <tr> <td>1-0</td> <td>Load characteristics estimation *1,*2</td> <td>Enable/disable the load characteristics estimation function. Setup value=0: Disable Setup value=1: Enable</td> </tr> <tr> <td>3-2</td> <td>Inertia ratio update *3</td> <td>Set up update to be made based on result of the load characteristics estimation of Pr 0.04 "Inertia ratio". Setup value=0: Use current setup. Setup value=1: Update by the estimated value.</td> </tr> <tr> <td>6-4</td> <td>Torque compensation *4</td> <td>Set up the update to be made according to the results of load characteristics estimation of Pr 6.07 "Torque command additional value", Pr 6.08 "positive direction torque compensation value" and Pr 6.09 "negative direction torque compensation value". Setup value = 0: Use current setup Setup value = 1: Disable torque compensation. Clear the parameters shown above to 0. Setup value = 2: Vertical axis mode Update Pr 6.07. Zero clear Pr 6.08 and Pr 6.09 Setup value = 3: Friction compensation (low) Update Pr 6.07. Set low compensation to Pr 6.08 and Pr 6.09. Setup value = 4: Friction compensation (middle) Set middle compensation to Pr 6.08 and Pr 6.09. Setup value = 5: Friction compensation (high) Set high compensation to Pr 6.08 and Pr 6.09.</td> </tr> </tbody> </table> <p>*1 If the load characteristics estimation is disabled, the current setup cannot be changed even if the inertia ratio is updated according to the estimated value. When the torque compensation is updated by the estimated value, it is cleared to 0 (invalid). *2 If the load characteristics estimation is abled, set Pr6.31 "Real-time auto tuning presumption speed" besides 0(stop estimation).</p>	Bit	Content	Description	1-0	Load characteristics estimation *1,*2	Enable/disable the load characteristics estimation function. Setup value=0: Disable Setup value=1: Enable	3-2	Inertia ratio update *3	Set up update to be made based on result of the load characteristics estimation of Pr 0.04 "Inertia ratio". Setup value=0: Use current setup. Setup value=1: Update by the estimated value.	6-4	Torque compensation *4	Set up the update to be made according to the results of load characteristics estimation of Pr 6.07 "Torque command additional value", Pr 6.08 "positive direction torque compensation value" and Pr 6.09 "negative direction torque compensation value". Setup value = 0: Use current setup Setup value = 1: Disable torque compensation. Clear the parameters shown above to 0. Setup value = 2: Vertical axis mode Update Pr 6.07. Zero clear Pr 6.08 and Pr 6.09 Setup value = 3: Friction compensation (low) Update Pr 6.07. Set low compensation to Pr 6.08 and Pr 6.09. Setup value = 4: Friction compensation (middle) Set middle compensation to Pr 6.08 and Pr 6.09. Setup value = 5: Friction compensation (high) Set high compensation to Pr 6.08 and Pr 6.09.			
Bit	Content	Description																			
1-0	Load characteristics estimation *1,*2	Enable/disable the load characteristics estimation function. Setup value=0: Disable Setup value=1: Enable																			
3-2	Inertia ratio update *3	Set up update to be made based on result of the load characteristics estimation of Pr 0.04 "Inertia ratio". Setup value=0: Use current setup. Setup value=1: Update by the estimated value.																			
6-4	Torque compensation *4	Set up the update to be made according to the results of load characteristics estimation of Pr 6.07 "Torque command additional value", Pr 6.08 "positive direction torque compensation value" and Pr 6.09 "negative direction torque compensation value". Setup value = 0: Use current setup Setup value = 1: Disable torque compensation. Clear the parameters shown above to 0. Setup value = 2: Vertical axis mode Update Pr 6.07. Zero clear Pr 6.08 and Pr 6.09 Setup value = 3: Friction compensation (low) Update Pr 6.07. Set low compensation to Pr 6.08 and Pr 6.09. Setup value = 4: Friction compensation (middle) Set middle compensation to Pr 6.08 and Pr 6.09. Setup value = 5: Friction compensation (high) Set high compensation to Pr 6.08 and Pr 6.09.																			

(To be continued)

Class	No.	Attribute *1)	Title	Range	Unit	Function												
6	32	B	Real time auto tuning custom setup (Continued)	-32768~32767	—	<table border="1"> <thead> <tr> <th>Bit</th> <th>Content</th> <th>Description</th> </tr> </thead> <tbody> <tr> <td>7</td> <td>Stiffness Setup *5</td> <td>Enable/disable the basic gain setup to be made according to Pr0.03 (Real-time auto-tuning machine stiffness setup). Setup value=0: Disable Setup value=1: Enable</td> </tr> <tr> <td>8</td> <td>Fixed parameter setup *5</td> <td>Enable/disable the change of parameter that is normally set at a fixed value. Setup value=0: Use current setup Setup value=1: Set to a fixed value.</td> </tr> <tr> <td>10-9</td> <td>Gain switching setup *5</td> <td>Select the gain switching related parameter to be used when the real time auto tuning is enabled. Setup value=0: Use current setup Setup value=1: Disable gain switching. Setup value=2: Enable gain switching.</td> </tr> </tbody> </table> <p>*3 If the inertia ratio update is enabled, set bit 1-0 to 1(enable). If neither is effective, the inertia ratio is not updated.</p> <p>*4 If the torque compensation is enabled (setup value=2-5), set bit 3-2(Inertia ratio update) to 1(enable). If neither is effective, the inertia ratio is not updated. The torque compensation alone cannot be updated.</p> <p>*5 Set bit3-2(Inertia ratio update) to 1(enable) when this setting is set excluding 0. At this time, you can be set whether to inertia ratio update to be effective with bit 1-0(Load characteristics estimation).</p> <p>Caution) This parameter should be setup bit by bit. Because the operation is not guaranteed when the setting is wrong, use of the setup support software is recommended for parameter editing.</p> <p>Caution) Do not change while the motor is operating. With this parameter is updated, when the motor stopped after the result of load characteristic measurement secured.</p> <p><Setup procedure of bitwise parameter> When setting parameter to a value other than 0, calculate the setup value of Pr 6.32 in the following procedure.</p> <ol style="list-style-type: none"> 1) Identify the LSB of the setup. Example: LSB of the torque compensation function is 4. 2) Multiply the setup value by power of 2 (LSB). Example: To set the torque compensation function to friction compensation (middle): $2^4 \times 4 = 64$. 3) Perform steps 1) and 2) for every setup, sum up the values which are to be Pr 6.32 setup values. Example: Load characteristics measurement = enable, inertia ratio update = enable, torque compensation = friction compensation (middle), stiffness setup = enable, fixed parameter = set to a fixed value, gain switching setup = enable, then, $2^0 \times 1 + 2^2 \times 1 + 2^4 \times 4 + 2^7 \times 1 + 2^8 \times 1 + 2^9 \times 2 = 1477$ 	Bit	Content	Description	7	Stiffness Setup *5	Enable/disable the basic gain setup to be made according to Pr0.03 (Real-time auto-tuning machine stiffness setup). Setup value=0: Disable Setup value=1: Enable	8	Fixed parameter setup *5	Enable/disable the change of parameter that is normally set at a fixed value. Setup value=0: Use current setup Setup value=1: Set to a fixed value.	10-9	Gain switching setup *5	Select the gain switching related parameter to be used when the real time auto tuning is enabled. Setup value=0: Use current setup Setup value=1: Disable gain switching. Setup value=2: Enable gain switching.
Bit	Content	Description																
7	Stiffness Setup *5	Enable/disable the basic gain setup to be made according to Pr0.03 (Real-time auto-tuning machine stiffness setup). Setup value=0: Disable Setup value=1: Enable																
8	Fixed parameter setup *5	Enable/disable the change of parameter that is normally set at a fixed value. Setup value=0: Use current setup Setup value=1: Set to a fixed value.																
10-9	Gain switching setup *5	Select the gain switching related parameter to be used when the real time auto tuning is enabled. Setup value=0: Use current setup Setup value=1: Disable gain switching. Setup value=2: Enable gain switching.																

*1) For parameter attribute, refer to Section 9-1.

4) Parameters changed by real-time auto-gain tuning

The real-time auto-tuning function updates the following parameters according to Pr 0.02 “Real-time auto-tuning setup” and Pr 6.32 “Real-time auto-tuning custom setup” and by using the load characteristic estimate values.

Class	No.	Attribute *1)	Title	Range	Unit	Function
0	04	B	Inertia ratio	0–20000	%	Updates this parameter when the real-time auto-tuning inertia ratio update is enabled.
6	07	B	Torque command additional value	-100–100	%	Update this parameter when the vertical axis mode for real time auto-tuning is valid.
6	08	B	Positive direction Torque Compensation Value	-100–100	%	Update this parameter when the friction compensation mode for real time auto-tuning is valid.
6	09	B	Negative direction torque compensation value	-100–100	%	Update this parameter when the friction compensation mode for real time auto-tuning is valid.

The real-time auto-tuning function updates the following basic gain setup parameters according to Pr0.03 “Real-time auto-tuning machine stiffness setup”. For details, refer to 7) Basic gain parameter setup table.

Class	No.	Attribute *1))	Title	Range	Unit	Function
1	00	B	1st gain of position loop	0–30000	0.1/s	When stiffness setup is valid, updates the parameter based on the setup value.
1	01	B	1st gain of velocity loop	1–32767	0.1 Hz	When stiffness setup is valid, updates the parameter based on the setup value.
1	02	B	1st time constant of velocity loop integration	1–10000	0.1 ms	When stiffness setup is valid, updates the parameter based on the setup value.
1	04	B	1st time constant of torque filter	0–2500	0.01 ms	When stiffness setup is valid, updates the parameter based on the setup value.
1	05	B	2nd gain of position loop	0–30000	0.1/s	When stiffness setup is valid, updates the parameter based on the setup value.
1	06	B	2nd gain of velocity loop	1–32767	0.1 Hz	When stiffness setup is valid, updates the parameter based on the setup value.
1	07	B	2nd time constant of velocity loop integration	1–10000	0.1 ms	When stiffness setup is valid, updates the parameter based on the setup value.
1	09	B	2nd time constant of torque filter	0–2500	0.01 ms	When stiffness setup is valid, updates the parameter based on the setup value.

Real-time auto-tuning function sets the following parameters to the fixed value.

Class	No.	Attribute *1)	Title	Range	Unit	Function
1	03	B	1st filter of velocity detection	0–5	—	When fixed parameter setup is valid, set the parameter to 0.
1	08	B	2nd filter of velocity detection	0–5	—	When fixed parameter setup is valid, set the parameter to 0.
1	10	B	Velocity feed forward gain	0–4000	0.1%	When fixed parameter setup is valid, set the parameter to 300 (30%).
1	11	B	Velocity feed forward filter	1–6400	0.01 ms	When fixed parameter setup is valid, set the parameter to 50 (0.5 ms).
1	12	B	Torque feed forward gain	0–2000	0.1%	When fixed parameter setup is valid, set the parameter to 0.
1	13	B	Torque feed forward filter	0–6400	0.01 ms	When fixed parameter setup is valid, set the parameter to 0.

(To be continued)

The real-time auto-tuning function sets the following parameters as the gain is switched.

Class	No.	Attribute *1)	Title	Range	Unit	Function
1	14	B	2nd gain setup	0-1	—	Sets to 1 if the current setting is not maintained
1	15	B	Mode of position control switching	0-10	—	Sets to 10 to enable the gain switching. Sets to 0 to disable the gain switching.
1	16	B	Delay time of position control switching	0-10000	0.1 ms	Sets to 50 if the current setting is not maintained.
1	17	B	Level of position control switching	0-20000	—	Sets to 50 if the current setting is not maintained.
1	18	B	Hysteresis at position control switching	0-20000	—	Sets to 33 if the current setting is not maintained.
1	19	B	Position gain switching time	0-10000	0.1 ms	Sets to 33 if the current setting is not maintained.
1	20	B	Mode of velocity control switching	0-5	—	Sets to 0 if the current setting is not maintained.
1	21	B	Delay time of velocity control switching	0-10000	0.1 ms	Sets to 0 if the current setting is not maintained.
1	22	B	Level of velocity control switching	0-20000	—	Sets to 0 if the current setting is not maintained.
1	23	B	Hysteresis at velocity control switching	0-20000	—	Sets to 0 if the current setting is not maintained.
1	24	B	Mode of torque control switching	0-3	—	Sets to 0 if the current setting is not maintained.
1	25	B	Delay time of torque control switching	0-10000	0.1 ms	Sets to 0 if the current setting is not maintained.
1	26	B	Level of torque control switching	0-20000	—	Sets to 0 if the current setting is not maintained.
1	27	B	Hysteresis at torque control switching	0-20000	—	Sets to 0 if the current setting is not maintained.

The following settings are always set to invalid when Pr 0.02 “Real-time auto-tuning setup” is not 0. However, the parameter settings are not changed.

Class	No.	Attribute *1)	Title	Range	Unit	Function
6	10	B	Function expansion setup	0-1023	—	Instantaneous velocity observer function enable bit (bit 0), disturbance observer function enable bit (bit 1) are internally disabled.
6	23	B	Load change compensation gain	-100-100	%	Parameter setup can be changed, but disturbance observer is disabled.
6	24	B	Load change compensation filter	10-2500	0.01 ms	Parameter setup can be changed, but disturbance observer is disabled.
6	73	B	Load estimation filter	0-2500	0.01 ms	When set to Pr 6.10 bit14=1 in case of stiffness setting is enabled, sets to 0.13 ms. When set to Pr 6.10 bit14=0, set to 0 ms.
6	74	B	Torque compensation frequency 1	0-5000	0.1 Hz	Regardless value of the Pr 6.10 bit 14, sets to 0.
6	75	B	Torque compensation frequency 2	0-5000	0.1 Hz	Regardless value of the Pr 6.10 bit14 , sets to 0.
6	76	B	Load estimation count	0-8	-	When set to Pr 6.10 bit14=1 in case of stiffness setting is enabled, sets to 4.

*1) For parameter attribute, refer to Section 9-1.

- 5) How to use
 When Pr 0.02 (Setup of real-time auto-gain tuning mode) is set to a value other than 0, control parameter is automatically set according to Pr0.03 “Real-time auto-tuning machine stiffness setup”.
 When the servo is ON, enter operation command after about 100ms. When the load characteristic is correctly estimated, Pr 0.04 Inertia ratio is updated. With certain mode settings, Pr 6.07 Torque command addition value, Pr 6.08 Positive direction compensation value and Pr 6.09 Negative direction compensation value will be changed.
 When value of Pr0.03 “Real-time auto-tuning machine stiffness setup” is increased, the motor responsiveness will be improved. Determine the most appropriate stiffness in relation to the positioning setup time and vibration condition.
- 6) Other cautions
- [1] Immediately after the first servo-on upon start up; or after increasing Pr0.03 “Real-time auto-tuning machine stiffness setup”, abnormal sound or oscillation may be generated until the load characteristics is stabilized. If such abnormality lasts or repeats for 3 or more reciprocating operations, take the following countermeasures.
- 1) Lower the setting value of Pr0.03 “Real-time auto-tuning machine stiffness setup”.
 - 2) Set Pr 0.02 Real-time auto-tuning setup to 0 to disable the real-time auto-tuning.
 - 3) Set Pr 0.04 Inertial ratio to the calculational value of the equipment and set Pr 6.07 Torque command addition value, Pr 6.08 Positive direction compensation value and Pr 6.09 Negative direction compensation value to 0.
- [2] When abnormal noise and oscillation occur, Pr 0.04 (Inertia ratio) or Pr 6.07 (Torque command additional value), Pr 6.08 (Positive direction torque compensation value), Pr 6.09 (Negative direction torque compensation value) might have changed to extreme values. Take the same measures as described in the setp 3) above in these cases.
- [3] Among the results of real-time auto-gain tuning, Pr 0.04 (Inertia ratio) and Pr 6.07 (Torque command additional value), Pr 6.08 (Positive direction torque compensation value), Pr 6.09 (Negative direction torque compensation value) will be written to EEPROM every 30 minutes. When you turn on the power again, the auto-gain tuning will be executed using the latest data as initial values. If power is turned off within 30 minutes after the end of tuning process, the result of the real-time auto-tuning is not saved. If the result is not saved, manually write parameters to EEPROM and then turn off power.
- [4] The control gain is updated when the motor is stopped. Therefore, if motor is not stopped because gain is excessively low or commands are given continually in one direction, the change in Pr0.03 “Real-time auto-tuning machine stiffness setup” may not be reflected. In this case, abnormal sound or oscillation may be generated depending on the stiffness setting that is reflected after the motor stops.
 After the stiffness setting is changed, be sure to stop the motor and check that the stiffness setting is reflected before performing next operation.

7) Basic gain parameter setup table

Stiffness	1st gain				2nd gain				For load fluctuation suppression function
	Pr 1.00	Pr 1.01	Pr 1.02	Pr 1.04	Pr 1.05	Pr 1.06	Pr 1.07 *1	Pr 1.09	Pr 6.24
	Position [0.1/s]	Velocity [0.1 Hz]	Velocity loop integration [0.1 ms]	Torque [0.01 ms]	Position [0.1/s]	Velocity [0.1 Hz]	Velocity loop integration [0.1 ms]	Torque [0.01 ms]	Load fluctuation compensation filter [0.01/ms]
0	20	15	3700	1500	25	15	10000	1500	2500
1	25	20	2800	1100	30	20	10000	1100	2500
2	30	25	2200	900	40	25	10000	900	2500
3	40	30	1900	800	45	30	10000	800	2500
4	45	35	1600	600	55	35	10000	600	2500
5	55	45	1200	500	70	45	10000	500	2500
6	75	60	900	400	95	60	10000	400	2500
7	95	75	700	300	120	75	10000	300	2120
8	115	90	600	300	140	90	10000	300	1770
9	140	110	500	200	175	110	10000	200	1450
10	175	140	400	200	220	140	10000	200	1140
11	320	180	310	126	380	180	10000	126	880
12	390	220	250	103	460	220	10000	103	720
13	480	270	210	84	570	270	10000	84	590
14	630	350	160	65	730	350	10000	65	450
15	720	400	140	57	840	400	10000	57	400
16	900	500	120	45	1050	500	10000	45	320
17	1080	600	110	38	1260	600	10000	38	270
18	1350	750	90	30	1570	750	10000	30	210
19	1620	900	80	25	1880	900	10000	25	180
20	2060	1150	70	20	2410	1150	10000	20	140
21	2510	1400	60	16	2930	1400	10000	16	110
22	3050	1700	50	13	3560	1700	10000	13	90
23	3770	2100	40	11	4400	2100	10000	11	80
24	4490	2500	40	9	5240	2500	10000	9	60
25	5000	2800	35	8	5900	2800	10000	8	60
26	5600	3100	30	7	6500	3100	10000	7	50
27	6100	3400	30	7	7100	3400	10000	7	50
28	6600	3700	25	6	7700	3700	10000	6	40
29	7200	4000	25	6	8400	4000	10000	6	40
30	8100	4500	20	5	9400	4500	10000	5	40
31	9000	5000	20	5	10500	5000	10000	5	40

*1 In the vertical axis mode or friction compensation mode (Pr0.02=3,4), Pr1.07 is kept at 9999 until load characteristic estimation is completed.

5-1-2 Adaptive filter

This function estimates the resonance frequency from the vibrating component which appears on the motor velocity, and removes the resonance component from the torque command with adaptive filter, thus reduces the resonance vibration.

1) Applicable Range

This function works under the following condition.

Conditions under which the Adaptive filter is activated	
Control mode	Applies to other control modes than torque control.
Others	<ul style="list-style-type: none"> • Should be servo-on status. • Elements other than control parameters, such as deviation counter clear command inhibit and torque limit are appropriately set, enabling the motor to run normally. • Adaptive operation will not be executed during magnetic pole position estimation. • In homing position mode, Adaptive filter cannot be used together either Damping Control or Quadrant projection suppression function or Position comparison function or Deterioration diagnosis warning function.

2) Cautions

In the following condition, normal operation may not be expected—manually set the notch filter to prevent resonance.

Conditions which obstruct adaptive filter action	
Resonance point	<ul style="list-style-type: none"> • Resonance frequency is lower than the velocity response frequency $\times 3$ (Hz). • Resonance peak is low, or control gain is low where the motor velocity is not affected by this. • Three or more resonance points exist.
Load	<ul style="list-style-type: none"> • Motor velocity variation with high harmonic component is generated due to non-linear factors such as backlash.
Command	<ul style="list-style-type: none"> • Acceleration/deceleration is rapid such as 30000 [r/min] per 1 [s].
Others	<ul style="list-style-type: none"> • The feedback scale resolution is low. (1 μm/pulse or more) • The feedback scale resolution is high. (0.01 μm/pulse or less)

3) Relevant parameters

Set the operation of the adaptive filter to the following parameter.

Class	No.	Attribute *1)	Title	Range	Unit	Function
2	00	B	Adaptive filter mode setup	0-6	—	<p>Select the operation mode of adaptive filter:</p> <p>Setup value 0: Adaptive filter: invalid The adaptive filter is disabled. Parameters related to the 3rd and 4th notch filter hold the current value.</p> <p>Setup value 1: Adaptive filter: 1 filter is valid One adaptive filter is enabled. Parameters related to the 3rd notch filter will be updated based on adaptive performance.</p> <p>Setup value 2: Adaptive filter: 2 filters are valid Two adaptive filters are enabled. Parameters related to the 3rd and 4th notch filters will be updated based on adaptive performance.</p> <p>Setup value 3: Resonance frequency measurement mode Measure the resonance frequency. Result of measurement can be checked with the setup support software PANATERM. Parameters related to the 3rd and 4th notch filter hold the current value.</p> <p>Setup value 4: Clear result of adaptation Parameters related to the 3rd and 4th notch filter are disabled and results of adaptive operation are cleared.</p> <p>Setup value 5: High accurate adaptive filter Two adaptive filters are enabled. Parameters related to the third and fourth notch filter are updated depending on adaptive results. We recommend this setting when using two adaptive filters.</p> <p>Setup value 6: Maker uses. It is the fit gain function of setup support software PANATERM, and internally used. Do not use this setting in normal conditions.</p>

The adaptive filter automatically sets up the following parameters.

Class	No.	Attribute *1)	Title	Range	Unit	Function
2	07	B	3rd notch frequency	50-5000	Hz	Notch frequency is automatically set to the 1st resonance frequency estimated by the adaptive filter. In no resonance point is found, the frequency is set to 5000.
2	08	B	3rd notch width selection	0-20	—	Automatically set when the adaptive filter is active.
2	09	B	3rd notch depth selection	0-99	—	Automatically set when the adaptive filter is active.
2	10	B	4th notch frequency	50-5000	Hz	Notch frequency is automatically set to the 2nd resonance frequency estimated by the adaptive filter. In no resonance point is found, the frequency is set to 5000.
2	11	B	4rd notch width selection	0-20	—	Automatically set when 2 adaptive filters are active.
2	12	B	4rd notch depth selection	0-99	—	Automatically set when 2 adaptive filters are active.

*1) For parameter attribute, refer to Section 9-1.

- 4) How to use
Enter the action command with Pr2.00 (Adaptive filter mode setup) set to a value other than 0.
If the resonance point affects the motor velocity, parameters of 3rd notch filter and/or 4th notch filters are automatically set according to the number of adaptive filters.
- 5) Other cautions
 - (1) Immediately after the first servo-on at start up; or after increasing stiffness setting with the real-time auto-tuning enabled, abnormal sound or oscillation may be generated until the adaptive filter stabilizes. If such abnormality lasts or repeats for 3 or more reciprocating operations, take the following countermeasures.
 - 1) Write the parameters which have given the normal operation into EEPROM.
 - 2) Lower the setting value of Pr0.03 (Real-time auto-tuning machine stiffness setup).
 - 3) Invalidate the adaptive filter by setting Pr2.00 (Adaptive filter mode setup) to 0.
 - 4) Set up the notch filter manually.
 - (2) Abnormal sound or oscillation may excessively change the setup value of 3rd and 4th notch filters. If such change occurs, disable the adaptive filter as described in step 3) above, change setup value of Pr 2.07 3rd notch frequency and Pr 2.10 "4th notch frequency" to 5000 (disable), and then enable the adaptive filter again.
 - (3) The 3rd filters (Pr 2.07) and 4th notch filters (Pr 2.10) are written to EEPROM every 30minutes. Upon power up, these data are used as default values during adaptive process.

5-1-3 Real-time Auto Tuning (Two-degree-of-Freedom control mode Standard type)

The results from the real-time estimation of the machine load characteristics automatically implement the basis gain setting and load variation compensation depending on the stiffness parameter.

Note: Two-degree-of-freedom control mode has the standard type and synchronization type.
However only standard type is available on MINAS-A6BL series.

1) Applicable Range

This function is enabled under the following conditions:

Conditions for real-time auto tuning	
Control mode	Position Control, Speed Control, Torque Control Pr6.47 bit0=1 and bit3=0: 2 Degrees of Freedom Control Mode Standard type
Other	<ul style="list-style-type: none"> · In Servo On status. · Parameters for other functions than control such as torque limit settings must be specified appropriately and normal rotation of motor must have no problems.

2) Cautions

- After the power is turned on, estimate value following may become quicker regardless of Pr6.31 "Real-time auto tuning estimation speed" until operation data effective for the estimation of load characteristics is sufficiently accumulated.
- When real-time auto-gain tuning is effective, an estimate value may become abnormal due to disturbance. If you want to obtain stable operation from when the power is turned on, it is recommended to disable the real-time auto-gain tuning.

Real-time auto tuning may not normally function in the following conditions. If that happens, change the load conditions/operation pattern or see the descriptions about manual tuning to manually configure relevant parameters.

Conditions hindering real-time auto tuning	
Load condition	<ul style="list-style-type: none"> · The load mass is too small or large with reference to the rotor mass (smaller than three times or 20 times or larger). · The load mass varies. · The mechanical stiffness is extremely low. · Any non-linear characteristic exists such as backlash.
Operation pattern	<ul style="list-style-type: none"> · Continuous use at a low speed of less than 100 [mm/s] · The acceleration is low at 2000 [mm/s] per 1 [s]. · A speed at 100 [mm/s] or higher or a acceleration/deceleration of 2000 [mm/s] per 1 [s] does not continue for 50 [ms] or longer. · The acceleration/deceleration torque is small with reference to the uneven load/ viscous friction torque.
Other	<ul style="list-style-type: none"> · The feedback scale resolution is low. (1 μm/pulse or more) · The estimation accuracy of magnetic pole position estimation is low.

3) Parameters controlling operation of real-time auto tuning

Configure the real-time auto tuning operation by setting the following parameters.

Class	No.	Attribute *1)	Title	Range	Unit	Function		
0	02	B	Real-time auto-gain tuning setup	0-6	—	Specifies the operation mode of real-time auto tuning.		
						Setting	Mode	Description
						0,6	Invalid	The real-time auto tuning function is disabled.
						1	Standard response mode	The mode for the optimum stability. No uneven load or friction compensation takes place and no gain switching is used.
						2	High response mode 1	The mode for the optimum positioning. Used for a ball screw-driven device, etc. with no uneven load and little friction, as in a horizontal axis.
						3	High response mode 2	In addition to the high response mode 1, compensation against biased load and application of 3rd gain are made to reduce variations in settling time of positioning.
						4	High response mode 3 *1	In addition to the high response mode 2, settling time of positioning is reduced for a load where frictions are high.
						5	Load characteristic measurement	Basic gain settings and friction compensation settings are not changed and load characteristic estimation only is made. This is used in combination with setup support software.
6	Fit-gain mode	Use this mode to fine-adjust the stiffness setting after fit-gain has been completed.						
						*1: In velocity control, it is the same as high response mode 2. In addition, Parameters of Pr6.08 "Positive direction torque compensation value", Pr6.09 "Negative direction torque compensation value" and Pr6.50 "Viscous friction compensation gain" are updated, but not reflected in the operation.		
0	03	B	Real-time auto-tuning machine stiffness setup	0-31	—	Specifies the response for enabled real-time auto tuning. A larger setting increases the speed response and servo stiffness but invites more vibration. Gradually increase the setting while monitoring the operation.		
6	10	B	Function expansion setup	-32768-32767	—	The automatic adjustment of load change inhibit function is enabled with bit14=1.		

(To be continued)

Class	No.	At-tribute *1)	Title	Range	Unit	Function		
6	31	B	Real time auto tuning estimation speed	0-3	—	Specifies the load characteristics estimation speed for enabled real-time auto tuning. A larger setting allows faster follow-up to the variation in the load characteristics but also increases estimation fluctuation due to disturbance. The result of estimation is stored in the EEPROM every 30 minutes.		
						Setting	Mode	Description
						0	No change	Terminates estimation of load characteristic.
						1	Little change	Responded against change of load characteristic on the order of minutes.
						2	Gradual change	Responded against change of load characteristic on the order of seconds.
3 *	Steep change	Appropriate estimation is made against change of load characteristic.						
						* If oscillation automatic detection is made valid from setup support software, this setting is ignored and operation is based on settings of setting value 3.		
6	32	B	Real time auto tuning custom setup	-32768-32767	—	Not available in 2 degrees of freedom control mode. Always set to 0.		

*1) For parameter attribute, refer to Section 9-1.

4) Parameter changed by real-time auto tuning

The real-time auto tuning function updates the following parameters using load characteristic values, in accordance with Pr0.02 "Real-time auto-gain tuning setup."

Class	No.	Attribute *1)	Title	Range	Unit	Function
0	04	B	Inertia ratio	0–20000	%	Updates this parameter when the real-time auto tuning inertia ratio update is enabled (Pr0.02=1 to 4).
6	07	B	Torque command additional value	-100–100	%	Updates this parameter when high response mode 2 or 3 (Pr0.02=3,4) for real-time auto tuning is selected.
6	08	B	Positive direction torque compensation value	-100–100	%	Updates this parameter when high response mode 3 (Pr0.02=4) for real-time auto tuning is selected.
6	09	B	Negative direction torque compensation value	-100–100	%	Updates this parameter when high response mode 3 (Pr0.02=3) for real-time auto tuning is selected.
6	50	B	Viscous friction compensating gain	0–10000	0.1%/ (10000r/min)	Updates this parameter when high response mode 3 (Pr0.02=3) for real-time auto tuning is selected.

The real-time auto tuning function updates the following basic gain setup parameters according to Pr0.03 "Real-time auto-tuning machine stiffness setup". For details, refer to 7) Basic gain parameter settings table.

Class	No.	Attribute *1)	Title	Range	Unit	Function
1	00	B	1st gain of position loop	0–30000	0.1/s	When stiffness setup is valid (Pr0.02=1 to 4), updates the parameter based on the setup value.
1	01	B	1st gain of velocity loop	1–32767	0.1 Hz	When stiffness setup is valid (Pr0.02=1 to 4), updates the parameter based on the setup value.
1	02	B	1st time constant of velocity loop integration	1–10000	0.1 ms	When stiffness setup is valid (Pr0.02=1 to 4), updates the parameter based on the setup value.
1	04	B	1st time constant of torque filter	0–2500	0.01 ms	When stiffness setup is valid (Pr0.02=1 to 4), updates the parameter based on the setup value.
1	05	B	2nd gain of position loop	0–30000	0.1/s	When stiffness setup is valid (Pr0.02=1 to 4), updates the parameter based on the setup value.
1	06	B	2nd gain of velocity loop	1–32767	0.1 Hz	When stiffness setup is valid (Pr0.02=1 to 4), updates the parameter based on the setup value.
1	07	B	2nd time constant of velocity loop integration	1–10000	0.1 ms	When stiffness setup is valid (Pr0.02=1 to 4), updates the parameter based on the setup value.
1	09	B	2nd time constant of torque filter	0–2500	0.01 ms	When stiffness setup is valid (Pr0.02=1 to 4), updates the parameter based on the setup value.
2	22	B	Command smoothing filter	0–10000	0.1 ms	When stiffness setup is valid (Pr0.02=1 to 4), updates the parameter based on the setup value. Sets the time constant for the command filter during 2 degrees of freedom control.
6	48	B	Adjust filter	0–2000	0.1 ms	When stiffness setup is valid (Pr0.02=1 to 4), updates the parameter based on the setup value.

Real-time auto-tuning function sets the following parameters to the fixed value.

Class	No.	Attribute *1)	Title	Range	Unit	Function
1	03	B	1st filter of velocity detection	0–5	–	When fixed parameter setup is valid (Pr0.02=1 to 4), set the parameter to 0.
1	08	B	2nd filter of velocity detection	0–5	–	When fixed parameter setup is valid (Pr0.02=1 to 4), set the parameter to 0.
1	10	B	Velocity feed forward gain	0–4000	0.1%	When fixed parameter setup is valid (Pr0.02=1 to 4), set the parameter to 1000 (100%).
1	11	B	Velocity feed forward filter	0–6400	0.01 ms	When fixed parameter setup is valid (Pr0.02=1 to 4), set the parameter to 0 (invalid).

(To be continued)

Class	No.	Attribute *1)	Title	Range	Unit	Function
1	12	B	Torque feed forward gain	0–2000	0.1%	When fixed parameter setup is valid (Pr0.02=1 to 4), set the parameter to 1000 (100%).
1	13	B	Torque feed forward filter	0–6400	0.01 ms	When fixed parameter setup is valid (Pr0.02=1 to 4), set the parameter to 0 (invalid).
6	10	B	Function expansion setup	-32768–32767	–	When fixed parameter setup is valid (Pr0.02=1 to 4), set the parameter to bit4=1.
6	49	B	Adjust/Torque command attenuation term	0–99	–	When fixed parameter setup is valid (Pr0.02=1 to 4), set the parameter to 15. When Pr0.02=6, set the tenths digit to 1 and maintain the unit digit.

The real-time auto-tuning function sets the following parameters as the gain is switched.

Class	No.	Attribute *1)	Title	Range	Unit	Function
1	14	B	2nd gain setup	0–1	–	Sets to 1 if the current setting is not maintained (Pr0.02=1 to 4).
1	15	B	Mode of position control switching	0–10	–	For the standard response mode (Pr0.02=1), set the parameter to 0. For high response mode 1 to 3 (Pr0.02=2 to 4), set the parameter to 7.
1	16	B	Delay time of position control switching	0–10000	0.1 ms	Sets to 10 if the current setting is not maintained (Pr0.02=1 to 4).
1	17	B	Level of position control switching	0–20000	–	Sets to 0 if the current setting is not maintained (Pr0.02=1 to 4).
1	18	B	Hysteresis at position control switching	0–20000	–	Sets to 0 if the current setting is not maintained (Pr0.02=1 to 4).
1	19	B	Position gain switching time	0–10000	0.1 ms	Sets to 10 if the current setting is not maintained (Pr0.02=1 to 4).
1	20	B	Mode of velocity control switching	0–5	–	Sets to 0 if the current setting is not maintained (Pr0.02=1 to 4).
1	21	B	Delay time of velocity control switching	0–10000	0.1 ms	Sets to 0 if the current setting is not maintained (Pr0.02=1 to 4).
1	22	B	Level of velocity control switching	0–20000	–	Sets to 0 if the current setting is not maintained (Pr0.02=1 to 4).
1	23	B	Hysteresis at velocity control switching	0–20000	–	Sets to 0 if the current setting is not maintained (Pr0.02=1 to 4).
1	24	B	Mode of torque control switching	0–3	–	Sets to 0 if the current setting is not maintained (Pr0.02=1 to 4).
1	25	B	Delay time of torque control switching	0–10000	0.1 ms	Sets to 0 if the current setting is not maintained (Pr0.02=1 to 4).
1	26	B	Level of torque control switching	0–20000	–	Sets to 0 if the current setting is not maintained (Pr0.02=1 to 4).
1	27	B	Hysteresis at torque control switching	0–20000	–	Sets to 0 if the current setting is not maintained (Pr0.02=1 to 4).
6	05	B	Position 3rd gain valid time	0–10000	0.1 ms	For the standard response mode or high response mode 1 (Pr0.02=1, 2), set the parameter to 0 (invalid). For high response mode 2 or 3 (Pr0.02=3,4), set the parameter to "Pr2.22 × 20". (However, the maximum value is limited to 10000.)
6	06	B	Position 3rd gain scale factor	50–1000	%	For the standard response mode or high response mode 1 (Pr0.02=1,2), set the parameter to 100 (100%). For high response mode 2 or 3 (Pr0.02=3,4), set the parameter to 200 (200%).

(To be continued)

When Pr0.02 “Real-time auto-gain tuning setup” = 1 to 4 or 6, the following settings and parameters are set automatic for enable/disable state of Pr 6.10 “Function expansion setup” load variation suppression function automatic adjustment.

Class	No.	Attribute *1)	Title	Range	Unit	Function
6	10	B	Function expansion setup	-32768 – 32767	–	When set to Pr 6.10 bit14=1, load variation suppression function will become enabled (bit1 = 1). When set to Pr 6.10 bit14=0, it is disabled (bit1 = 0).
6	23	B	Disturbance torque compensating gain	-100–100	%	When set to Pr 6.10 bit14=1, sets to 90%. When set to Pr 6.10 bit14=0, sets to 0%.
6	24	B	Disturbance observer filter	10–2500	0.01 ms	When set to Pr 6.10 bit14=1, updates to match rigidity. When set to Pr 6.10 bit14=0, value is held.
6	73	B	Load estimation filter	0–2500	0.01 ms	When set to Pr 6.10 bit14=1, sets to 0.13 ms. When set to Pr 6.10 bit14=0, sets to 0 ms.
6	74	B	Torque compensation frequency 1	0–5000	0.1 Hz	Regardless value of the Pr 6.10 bit 14, sets to 0.
6	75	B	Torque compensation frequency 2	0–5000	0.1 Hz	Regardless value of the Pr 6.10 bit 14, sets to 0.
6	76	B	Load estimation count	0–8	-	When set to Pr 6.10 bit14=1, sets to 4. When set to Pr 6.10 bit14=0, sets to 0.

*1) For parameter attribute, refer to Section 9-1.

5) How to use

When Pr 0.02 (Setup of real-time auto-gain tuning mode) is set to a value other than 0, control parameter is automatically set according to Pr0.03 “Real-time auto-tuning machine stiffness setup” and Pr6.10 “Function expansion setup” bit14.

When the servo is ON, enter operation command after about 100ms. When the load characteristic is correctly estimated, Pr 0.04 "Inertia ratio" is updated. With certain mode settings, Pr 6.07 "Torque command addition value", Pr 6.08 "Positive direction compensation value", Pr6.09 "Negative direction torque compensation value", and Pr6.50 "Viscous friction compensating gain." will be changed.

When value of Pr0.03 “Real-time auto-tuning machine stiffness setup” is increased, the motor responsiveness will be improved. Determine the most appropriate stiffness in relation to the positioning setup time and vibration condition.

6) Other cautions

- [1] Strange noises or vibrations may occur on the first action of turning on the servo immediately after startup or setting higher value of Pr0.03 "Real-time auto-tuning machine stiffness setup" until estimation of load characteristic becomes stable. This is not a fault if the function becomes stable soon. If oscillation or continued generation of abnormal noise through three or more reciprocating movements often occurs, take the following steps.
- 1) Specify lower value for Pr0.03 "Real-time auto-tuning machine stiffness setup"
 - 2) Specify "0" for Pr0.02 "Real-time auto-gain tuning setup" and make real-time auto tuning invalid.
 - 3) Specify a theoretical value of device for Pr0.04 "Inertia ratio" and specify "0" for Pr6.07 "Torque command additional value", Pr6.08 "Positive direction torque compensation value", Pr6.09 "Negative direction torque compensation value" and Pr6.50 "Viscous friction compensating gain"
- [2] After occurrence of strange noises or vibrations, values of Pr0.04 "Inertia ratio", Pr6.07 "Torque command additional value", Pr6.08 "Positive direction torque compensation value", Pr6.09 "Negative direction torque compensation value", or Pr6.50 "Viscous friction compensating gain" may have been changed into extreme values. If this is the case, take Step 3) above.
- [3] The results of real-time automatic gain tuning, such as Pr0.04 "Inertia ratio," Pr6.07 "Torque command additional value", Pr6.08 "Positive direction torque compensation value", Pr6.09 "Negative direction torque compensation value", and Pr6.50 "Viscous friction compensating gain" are written in EEPROM in every 30 minutes. Upon restarting of power, auto tuning is performed using the data for initial values. The results of real-time auto gain tuning are not stored if the power is turned off before 30 minutes have elapsed. In this case, manually write the parameters to the EEPROM before turning off the power.
- [4] The control gain is updated when the motor is stopped. Therefore, if motor is not stopped because gain is excessively low or commands are given continually in one direction, the change in Pr0.03 "Real-time auto-tuning machine stiffness setup" may not be reflected. In this case, abnormal sound or oscillation may be generated depending on the stiffness setting that is reflected after the motor stops. After the stiffness setting is changed, be sure to stop the motor and check that the stiffness setting is reflected before performing next operation.
- [5] When real-time automatic tuning is valid in torque control under two-degrees-of-freedom control mode, it operates with Pr1.12=0 within the amplifier regardless of the setting value in Pr1.12 "Torque feed forward gain."
The state in which it operates with torque feed forward invalid will continue until the next operation is executed.
- Pr1.12 is set to a value other than the current parameter (1000) after real-time automatic tuning is switch.

7) Basic gain parameter settings table

Stiffness	1st gain / 2nd gain				Command response		Tuning filter	For load fluctuation suppression function
	Pr1.00 Pr1.05	Pr1.01 Pr1.06	Pr1.02 Pr1.07	Pr1.04 Pr1.09	Pr2.22		Pr6.48 *1	Pr6.24
	Position [0.1/s]	Speed [0.1 Hz]	Velocity integral [0.1 ms]	Torque [0.01 ms]	Time constant [0.1 ms]		Time constant [0.1 ms]	Load fluctuation compensation filter [0.01/ms]
Standard response mode					High response mode 1~3			
0	20	15	3700	1500	1919	764	155	2500
1	25	20	2800	1100	1487	595	115	2500
2	30	25	2200	900	1214	486	94	2500
3	40	30	1900	800	960	384	84	2500
4	45	35	1600	600	838	335	64	2500
5	55	45	1200	500	668	267	54	2500
6	75	60	900	400	496	198	44	2500
7	95	75	700	300	394	158	34	2120
8	115	90	600	300	327	131	34	1770
9	140	110	500	200	268	107	24	1450
10	175	140	400	200	212	85	23	1140
11	320	180	310	126	139	55	16	880
12	390	220	250	103	113	45	13	720
13	480	270	210	84	92	37	11	590
14	630	350	160	65	71	28	9	450
15	720	400	140	57	62	25	8	400
16	900	500	120	45	50	20	7	320
17	1080	600	110	38	41	17	6	270
18	1350	750	90	30	33	13	5	210
19	1620	900	80	25	28	11	5	180
20	2060	1150	70	20	22	9	4	140
21	2510	1400	60	16	18	7	4	110
22	3050	1700	50	13	15	6	3	90
23	3770	2100	40	11	12	5	3	80
24	4490	2500	40	9	10	4	3	60
25	5000	2800	35	8	9	4	2	60
26	5600	3100	30	7	8	3	2	50
27	6100	3400	30	7	7	3	2	50
28	6600	3700	25	6	7	3	2	40
29	7200	4000	25	6	6	2	2	40
30	8100	4500	20	5	6	2	2	40
31	9000	5000	20	5	5	2	2	40

*1 There is that Pr6.48 “Adjust filter” adds 1 to by a combination of driver and motor.

5-2 Manual adjusting function

As explained previously, MINAS-A6BL series features the automatic gain tuning function, however, there might be some cases where this automatic gain tuning cannot be adjusted properly depending on the limitation on load conditions. Or you might need to readjust the tuning to obtain the optimum response or stability corresponding to each load.

Here we explain this manual gain tuning method by each control mode and function.

- 1) Block diagram of position control mode (5-2-1)
- 2) Block diagram of velocity control mode (5-2-2)
- 3) Block diagram of torque control mode (5-2-3)
- 4) Gain switching function (5-2-4)
- 5) Notch filter (5-2-5)
- 6) Damping control (5-2-6)
- 7) Model type damping filter (5-2-7)
- 8) Feed forward function (5-2-8)
- 9) Load variation suppression function (5-2-9)
- 10) 3rd gain switching function (5-2-10)
- 11) Friction torque compensation (5-2-11)
- 12) Two-stage torque filter (5-2-12)
- 13) Quadrant projection suppression function (5-2-13)
- 14) Two-degree-of-freedom control mode (with position control) (5-2-14)
- 15) Two-degree-of-freedom control mode (with velocity control) (5-2-15)
- 16) Two-degree-of-freedom control mode (with torque control) (5-2-16)

5-2-1 Block diagram of position control mode

Position control of MINAS-A6BL series, there are four modes.

- Profile position mode (pp)
- Cyclic synchronous position mode (csp)
- Interpolated position mode (ip) (Not supported)
- Homing mode (hm)

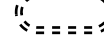
 Data of PANATERM
 Data of CiA402 object

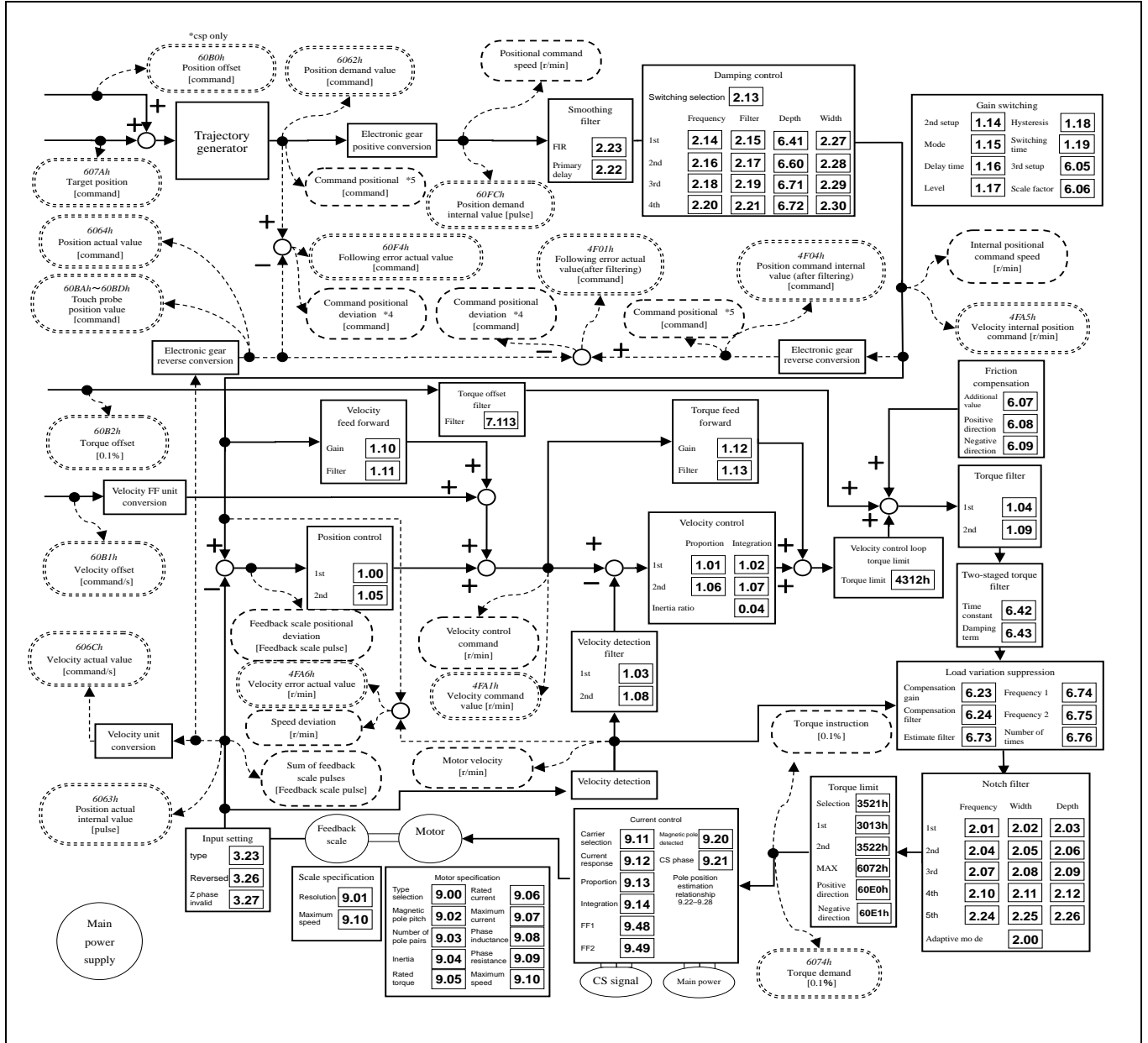



Block diagram of position control

- *1) A slanting number shows (ex: 607Ah) the object number of EtherCAT.
- *2) A bold letter number shows (ex: **1.00**) a parameter number.
- *3) Polarity was omitted.
- *4) The method to calculate the positional deviation on PANATERM and Analog monitor varies depending on the setting of bit14 (command positional deviation output change) of Pr7.23 (Communication function extended setup 2).
- *5) The position command on PANATERM can be switched depending on the setting of the bit3 (Command pulse accumulation value) of Pr7.99 (Communication function extended setup 6).
- *6) The amplifier will be switched internally to position control during execution of test run, frequency characteristics analysis (position loop characteristics) from PANATERM.
- *7) The first edition of the software version (Ver1.04) does not support 60E0h/60E1h (Positive/Negative torque limit value).

5-2-2 Block diagram of velocity control mode

Velocity control of MINAS-A6BL series, there are two modes.

- Profile velocity mode (pv)
- Cyclic synchronous velocity mode (csv)

 Data of PANATERM
 Data of CiA402 object

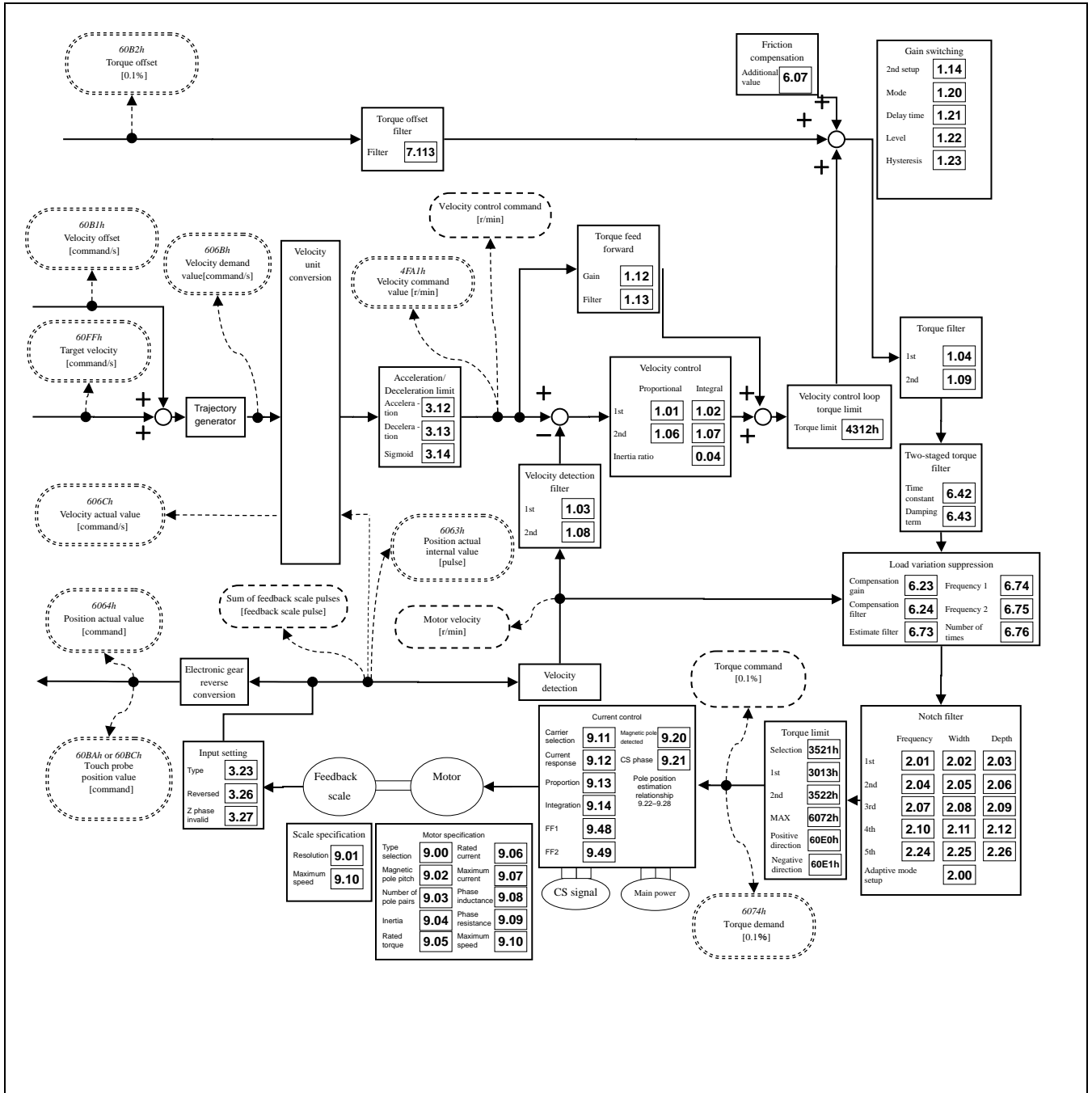

Block diagram of velocity control

- *1) A slanting number shows (ex: 607Ah) the object number of EtherCAT.
- *2) A bold letter number shows (ex: **1.00**) a parameter number.
- *3) Polarity was omitted.
- *4) When performing Frequency characteristic measurement (speed close loop characteristic, Torque speed(Vertical)) from the PANATERM, the driver switches to velocity control mode internally.
- *5) The first edition of the software version (Ver1.04) does not support 60E0h/60E1h (Positive/Negative torque limit value).

5-2-3 Block diagram of torque control mode

Telocity control of MINAS-A6BL series, there are two modes.

- Profile torque mode (tq)
- Cyclic synchronous torque mode (cst)

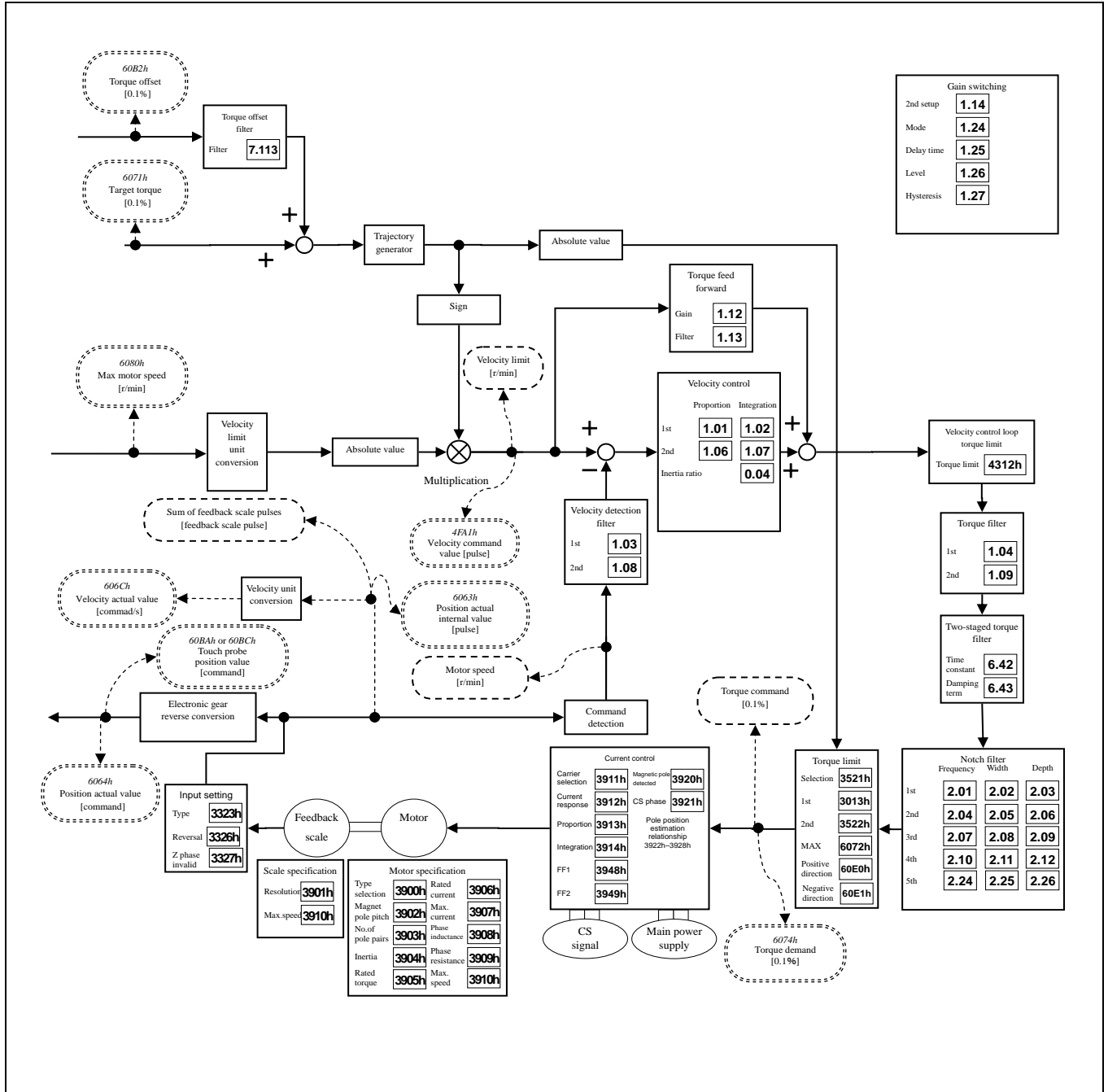
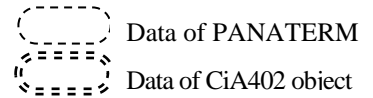

Block diagram of torque control

- *1) A slanting number shows (ex: 607Ah) the object number of EtherCAT.
- *2) A bold letter number shows (ex:1.00) a parameter number.
- *3) Polarity was omitted.
- *4) When performing Frequency characteristic measurement (Torque speed (normal)) from the PANATERM, the driver switches to torque control mode internally.
- *5) Torque control under two-degree-of-freedom control mode is executed in a similar fashion to the torque control under the conventional control mode.
- *6) The first edition of the software version (Ver1.04) does not support 60E0h/60E1h (Positive/Negative torque limit value).

5-2-4 Gain Switching Function

By selecting appropriate gain based on internal data or external signal, the following effects can be obtained.

- Decrease the gain at the time of stoppage (servo lock) to reduce vibration.
- Increase the gain at the time of stoppage (setting) to shorten the settling time.
- Increase the gain during operation to improve command compliance.
- Based on condition of the equipment, change the gain with external signal.

1) Relevant parameters

Set the gain switching function using the following parameters.

Class	No.	Attribute *1)	Title	Range	Unit	Function																								
1	14	B	2nd gain setup	0–1	—	Arrange this parameter when performing optimum adjustment by using the gain switching function. 0: It is fixed to the 1st gain. 1: Enable gain switching of 1st gain (Pr 1.00–Pr 1.04) and 2nd gain (Pr 1.05–Pr 1.09).																								
1	15	B	Mode of position control switching	0–10	—	Set up the triggering condition of gain switching for position control. <table border="1"> <thead> <tr> <th>Setup value</th> <th>Switching condition</th> </tr> </thead> <tbody> <tr> <td>0</td> <td>Fixed to 1st gain</td> </tr> <tr> <td>1</td> <td>Fixed to 2nd gain</td> </tr> <tr> <td>2</td> <td>For manufacturer's use</td> </tr> <tr> <td>3</td> <td>Torque command</td> </tr> <tr> <td>4</td> <td>Invalid (Fixed to 1st gain)</td> </tr> <tr> <td>5</td> <td>Velocity command</td> </tr> <tr> <td>6</td> <td>Position deviation</td> </tr> <tr> <td>7</td> <td>Position command exists</td> </tr> <tr> <td>8</td> <td>Not in positioning complete</td> </tr> <tr> <td>9</td> <td>Actual speed</td> </tr> <tr> <td>10</td> <td>Position command exists + Actual speed</td> </tr> </tbody> </table>	Setup value	Switching condition	0	Fixed to 1st gain	1	Fixed to 2nd gain	2	For manufacturer's use	3	Torque command	4	Invalid (Fixed to 1st gain)	5	Velocity command	6	Position deviation	7	Position command exists	8	Not in positioning complete	9	Actual speed	10	Position command exists + Actual speed
Setup value	Switching condition																													
0	Fixed to 1st gain																													
1	Fixed to 2nd gain																													
2	For manufacturer's use																													
3	Torque command																													
4	Invalid (Fixed to 1st gain)																													
5	Velocity command																													
6	Position deviation																													
7	Position command exists																													
8	Not in positioning complete																													
9	Actual speed																													
10	Position command exists + Actual speed																													
1	16	B	Delay time of position control switching	0–10000	0.1 ms	For position controlling: When shifting from the 2nd gain to the 1st gain with Pr 1.15 Position control gain switching mode set at 3, 5, 6, 7, 8, 9 or 10, set up the delay time from trigger detection to the switching operation.																								
1	17	B	Level of position control switching	0–20000	Mode dependent	For position controlling: Set up triggering level when Pr 1.15 "Position control gain switching mode" is set at 3, 5, 6, 9 or 10. Unit of setting varies with switching mode. Note: Set the level equal to or higher than the hysteresis.																								
1	18	B	Hysteresis at position control switching	0–20000	Mode dependent	For position controlling: Set up triggering hysteresis when Pr 1.15 "Position control gain switching mode" is set at 3, 5, 6, 9 or 10. Unit of setting varies with switching mode. Note: When level < hysteresis, the hysteresis is internally adjusted so that it is equal to level.																								
1	19	B	Position gain switching time	0–10000	0.1 ms	For position controlling: If the difference between Pr 1.00 "1st gain of position loop" and Pr 1.05 "2nd gain of poison loop" is large, the increasing rate of position loop gain can be limited by this parameter. The position loop gain will increase over the time set.																								

(To be continued)

Class	No.	Attribute *1)	Title	Range	Unit	Function														
1	20	B	Mode of velocity control switching	0-5	—	For velocity controlling: Set the condition to trigger gain switching. <table border="1"> <thead> <tr> <th>Setup value</th> <th>Switching condition</th> </tr> </thead> <tbody> <tr> <td>0</td> <td>Fixed to 1st gain</td> </tr> <tr> <td>1</td> <td>Fixed to 2nd gain</td> </tr> <tr> <td>2</td> <td>For manufacturer's use</td> </tr> <tr> <td>3</td> <td>Torque command</td> </tr> <tr> <td>4</td> <td>Velocity command variation is larger.</td> </tr> <tr> <td>5</td> <td>Velocity command</td> </tr> </tbody> </table>	Setup value	Switching condition	0	Fixed to 1st gain	1	Fixed to 2nd gain	2	For manufacturer's use	3	Torque command	4	Velocity command variation is larger.	5	Velocity command
Setup value	Switching condition																			
0	Fixed to 1st gain																			
1	Fixed to 2nd gain																			
2	For manufacturer's use																			
3	Torque command																			
4	Velocity command variation is larger.																			
5	Velocity command																			
1	21	B	Delay time of velocity control switching	0-10000	0.1 ms	For velocity controlling: When shifting from the 2nd gain to the 1st gain with Pr 1.20 "Velocity control switching mode" set at 3, 4 or 5, set the delay time from trigger detection to the switching operation.														
1	22	B	Level of velocity control switching	0-20000	Mode dependent	For velocity controlling: Set up triggering level when Pr 1.20 Velocity control gain switching mode is set at 3, 4 or 5. Unit of setting varies with switching mode. Note: Set the level equal to or higher than the hysteresis.														
1	23	B	Hysteresis at velocity control switching	0-20000	Mode dependent	For velocity controlling: Set up triggering hysteresis when Pr 1.20 "Velocity control gain switching mode" is set at 3, 4 or 5. Unit of setting varies with switching mode. Note: When level < hysteresis, the hysteresis is internally adjusted so that it is equal to level.														
1	24	B	Mode of torque control switching	0-3	—	For torque controlling: Set the condition to trigger gain switching <table border="1"> <thead> <tr> <th>Setup value</th> <th>Switching condition</th> </tr> </thead> <tbody> <tr> <td>0</td> <td>Fixed to 1st gain</td> </tr> <tr> <td>1</td> <td>Fixed to 2nd gain</td> </tr> <tr> <td>2</td> <td>For manufacturer's use</td> </tr> <tr> <td>3</td> <td>Torque command</td> </tr> </tbody> </table>	Setup value	Switching condition	0	Fixed to 1st gain	1	Fixed to 2nd gain	2	For manufacturer's use	3	Torque command				
Setup value	Switching condition																			
0	Fixed to 1st gain																			
1	Fixed to 2nd gain																			
2	For manufacturer's use																			
3	Torque command																			
1	25	B	Delay time of torque control switching	0-10000	0.1 ms	For torque controlling: When shifting from the 2nd gain to the 1st gain with Pr 1.24 "Torque control switching mode" set at 3, set up the delay time from trigger detection to the switching operation.														
1	26	B	Level of torque control switching	0-20000	Mode dependent	For torque controlling: Set up triggering level when Pr 1.24 Torque control gain switching mode is set at 3. Unit varies depending on the setup of mode of control switching. Note: Set the level equal to or higher than the hysteresis.														
1	27	B	Hysteresis at torque control switching	0-20000	Mode dependent	For torque controlling: Set up triggering hysteresis when Pr 1.24 Torque control gain switching mode is set at 3. Unit of setting varies with switching mode. Note: When level < hysteresis, the hysteresis is internally adjusted so that it is equal to level.														

*1) For parameter attribute, refer to Section 9-1.

2) How to use

Set the gain switching mode for the control mode to be used, and enable the gain switching function through Pr 1.14 2nd gain setup (set Pr 1.14 to 1).

Switching mode (Pr1.15) Setup value	Switching condition	Gain switching condition
0	Fixed to 1st gain	Fixed to the 1st gain (Pr 1.00 to Pr 1.04).
1	Fixed to 2nd gain	Fixed to the 2nd gain (Pr 1.05 to Pr 1.09).
2	For manufacturer's use	Please do not set.
3	Torque command is large	<ul style="list-style-type: none"> • Shift to the 2nd gain when the absolute value of the torque command exceeded (level + hysteresis) (%) previously with the 1st gain. • Return to the 1st gain when the absolute value of the torque command was kept below (level-hysteresis) (%) previously during delay time with the 2nd gain.
4	Velocity command variation is larger.	<ul style="list-style-type: none"> • Valid only during velocity control. • Shift to the 2nd gain when the absolute value of the velocity command variations exceeded (level + hysteresis) (10 r/min/s) previously with the 1st gain. • Return to the 1st gain when the absolute value of the velocity command variations was kept below (level-hysteresis) (10 r/min/s) during delay time previously with the 2nd gain. <p>* The 1st gain is fixed while the velocity control is not applied.</p>
5	Velocity command is large	<ul style="list-style-type: none"> • Valid for position and velocity controls. • Shift to the 2nd gain when the absolute value of the velocity command exceeded (level +hysteresis) (r/min) previously with the 1st gain. • Return to the 1st gain when the absolute value of the velocity command was kept below (level- hysteresis) (r/min) previously during delay time with the 2nd gain.
6	Position deviation is large	<ul style="list-style-type: none"> • Valid only during position control. • Shift to the 2nd gain when the absolute value of the positional deviation exceeded (level +hysteresis) (pulse) previously with the 1st gain. • Return to the 1st gain when the absolute value of the positional deviation was kept below (level-hysteresis) (pulse) previously over delay time with the 2nd gain. <p>* Unit of level and hysteresis (pulse) is set as the feedback scale resolution.</p> <p>* The positional deviation in these contents indicates the deviation between the internal command position and actual position after the filter regardless of the set value of Pr7.23: bit 14.</p>

(To be continued)

Switching mode (Pr1.15) Setup value	Switching condition	Gain switching condition
7	Position command exists	<ul style="list-style-type: none"> Valid only during position control. Shift to the 2nd gain when the positional command was not 0 previously with the 1st gain. Return to the 1st gain when the positional command was kept 0 previously during delay time with the 2nd gain.
8	Not in positioning complete	<ul style="list-style-type: none"> Valid only during position control. Shift to the 2nd gain when the positioning was not completed previously with the 1st gain. Return to the 1st gain when the positioning was kept in completed condition previously during delay time with the 2nd gain.
9	Actual speed is large	<ul style="list-style-type: none"> Valid only during position control. Shift to the 2nd gain when the absolute value of the actual speed exceeded (level + hysteresis) (r/min) previously with the 1st gain. Return to the 1st gain when the absolute value of the actual speed was kept below (level -hysteresis) (r/min) previously during delay time with the 2nd gain.
10	Position command exists + Actual speed	<ul style="list-style-type: none"> Valid only during position control. Shift to the 2nd gain when the positional command was not 0 previously with the 1st gain. Return to the 1st gain when the positional command was kept at 0 during the delay time and the absolute value of actual speed was kept below (level-hysteresis) (r/min) previously with the 2nd gain.

3) How to set

Suppose the load travels from A to B position and the internal status of the drive changes as the fig. below shows. Hereunder we explain how to set up the related parameters when you use the gain switching function.

- 1) Set up the conditions for gain switching with the following parameters.
 - Pr 1.15 "Mode of position control switching"
 - Pr 1.20 "Mode of velocity control switching"
 - Pr 1.24 "Mode of torque control switching"

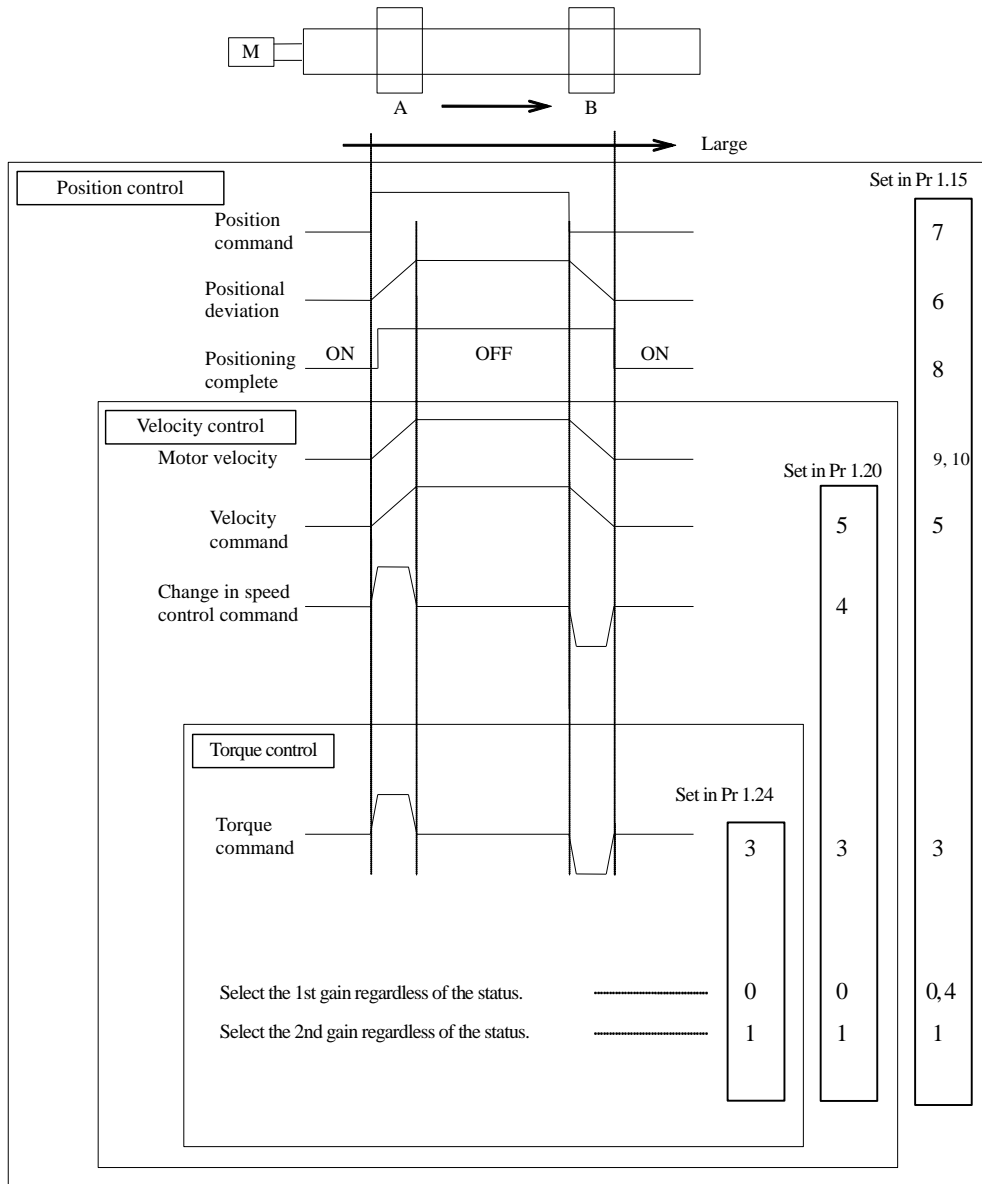

2) Set up the switching level and Hysteresis depending on the switching conditions.

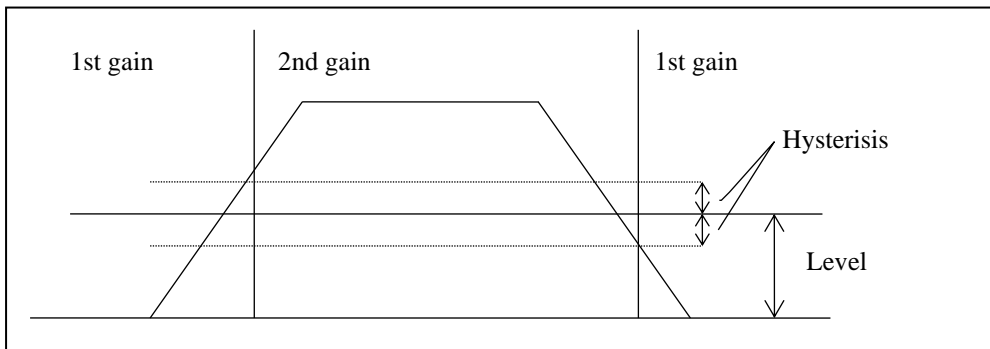

3) Set up the switching delay time.

Set up the time delay for switching from 2nd gain to 1st gain.

Switching conditions have to be established continuously during the switching delay time for the switching from the 2nd to the 1st.

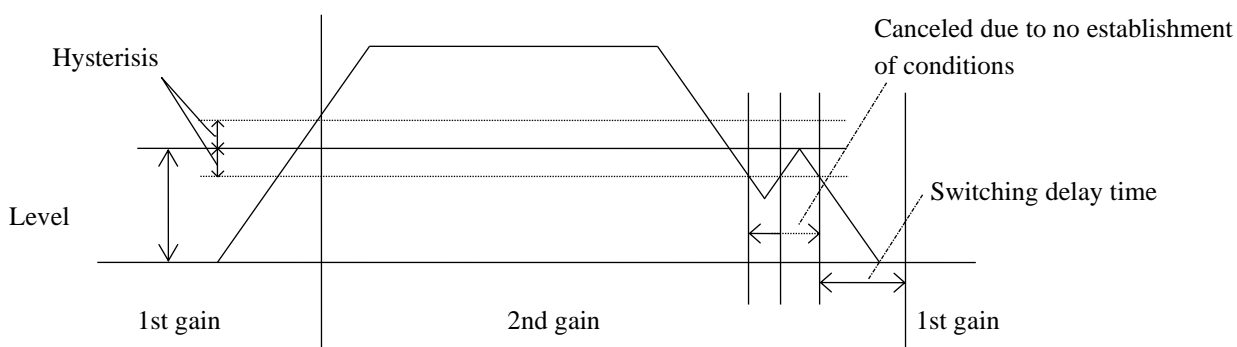

4) Set up the switching time of position gain.

Switch the position loop gain gradually to avoid any trouble caused by a rapid change to a higher gain, while the velocity loop gain, time constant of velocity loop integration, velocity detection filter and time constant of torque filter can be switched instantaneously.

*The gain switching flag changes immediately when switching from low gain.

When Pr 1.19 (Position loop gain switching time) is 0,

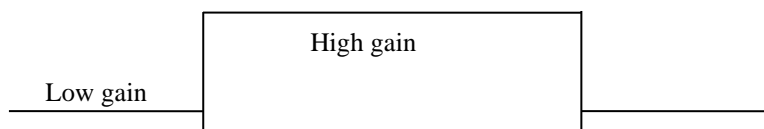

When Pr 1.19 (Position loop gain switching time) is 2,

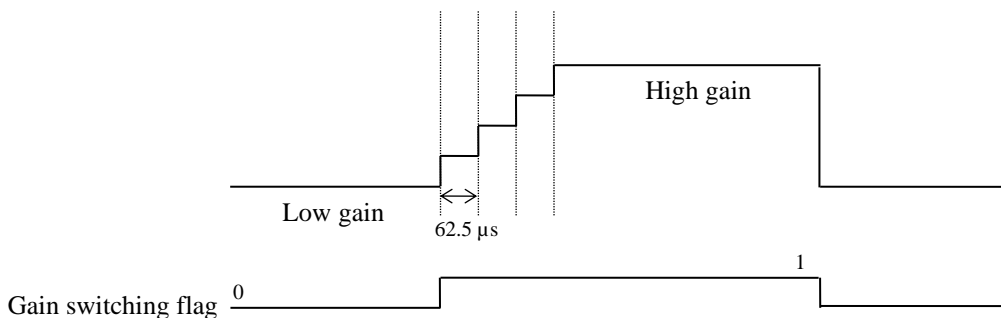

5-2-5 Notch filter

In case of low machine stiffness, you cannot set up a higher gain because vibration and noise occur due to oscillation caused by axis distortion or other causes. By suppressing the resonance peak at the notch filter, higher gain can be obtained or the level of vibration can be lowered.

1) Relevant parameters

MINAS-A6BL series feature 5 normal notch filters. You can adjust frequency and width and depth.

Class	No.	Attribute *1)	Title	Range	Unit	Function
2	01	B	1st notch frequency	50-5000	Hz	Set the center frequency of the 1st notch filter. The notch filter function will be invalidated by setting up this parameter to "5000".
2	02	B	1st notch width selection	0-20	—	Set the width of notch at the center frequency of the 1st notch filter.
2	03	B	1st notch depth selection	0-99	—	Set the depth of notch at the center frequency of the 1st notch filter.
2	04	B	2nd notch frequency	50-5000	Hz	Set the center frequency of the 2nd notch filter. The notch filter function will be invalidated by setting up this parameter to "5000".
2	05	B	2nd notch width selection	0-20	—	Set the width of notch at the center frequency of the 2nd notch filter.
2	06	B	2nd notch depth selection	0-99	—	Set the depth of notch at the center frequency of the 2nd notch filter.
2	07	B	3rd notch frequency *2)	50-5000	Hz	Set the center frequency of the 3rd notch filter. The notch filter function will be invalidated by setting up this parameter to "5000".
2	08	B	3rd notch width selection *2)	0-20	—	Set the width of notch at the center frequency of the 3rd notch filter.
2	09	B	3rd notch depth selection *2)	0-99	—	Set the depth of notch at the center frequency of the 3rd notch filter.
2	10	B	4th notch frequency *2)	50-5000	Hz	Set the center frequency of the 4th notch filter. The notch filter function will be invalidated by setting up this parameter to "5000".
2	11	B	4th notch width selection *2)	0-20	—	Set the width of notch at the center frequency of the 4th notch filter.
2	12	B	4th notch depth selection *2)	0-99	—	Set the depth of notch at the center frequency of the 4th notch filter.
2	24	B	5th notch frequency	50-5000	Hz	Set the center frequency of the 5th notch filter. The notch filter function will be invalidated by setting up this parameter to "5000".
2	25	B	5th notch width selection	0-20	—	Set the width of notch at the center frequency of the 5th notch filter.
2	26	B	5th notch depth selection	0-99	—	Set the depth of notch at the center frequency of the 5th notch filter.

*1) For parameter attribute, refer to Section 9-1.

*2) When the applicable filtering function is used, parameter value is automatically set.

2) How to use

Determine the resonant frequency by using the frequency response measurement function of the setup support software, resonant frequency monitor or waveform graphics function and set it to the notch frequency.

3) Notch width and depth

The width of the notch filter is the ratio of the width of -3 dB attenuation frequency band with respect to the notch frequency at its center when depth is 0, and the value is as shown in the table below.

The notch filter depth indicates I/O ratio where the input at the center frequency is completely shut with setup value 0 but fully received with setup value 100. The table below shows this value in dB on the right.

Notch width	Band width/center frequency
0	0.25
1	0.30
2	0.35
3	0.42
4	0.50
5	0.59
6	0.71
7	0.84
8	1.00
9	1.19
10	1.41
11	1.68
12	2.00
13	2.38
14	2.83
15	3.36
16	4.00
17	4.76
18	5.66
19	6.73
20	8.00

Notch depth	I/O ratio	[dB]
0	0.00	$-\infty$
1	0.01	-40.0
2	0.02	-34.0
3	0.03	-30.5
4	0.04	-28.0
5	0.05	-26.0
6	0.06	-24.4
7	0.07	-23.1
8	0.08	-21.9
9	0.09	-20.9
10	0.10	-20.0
15	0.15	-16.5
20	0.20	-14.0
25	0.25	-12.0
30	0.30	-10.5
35	0.35	-9.1
40	0.40	-8.0
45	0.45	-6.9
50	0.50	-6.0
60	0.60	-4.4
70	0.70	-3.1
80	0.80	-1.9
90	0.90	-0.9
100	1.00	0.0

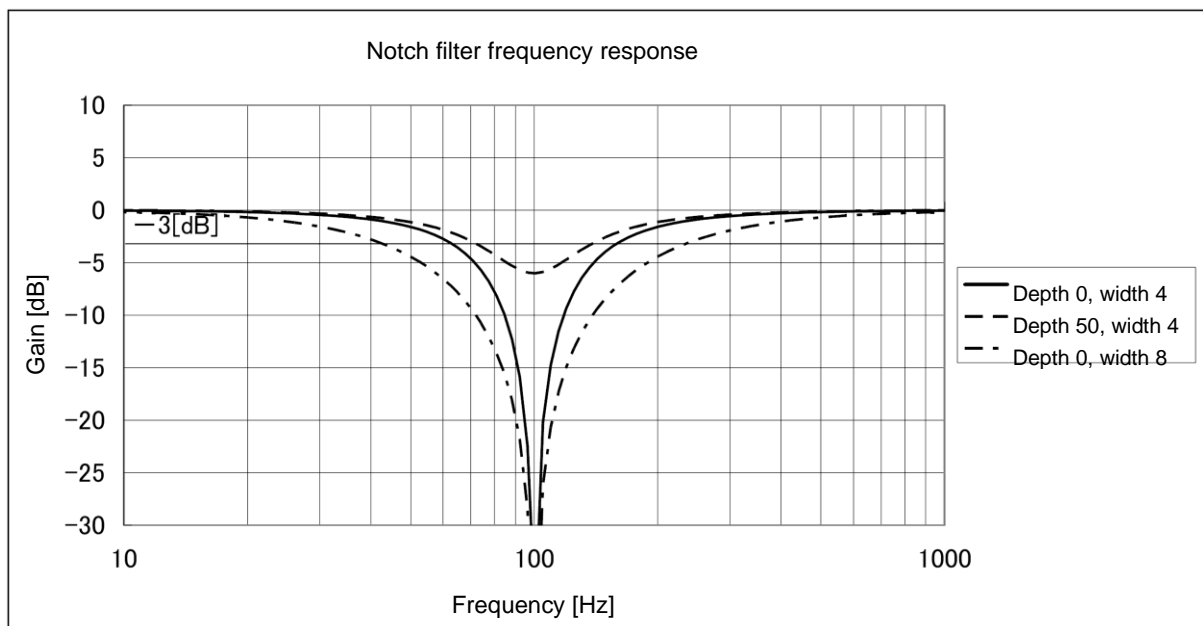

5-2-6 Damping Control

This function reduces the vibration at the top or on whole of the equipment by removing the vibration frequency components specified by the positional command. Up to 3 frequency settings, out of 4 settings in total, can be used simultaneously.

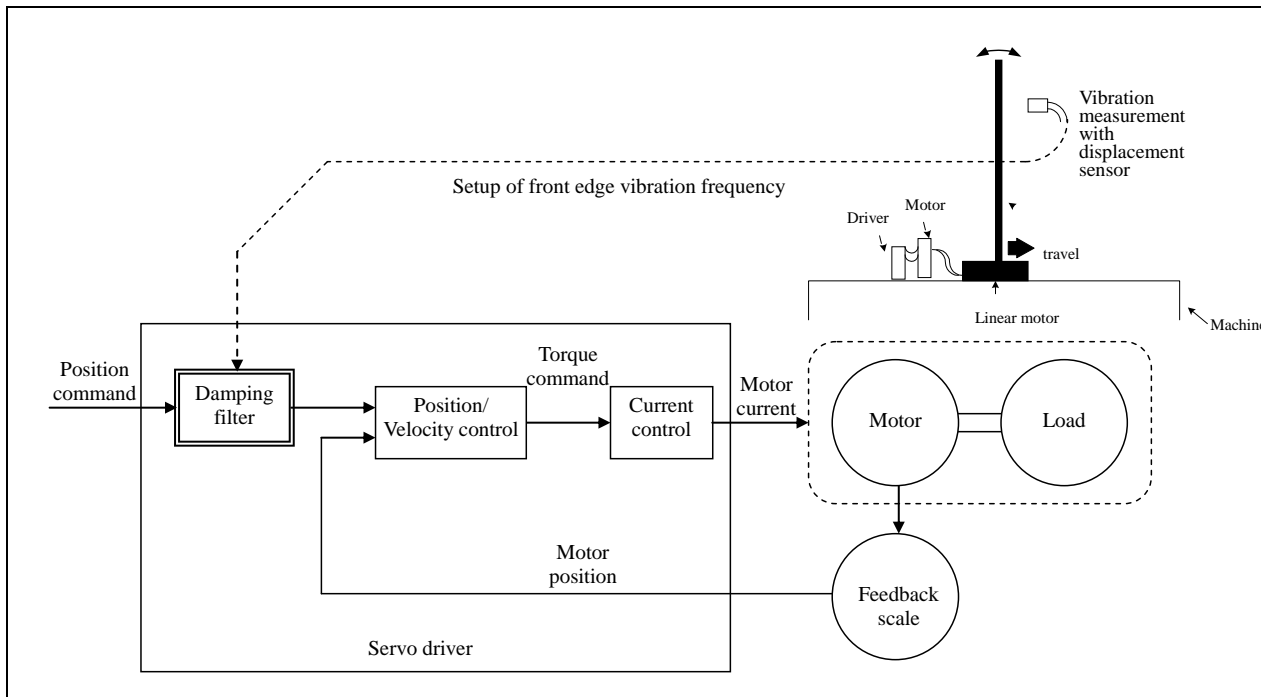

1) Applicable Range

Damping control is activated under the following conditions.

Conditions under which the damping control is activated	
Control mode	Position control mode.

2) Caution

This function does not work properly or no effect is obtained under the following conditions.

Conditions which obstruct the damping control effect	
Load	<ul style="list-style-type: none"> • Vibration is triggered by other factors than command (such as disturbance). • Ratio of resonance frequency and anti-resonance frequency is large. • Vibration frequency is out of the range of 0.5–300.0 [Hz].

3) Relevant parameters

Set up damping control operation using the parameters shown below.

Class	No.	Attribute *1)	Title	Range	Unit	Function																																																														
2	13	B	Selection of damping filter switching	0-6	—	<p>Among 4 filters select the filters to be used for damping control.</p> <ul style="list-style-type: none"> • When setup value is 0: Up to 2 filters can be used simultaneously. • When setup value is 1 or 2: Reserved for manufacturer's use (do not set this) • With setup value 3: Select the filter with command direction. <table border="1"> <thead> <tr> <th>Pr. 2.13</th> <th>Position command direction</th> <th>1st damping</th> <th>2nd damping</th> <th>3rd damping</th> <th>4th damping</th> </tr> </thead> <tbody> <tr> <td rowspan="2">3</td> <td>Positive direction</td> <td>Enabled</td> <td>Disabled</td> <td>Enabled</td> <td>Disabled</td> </tr> <tr> <td>Negative direction</td> <td>Disabled</td> <td>Enabled</td> <td>Disabled</td> <td>Enabled</td> </tr> </tbody> </table> <p>Contents of setup values 4 to 6 will differ with enabled/disabled switching of two-degree-of-freedom control mode.</p> <ul style="list-style-type: none"> • Position control (Two-degree-of-freedom control mode disabled) <table border="1"> <thead> <tr> <th>Pr. 2.13</th> <th>1st damping</th> <th>2nd damping</th> <th>3rd damping</th> <th>4th damping</th> </tr> </thead> <tbody> <tr> <td>4</td> <td>Enabled</td> <td>Enabled</td> <td>Enabled</td> <td>Disabled</td> </tr> <tr> <td>5, 6</td> <td colspan="4">Same as with setup value 0</td> </tr> </tbody> </table> <ul style="list-style-type: none"> • Position control (Two-degree-of-freedom control mode enabled) <table border="1"> <thead> <tr> <th>Pr. 2.13</th> <th>1st model-type damping</th> <th>2nd model-type damping</th> </tr> </thead> <tbody> <tr> <td>4</td> <td>Enabled</td> <td>Enabled</td> </tr> <tr> <td>5</td> <td colspan="2">For manufacturer's use (do not set this)</td> </tr> </tbody> </table> <table border="1"> <thead> <tr> <th>Pr. 2.13</th> <th>Position command direction</th> <th>1st model-type damping</th> <th>2nd model-type damping</th> </tr> </thead> <tbody> <tr> <td rowspan="2">6</td> <td>Positive direction</td> <td>Enabled</td> <td>Disabled</td> </tr> <tr> <td>Negative direction</td> <td>Disabled</td> <td>Enabled</td> </tr> </tbody> </table> <ul style="list-style-type: none"> • Full-closed control <table border="1"> <thead> <tr> <th>Pr. 2.13</th> <th>1st damping</th> <th>2nd damping</th> <th>3rd damping</th> <th>4th damping</th> </tr> </thead> <tbody> <tr> <td>4-6</td> <td colspan="4">Same as with setup value 0</td> </tr> </tbody> </table>	Pr. 2.13	Position command direction	1st damping	2nd damping	3rd damping	4th damping	3	Positive direction	Enabled	Disabled	Enabled	Disabled	Negative direction	Disabled	Enabled	Disabled	Enabled	Pr. 2.13	1st damping	2nd damping	3rd damping	4th damping	4	Enabled	Enabled	Enabled	Disabled	5, 6	Same as with setup value 0				Pr. 2.13	1st model-type damping	2nd model-type damping	4	Enabled	Enabled	5	For manufacturer's use (do not set this)		Pr. 2.13	Position command direction	1st model-type damping	2nd model-type damping	6	Positive direction	Enabled	Disabled	Negative direction	Disabled	Enabled	Pr. 2.13	1st damping	2nd damping	3rd damping	4th damping	4-6	Same as with setup value 0			
Pr. 2.13	Position command direction	1st damping	2nd damping	3rd damping	4th damping																																																															
3	Positive direction	Enabled	Disabled	Enabled	Disabled																																																															
	Negative direction	Disabled	Enabled	Disabled	Enabled																																																															
Pr. 2.13	1st damping	2nd damping	3rd damping	4th damping																																																																
4	Enabled	Enabled	Enabled	Disabled																																																																
5, 6	Same as with setup value 0																																																																			
Pr. 2.13	1st model-type damping	2nd model-type damping																																																																		
4	Enabled	Enabled																																																																		
5	For manufacturer's use (do not set this)																																																																			
Pr. 2.13	Position command direction	1st model-type damping	2nd model-type damping																																																																	
6	Positive direction	Enabled	Disabled																																																																	
	Negative direction	Disabled	Enabled																																																																	
Pr. 2.13	1st damping	2nd damping	3rd damping	4th damping																																																																
4-6	Same as with setup value 0																																																																			

(To be continued)

*1 Switching between the damping frequency and damping filter setting is performed at the rising edge of the command that causes the number of command pluses per command detection period (0.125 ms) (at upstream of position command filter) changes from 0 to any other value while the positioning complete is being output.

Even if the control mode is changed to position control after changing the damping frequency and damping filter settings during velocity control or torque control, the setting is not changed.

Especially, at higher damping frequency, or if it becomes disabled, and wider positioning complete range is set up, and if large pulse (area is equivalent of time integration of the value of position command at upstream of the filter minus the value of position command at downstream of filter) remains in the filter during switching, it is rapidly discharged upon switching and returns to original position, and the motor will move at a speed higher than normal command velocity.

*2 There is delay from setting change of damping frequency or damping filter to internal computation and application of new setting values. If the switching described in *1 occurs during this delay time, application of new value will be suspended.

Class	No.	Attribute *1)	Title	Range	Unit	Function
2	14	B	1st damping frequency	0–3000	0.1 Hz	You can set up the 1st damping frequency of the damping control which suppresses vibration at the load edge. The driver measures vibration at load edge. Setup unit is 0.1 [Hz] The setup frequency is 0.5 to 300.0 [Hz]. Setup of 0 to 4 becomes invalid.
2	15	B	1st damping filter setup	0–1500	0.1 Hz	If torque saturation occurs with damping frequency 1st enabled, decrease the setup value, or if the operation is slow, increase it. Usually set it to 0. Note: The maximum setup value is internally limited to the corresponding damping frequency or 3000–damping frequency, whichever is smaller.
6	41	B	1st damping depth	0–1000	—	Specifies a depth corresponding to the 1st damping frequency. The depth is maximum if the setting value is 0. As the setting value increases, the depth decreases. As the depth increases, the damping effect increases, but the delay also increases. As the depth decreases, the delay decreases, but the damping effect also decreases. Use the parameter to fine adjust the damping effect and delay.
2	27	A	1st damping width setting	0–1000	-	Sets the width for the 1st damping frequency. The enabled range of setup is between 10 to 1000 and will operate as set to 100 between the range of 0 to 9. Within the setup range, the width will increase with the increase in the setup value, increasing robustness against vibration fluctuation.
2	16	B	2nd damping frequency	0–3000	0.1 Hz	You can set up the 2nd damping frequency of the damping control which suppresses vibration at the load edge. The driver measures vibration at load edge. Setup unit is 0.1 [Hz]. The setup frequency is 0.5 to 300.0 [Hz]. Setup of 0 to 4 becomes invalid.
2	17	B	2nd damping filter setup	0–1500	0.1 Hz	If torque saturation occurs with damping frequency 2nd enabled, decrease the setup value, or if the operation is slow, increase it. Usually set it to 0. Note: The maximum setup value is internally limited to the corresponding damping frequency or 3000–damping frequency, whichever is smaller.
6	60	A	2nd damping depth	0–1000	-	Defines the depth against the 2nd damping frequency. The depth becomes maximum when the setup value is 0. The larger the setup value, the smaller the depth. Although the damping effect increases as the depth becomes larger, the delay becomes large. While the delay decreases as the depth becomes smaller, the damping effect decreases. Use this parameter to fine tune the damping effect and delay.
2	28	A	2nd damping width setting	0–1000	-	Sets the width for the 2nd damping frequency. The enabled range of setup is between 10 to 1000 and will operate as set to 100 between the range of 0 to 9. Within the setup range, the width will increase with the increase in the setup value, increasing robustness against vibration fluctuation.
2	18	B	3rd damping frequency	0–3000	0.1 Hz	You can set up the 3rd damping frequency of the damping control which suppresses vibration at the load edge. The driver measures vibration at load edge. Setup unit is 0.1 [Hz] The setup frequency is 0.5 to 300.0 [Hz]. Setup of 0 to 4 becomes invalid.
2	19	B	3rd damping filter setup	0–1500	0.1 Hz	If torque saturation occurs with damping frequency 3rd enabled, decrease the setup value, or if the operation is slow, increase it. Usually set it to 0. Note: The maximum setup value is internally limited to the corresponding damping frequency or 3000–damping frequency, whichever is smaller.
6	71	A	3rd damping depth	0–1000	-	Defines the depth against the 3rd damping frequency. The depth becomes maximum if the setup value is 0. The larger the setup value, the smaller the depth. Although the damping effect increases as the depth becomes larger, the delay becomes large. While the delay decreases as the depth becomes smaller, the damping effect decreases. Use this parameter to fine tune the damping effect and delay.
2	29	A	3rd damping width setting	0–1000	-	Sets the width for the 3rd damping frequency. The enabled range of setup is between 10 to 1000 and will operate as set to 100 between the range of 0 to 9. Within the setup range, the width will increase with the increase in the setup value, increasing robustness against vibration fluctuation.
2	20	B	4th damping frequency	0–3000	0.1 Hz	You can set up the 4th damping frequency of the damping control which suppresses vibration at the load edge. The driver measures vibration at load edge. Setup unit is 0.1 [Hz] The setup frequency is 0.5 to 300.0 [Hz]. Setup of 0 to 4 becomes invalid.
2	21	B	4th damping filter setup	0–1500	0.1 Hz	If torque saturation occurs with damping frequency 4th enabled, decrease the setup value, or if the operation is slow, increase it. Usually set it to 0. Note: The maximum setup value is internally limited to the corresponding damping frequency or 3000–damping frequency, whichever is smaller.

(To be continued)

Class	No.	Attribute *1)	Title	Range	Unit	Function
6	72	B	4th damping depth	0-1000	-	Defines the depth against the 4th damping frequency. The depth becomes maximum if the setup value is 0. The larger the setup value, the smaller the depth. Although the damping effect increases as the depth becomes larger, the delay becomes large. While the delay decreases as the depth becomes smaller, the damping effect decreases. Use this parameter to fine tune the damping effect and delay.
2	30	B	4th damping width setting	0-1000	-	Sets the width for the 4th damping frequency. The enabled range of setup is between 10 to 1000 and will operate as set to 100 between the range of 0 to 9. Within the setup range, the width will increase with the increase in the setup value, increasing robustness against vibration fluctuation.

*1) For parameter attribute, refer to Section 9-1.

4) How to use

(1) Setup of damping frequency (1st: Pr 2.14, 2nd: Pr 2.16, 3rd: Pr 2.18, 4th: Pr 2.20)

Measure the vibration frequency of the front edge of the machine. When you use such instrument as laser displacement meter, and can directly measure the load end vibration, read out the vibration frequency by 0.1 [Hz] from the measured waveform and enter it.

If suitable measuring device is not available, measure the frequency according to the residual vibration of the position deviation waveform measured by the vibration frequency monitor of the setup support software or a waveform graphic function.

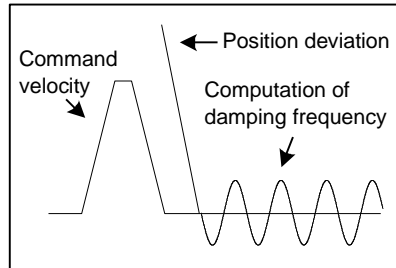

(2) Setup of damping filter (1st: Pr 2.15, 2nd: Pr 2.17, 3rd: Pr 2.19, 4th: Pr 2.21)

First, set to 0 and check the torque waveform during operation.

You can reduce the settling time by setting up larger value, however, the torque ripple increases at the command changing point as the right fig. shows. Setup within the range where no torque saturation occurs under the actual condition. If torque saturation occurs, damping control effect will be lost.

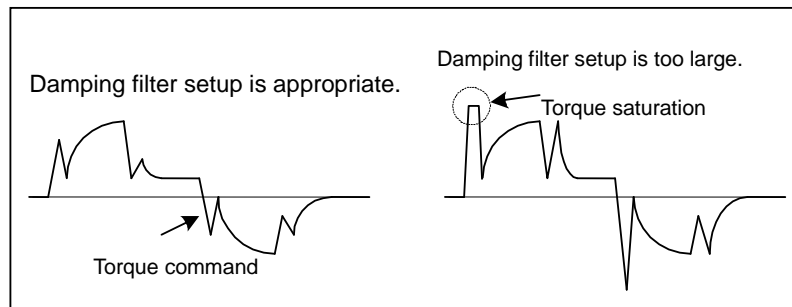

(3) Setup of damping depth (Pr 6.41, Pr 6.60, Pr 6.71, Pr 6.72)

Setup of damping width (Pr 2.27, Pr 2.28, Pr 2.29, Pr 2.30)

First set it to 0, and increase the setting value little by little if settling time needs to be decreased. As the setting value increases, the settling time can be decreased, but the damping effect is also decreased. Make an adjustment while checking the statuses of the settling time and vibration.

5-2-7 Model-type damping filter

This function reduces vibration at the edge or over the entire equipment by removing the vibration frequency components specified by the positional command.

The model-type damping filter can also remove resonance frequency components as well as anti-resonance frequency components, enhancing the effect of a conventional damping filter to generate smooth torque commands and offering a better damping effect.

In addition, the removal of anti-resonance frequency components and resonance frequency components can increase the responsiveness of the command response filter, which improves the settling time.

However, unlike a conventional damping filter, the model-type damping filter cannot obtain vibration components from the position sensor for the measurement of anti-resonance frequency components and resonance frequency components, which thus requires frequency characteristics analysis and the setting of optimum parameter values.

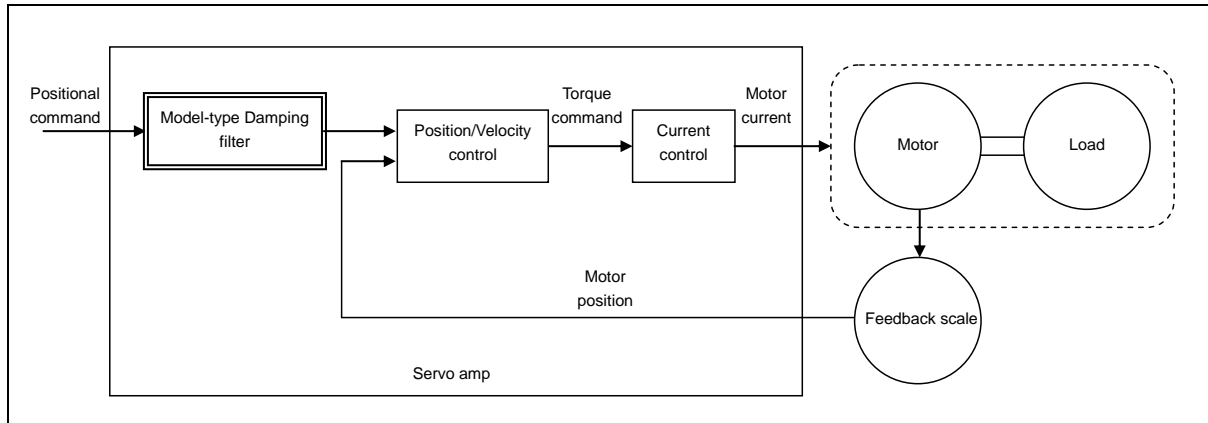

1) Applicable Range

The model-type damping filter is activated under the following conditions.

Conditions under which the model-type damping filter is activated	
Control mode	• Must be position controlled with two degree-of-freedom control enabled.

2) Caution

The model-type damping filter may not work properly or no effect can be obtained under the following conditions.

Conditions hindering the model-type damping filter	
Load condition	<ul style="list-style-type: none"> • Vibrations are excited by factors other than commands (such as external forces). • The resonance frequency and the anti-resonance frequency are out of the range between 5.0 and 300.0 [Hz].

The damping filter works in a conventional manner under the following conditions.

Conditions under which the damping filter works in a conventional manner	
Parameter setting	<ul style="list-style-type: none"> • The resonance frequency and the anti-resonance frequency do not satisfy the following equation: $5.0 \text{ [Hz] or below} \leq \text{Anti-resonance frequency} \leq \text{Resonance frequency} \leq 300.0 \text{ [Hz]}$ • The response frequency and the anti-resonance frequency do not satisfy the following equation: $5.0 \text{ [Hz] or below} \leq \text{Anti-resonance frequency} \leq \text{Response frequency} \leq \text{Anti-resonance frequency} \times 4 \leq 300.0 \text{ [Hz]}$ • With the value in Pr. 2.13 "Damping filter switching selection" set to 4, the 1st and 2nd model-type damping filters are both enabled, and multiplying the 1st and 2nd response frequency/anti-resonance frequency ratios gives a value larger than 8. (In this case, only the 2nd model-type damping filter works as a conventional damping filter.)

When the damping filter works in a conventional manner, the three parameters of anti-resonance frequency, anti-resonance attenuation ratio and response frequency will be used for damping frequency, damping depth and damping filter setting.

To completely disable this function, all of the five parameters of resonance frequency, resonance attenuation ratio, anti-resonance frequency, anti-resonance attenuation ratio and response frequency should be set to 0.

3) Relevant parameters

Set up the model-type damping filter using the following parameters.

Class	No.	Attribute *1)	Title	Range	Unit	Function																																																				
2	13	B	Selection of damping filter switching	0-6	-	<p>Among 4 filters select the filters to be used for damping control.</p> <ul style="list-style-type: none"> When setup value is 0: Up to 2 filters can be used simultaneously. When setup value is 1 or 2: Reserved for manufacturer's use (do not set this) With setup value 3: Select the filter with command direction. <table border="1"> <thead> <tr> <th>Pr 2.13</th> <th>Position command direction</th> <th>1st damping</th> <th>2nd damping</th> <th>3rd damping</th> <th>4th damping</th> </tr> </thead> <tbody> <tr> <td rowspan="2">3</td> <td>Positive direction</td> <td>Enabled</td> <td>Disabled</td> <td>Enabled</td> <td>Disabled</td> </tr> <tr> <td>Negative direction</td> <td>Disabled</td> <td>Enabled</td> <td>Disabled</td> <td>Enabled</td> </tr> </tbody> </table> <p>Contents of setup values 4 to 6 will differ with enabled/disabled switching of two-degree-of-freedom control mode.</p> <ul style="list-style-type: none"> Position control (Two-degree-of-freedom control mode disabled) <table border="1"> <thead> <tr> <th>Pr 2.13</th> <th>1st damping</th> <th>2nd damping</th> <th>3rd damping</th> <th>4th damping</th> </tr> </thead> <tbody> <tr> <td>4</td> <td>Enabled</td> <td>Enabled</td> <td>Enabled</td> <td>Disabled</td> </tr> <tr> <td>5, 6</td> <td colspan="4">Same as with setup value 0</td> </tr> </tbody> </table> <ul style="list-style-type: none"> Position control (Two-degree-of-freedom control mode enabled) <table border="1"> <thead> <tr> <th>Pr. 2.13</th> <th>1st model-type damping</th> <th>2nd model-type damping</th> </tr> </thead> <tbody> <tr> <td>4</td> <td>Enabled</td> <td>Enabled</td> </tr> <tr> <td>5</td> <td colspan="2">For manufacturer's use (do not set this)</td> </tr> </tbody> </table> <table border="1"> <thead> <tr> <th>Pr. 2.13</th> <th>Position command direction</th> <th>1st model-type damping</th> <th>2nd model-type damping</th> </tr> </thead> <tbody> <tr> <td rowspan="2">6</td> <td>Positive direction</td> <td>Enabled</td> <td>Disabled</td> </tr> <tr> <td>Negative direction</td> <td>Disabled</td> <td>Enabled</td> </tr> </tbody> </table>	Pr 2.13	Position command direction	1st damping	2nd damping	3rd damping	4th damping	3	Positive direction	Enabled	Disabled	Enabled	Disabled	Negative direction	Disabled	Enabled	Disabled	Enabled	Pr 2.13	1st damping	2nd damping	3rd damping	4th damping	4	Enabled	Enabled	Enabled	Disabled	5, 6	Same as with setup value 0				Pr. 2.13	1st model-type damping	2nd model-type damping	4	Enabled	Enabled	5	For manufacturer's use (do not set this)		Pr. 2.13	Position command direction	1st model-type damping	2nd model-type damping	6	Positive direction	Enabled	Disabled	Negative direction	Disabled	Enabled
Pr 2.13	Position command direction	1st damping	2nd damping	3rd damping	4th damping																																																					
3	Positive direction	Enabled	Disabled	Enabled	Disabled																																																					
	Negative direction	Disabled	Enabled	Disabled	Enabled																																																					
Pr 2.13	1st damping	2nd damping	3rd damping	4th damping																																																						
4	Enabled	Enabled	Enabled	Disabled																																																						
5, 6	Same as with setup value 0																																																									
Pr. 2.13	1st model-type damping	2nd model-type damping																																																								
4	Enabled	Enabled																																																								
5	For manufacturer's use (do not set this)																																																									
Pr. 2.13	Position command direction	1st model-type damping	2nd model-type damping																																																							
6	Positive direction	Enabled	Disabled																																																							
	Negative direction	Disabled	Enabled																																																							
6	61	B	1st resonance frequency	0-3000	0.1Hz	Defines the resonance frequency of the model-type damping filter's load. The unit is [0.1 Hz].																																																				
6	62	B	1st resonance attenuation ratio	0-1000	-	Defines the resonance attenuation ratio of the model-type damping filter's load. The attenuation ratio can be set as the setup value multiplied by 0.001. The value of 1000 results in an attenuation of 1 (no peak). The smaller the setup value, the smaller the attenuation ratio (higher resonance peak).																																																				
6	63	B	1st anti-resonance frequency	0-3000	0.1Hz	Defines the anti-resonance frequency of the model-type damping filter's load. The unit is [0.1 Hz].																																																				
6	64	B	1st anti-resonance attenuation ratio	0-1000	-	Defines the anti-resonance attenuation ratio of the model-type damping filter's load. The attenuation ratio can be set as the setup value multiplied by 0.001. The value of 1000 results in an attenuation of 1 (no peak). The smaller the setup value, the smaller the attenuation ratio (higher resonance peak).																																																				
6	65	B	1st response frequency	0-3000	0.1Hz	Defines the response frequency of the model-type damping filter's load. The unit is [0.1 Hz].																																																				

(To be continued)

Class	No.	Attribute *1)	Title	Range	Unit	Function
6	66	B	2nd resonance frequency	0-3000	0.1Hz	Defines the 2nd resonance frequency of the model-type damping filter's load. The unit is [0.1 Hz].
6	67	B	2nd resonance attenuation ratio	0-1000	-	Defines the 2nd resonance attenuation ratio of the model-type damping filter's load. The attenuation ratio can be set as the setup value multiplied by 0.001. The value of 1000 results in an attenuation of 1 (no peak). The smaller the setup value, the smaller the attenuation ratio (higher resonance peak).
6	68	B	2nd anti-resonance frequency	0-3000	0.1Hz	Defines the 2nd anti-resonance frequency of the model-type damping filter's load. The unit is [0.1 Hz].
6	69	B	2nd anti-resonance attenuation ratio	0-1000	-	Defines the 2nd anti-resonance attenuation ratio of the model-type damping filter's load. The attenuation ratio can be set as the setup value multiplied by 0.001. The value of 1000 results in an attenuation of 1 (no peak). The smaller the setup value, the smaller the attenuation ratio (higher resonance peak).
6	70	B	2nd response frequency	0-3000	0.1Hz	Defines the 2nd response frequency of the model-type damping filter's load. The unit is [0.1 Hz].

*1) For parameter attribute, refer to Section 9-1.

4) How to use

- [1] As preparation, measure the resonance frequency and anti-resonance frequency using the frequency characteristic measuring function of setup support software PANATERM with torque velocity mode.
Ex.) The figure below shows the measurement result with a belt device. Ignoring small resonances, the resonance frequency at the gain peak and the anti-resonance frequency at the gain valley are as follows:
1st resonance frequency = 130 [Hz], 1st anti-resonance frequency = 44 [Hz]
2nd resonance frequency = 285 [Hz], 2nd anti-resonance frequency=180 [Hz]
- [2] The resonance attenuation ratio and anti-resonance attenuation ratio should have initial values of around 50 (0.050).
- [3] The response frequency should start with the same value as the anti-resonance frequency.
- [4] Specify a value of 4 to 6 in Pr. 2.13 “Selection of damping filter switching” to enable model-type damping control.
- [5] Activate the motor and fine tune the parameters in the following sequence so that vibration components including command position deviation become small.
- (1) Anti-resonance frequency
 - (2) Anti-resonance attenuation ratio
 - (3) Resonance frequency
 - (4) Resonance attenuation ratio
- [6] Once the setting where vibration is minimized was found, increase the setup value of response frequency. The response frequency increases from one to four times the anti-resonance frequency, and the higher the frequency, the smaller the delay due to damping control. However, the damping effect decreases gradually, so a balanced setting should be chosen.

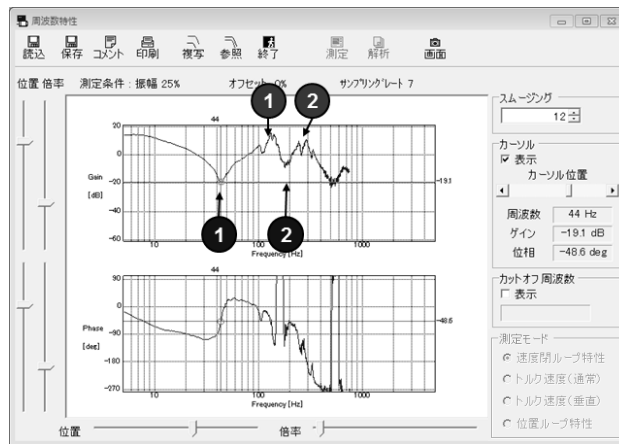

Example of frequency characteristic measurement with setup support software PANATERM

5-2-8 Feed forward function

When position control or full closed control is used, positional deviation can be further reduced when compared with deviation where control is made only by feedback, and response is also improved, by calculating the velocity control command necessary for operation based on the internal positional command, and by adding velocity feed forward to the velocity command calculated by comparison with position feedback. In EtherCAT communication, speed feedforward can be set up at 60B1h (Velocity offset) apart from this.

The response time of the velocity control system is also improved by calculating torque command necessary for operation based on the velocity control command and by adding torque feed forward calculated by comparison with velocity feedback to the torque command. In EtherCAT communication, torque feedforward can be set up by 60B2h (Torque offset) apart from this.

The feed forward given through EtherCAT communication is added to the feed forward value (internally calculated according to the parameter setting).

1) Relevant parameters

For MINAS-A6BL series, the velocity feed forward and torque feed forward can be used.

Class	No.	Attribute *1)	Title	Range	Unit	Function
1	10	B	Velocity feed forward gain	0–4000	0.1%	Multiply the velocity control command calculated according to the internal positional command by the ratio of this parameter and add the result to the velocity command resulting from the positional control process.
1	11	B	Velocity feed forward filter	0–6400	0.01 ms	Set the time constant of 1st delay filter which affects the input of velocity feed forward. *2 It becomes invalid in two-degree-of-freedom control mode.
1	12	B	Torque feed forward gain	0–2000	0.1%	Multiply the torque command calculated according to the velocity control command by the ratio of this parameter and add the result to the torque command resulting from the velocity control process.
1	13	B	Torque feed forward filter	0–6400	0.01 ms	Set up the time constant of 1st delay filter which affects the input of torque feed forward.

*1) For parameter attribute, refer to Section 9-1.

2) Usage example of velocity feed forward

The velocity feed forward will become effective as the velocity feed forward gain is gradually increased with the velocity feed forward filter set at approx. 50 (0.5 ms). The positional deviation during operation at a constant velocity is reduced as shown in the equation below in proportion to the value of velocity feed forward gain.

$$\text{Positional deviation [unit of command]} = \frac{\text{command velocity [unit of command/s]} / \text{positional loop gain [1/s]} \times (100 - \text{velocity feed forward gain [\%]}) / 100$$

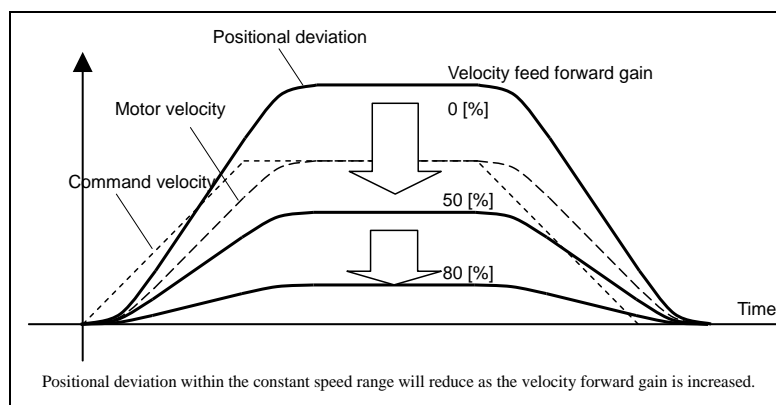

With the gain set at 100%, calculatory positional deviation is 0, but significant overshoot occurs during acceleration/deceleration.

If the updating cycle of the positional command input is longer than the driver control cycle, or the pulse frequency varies, the operating noise may increase while the velocity feed forward is active. If this is the case, use positional command filter (1st delay or FIR smoothing), or increase the velocity forward filter setup value.

3) Usage example of torque feed forward

To use the torque feed forward, correctly set the inertia ratio. Use the value that was determined at the start of the real time auto tuning, or set the inertia ratio that can be calculated from the machine specification to Pr 0.04 Inertia ratio.

The torque feed forward will become effective as the torque feed forward gain is gradually increased with the torque feed forward filter is set at approx. 50 (0.5 ms).

Positional deviation at a constant acceleration/deceleration can be minimized close to 0 by increasing the torque forward gain. This means that positional deviation can be maintained at near 0 over entire operation range while driving in trapezoidal speed pattern under ideal condition where disturbance torque is not active.

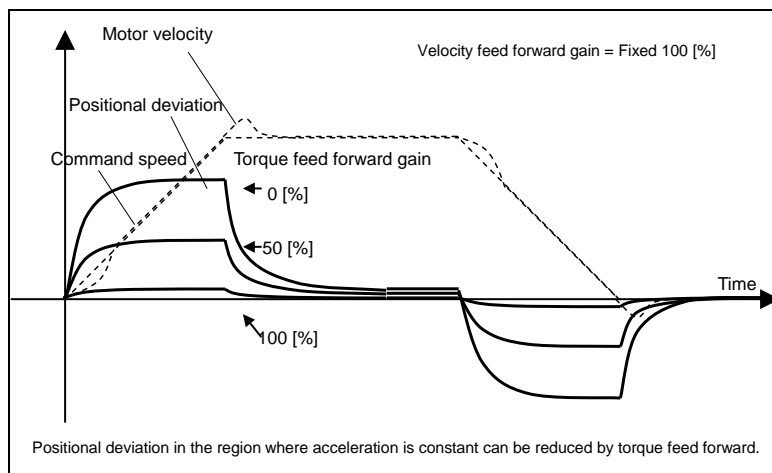

Zero positional deviation is impossible in actual situation because of disturbance torque.

As with the velocity feed forward, large torque feed forward filter time constant decreases the operating noise but increases positional deviation at acceleration change point.

*If the control mode is changed from other than torque control mode to torque control mode while the motor is in operation, torque feed forward may be applied even if torque control mode.

4) Corresponding control mode

In addition, each feedforward which can setup by EtherCAT communication corresponds to the following control mode.

	csp	pp	ip (Not supported)	hm	csv	pv	cst	tq
60B1h (Velocity offset)	valid	valid	valid	valid	valid	valid	invalid	invalid
60B2h (Torque offset)	valid	valid	valid	valid	valid	valid	valid	valid

5-2-9 Load variation suppression function

This function uses the disturbance torque determined by the disturbance observer to reduce effect of disturbance torque and vibration.

This is effective when real-time auto tuning cannot handle load variation sufficiently.

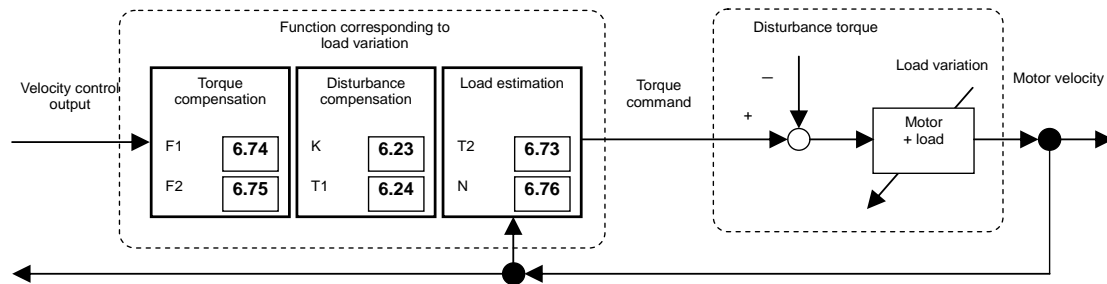

(1) Applicable Range

□ This function can be applicable only when the following conditions are satisfied.

Conditions under which the disturbance observer is activated	
Control model	• Position control, Velocity control
Others	• Should be in servo-on condition • Parameters except for controls such as torque limit setup, are correctly set, assuring that the motor can run smoothly.

(2) Caution

□ Effect may not be expected in the following condition.

Conditions which obstruct disturbance observer action	
Load	•The rigidity is low (the anti-resonance point is at low frequency range of 10 Hz or below) •The load shows a clear non-linear trend with friction and backlash.
Others	•The feedback scale resolution is low. (1 μm/pulse or more)

(3) Relevant parameters

Class	No.	Attribute *1)	Title	Range	Unit	Function
6	10	B	Function expansion setup	-32768–32767	-	Enables or disables the load variation suppression function. bit1 0: Disables the load variation suppression function 1: Enables the load variation suppression function bit2 0: Disables the load variation stabilization setting 1: Enables the load variation stabilization setting bit14 0: Disables the load variation suppression function automatic adjustment 1: Enables the load variation suppression function automatic adjustment * The least significant bit is bit0. * When bit14 to 1, it will be bit1 also 1.
6	23	B	Load change compensation gain	-100–100	%	Defines the compensation gain against load variation.
6	24	B	Load change compensation filter	10–2500	0.01 ms	Defines the filter time constant against load variation.
6	73	B	Load estimation filter	0–2500	0.01 ms	Defines the filter time constant for load estimation.
6	74	B	Torque compensation frequency 1	0–5000	0.1 Hz	Defines the filter frequency 1 against the velocity control output. Torque compensation is enabled when the relation between Pr. 6.74 “Torque compensation frequency 1” and Pr. 6.75 “Torque compensation frequency 2” satisfies the following formula. $1.0 \text{ Hz} \leq \text{Pr. 6.75} \leq \text{Pr. 6.74} \leq (\text{Pr. 6.75} \times 32)$
6	75	B	Torque compensation frequency 2	0–5000	0.1 Hz	Defines the filter frequency 2 against the velocity control output. Torque compensation is enabled when the relation between Pr. 6.74 “Torque compensation frequency 1” and Pr. 6.75 “Torque compensation frequency 2” satisfies the following formula. $1.0 \text{ Hz} \leq \text{Pr. 6.75} \leq \text{Pr. 6.74} \leq (\text{Pr. 6.75} \times 32)$
6	76	B	Load estimation count	0–8	-	Defines the load estimation count.

*1) For parameter attribute, refer to Section 9-1.

4) How to use

There are two methods below for adjusting the load variation suppression function.

■ When there is no load inertia variation (disturbance suppression setting)

< Basic adjustment >

[1] Make normal gain adjustment in advance.

Use real-time auto tuning (Pr. 0.02=1) with the load variation suppression function automatic adjustment disabled (Pr. 6.10 bit14=0), and set stiffness (Pr. 0.03) as high as possible.

[2] Set bit14 to 1 in Pr. 6.10 “Function expansion setup” to enable the load variation suppression function automatic adjustment, and check disturbance suppression effect with the motor rotate.

* This Pr.6.10 bit1 and 2 it will be 1.

* Before enabling or disabling the load variation suppression function, turn off the servo first.

* If this change causes the motor to oscillate or generates an abnormal sound, return to Step [1] and decrease the servo rigidity by one or two levels before repeating the subsequent steps.

< If further adjustment >

[3] Set bit14 to 0 in Pr. 6.10 to disable the automatic adjustment of load variation suppression function.

[4] Specify a small value as possible in Pr. 6.24 “Load change compensation filter”.

Decreasing the filter setup value within the range that does not produce any significant abnormal sound or torque command variation will improve disturbance suppression performance and reduce motor velocity variation and encoder position deviation.

* When an abnormal sound at high frequency (1 kHz or above) is generated, increase the value in Pr. 6.76 “Load estimation count.”

* When vibration at low frequency (10 Hz or below) is produced after operation stops, increase the value in Pr. 6.23 “Load change compensation gain”.

* No change is required for Pr. 6.73 “Load estimation filter” in normal cases, but you can set the optimum point by fine-tuning within the range between around 0.00 and 0.20 ms.

- When there is load inertia variation (load variation stabilization setting) (assumed an articulated robot, etc.)
- [1] Confirm the maximum and minimum values in Pr. 0.04 "Inertia ratio."
Possible methods for doing this are as follows.
 - 1) Make theoretical calculation based on the system design information
 - 2) Operate the system within the range not significantly varying the inertia ratio while changing the system's posture/condition, and read out the acceleration/deceleration torque and motor acceleration. Then, make calculation from the equation: Total inertia = torque / acceleration
 - 3) While operating within the range not significantly varying the inertia ratio, check the inertia estimation value with Pr. 0.02 = 5 (load characteristic measuring mode) of real-time auto tuning.
 - 4) If no information can be obtained, use 0% as minimum value and the motor's permissible load inertia as maximum value.
 - * For an articulated robot, make measurement while moving it to the posture where the load inertia becomes maximum/minimum for each joint.
 - * For pick & place equipment, make measurement with maximum payload and no load.
 - [2] Make gain adjustment under the following conditions.
With the load variation suppression function disabled (Pr. 6.10 bit1=0) and in the posture/condition where Pr. 0.04 "Inertia ratio" becomes minimum, make gain adjustment by specifying the maximum value in Pr. 0.04 "Inertia ratio."
 - * Make adjustment so that Pr. 1.01 "1st velocity loop gain"(Kvp) becomes as high as possible.
 - * Please note that in applications where a large and steep load inertia variation is generated, the real-time auto tuning function and adaptive filter may not be able to correctly estimate load, which may result in oscillation and vibration.
 - [3] Turn off the servo and then specify initial values in the following parameters.
Pr. 0.02 "Real-time auto tuning mode setting" = 0 (disabled)
Change Pr. 0.04 "Inertia ratio" to the minimum value in [1].
Pr. 1.00 "1st position loop gain" = Pr. 1.01 "1st velocity loop gain"
Pr. 1.02 "1st velocity integration time constant" = 1000.0 ms (disabled)
Pr. 6.23 "Load variation compensation gain" = 100%
Pr. 6.24 "Load variation compensation filter" = Time constant converted value of velocity loop gain (Kvp)
(Ex: where the rigidity is 16, Kvp=50.0 Hz, then Pr. 6.24 =1/(Kvp*2 π) = 3.18 ms)
Pr. 6.73 "Load estimation filter" = 0.10 ms
Pr. 6.76 "Load estimation count" = 4
 - [4] Change the following parameter setting according to the variation ratio α of the total inertia.
Pr. 6.74 "Torque compensation frequency 1" = frequency converted value Hz in Pr. 6.24
(Ex.: If Pr. 6.24 = 3.18 ms = 0.00318 s, then the frequency converted value = 1/ (Pr. 6.24[s]*2 π) = 50.0 Hz)
Pr. 6.75 "Torque compensation frequency 2" = frequency converted value Hz/ α in Pr. 6.24
 - * The variation ratio α of the total inertia is the ratio of the maximum and minimum (>1) values of the aggregated inertia of the motor and load. The value in Pr. 0.04 "Inertia ratio," which can be calculated by real-time auto tuning, does not include the inertia portion of the motor, and thus the following calculation should be made to compute the total inertia to obtain the variation ratio α .
Variation ratio $\alpha = ((\text{maximum value in Pr. 0.04}) + 100\%) / ((\text{minimum value in Pr. 0.04}) + 100\%)$
 - [5] Set bit1 to 1 in Pr. 6.10 "Function expansion setting" to enable the load variation suppression function.
 - * Before enabling or disabling the load variation suppression function, turn off the servo first.
 - * If this change causes the motor to oscillate or generates an abnormal sound, turn off the servo and then increase the value of Pr. 6.24 in Step [3] to a value about twice as large. Then reset Pr. 6.74 and Pr. 6.75 in Step [4] to enable it. If the oscillation or abnormal sound still persists, return to Step [1] and decrease the velocity loop gain by about 50% to 75% before repeating the subsequent steps.
 - [6] Specify a small value as possible in Pr. 6.24 "Load variation compensation filter."
In addition to changing Pr. 6.24, carry out Step [4] to increase Pr. 6.74 and Pr. 6.75.
Specifying a smaller value within the range that does not produce any significant abnormal sound or torque command variation will improve the stability against load variation. Try various operations including the posture and condition where the load inertia becomes maximum or minimum to check the motor operation.
 - * When an abnormal sound at high frequency (1 kHz or above) is generated, increase the value in Pr. 6.76 "Load estimation count."

5-2-10 3rd gain switching function

In addition to the normal gain switching function described on 5-2-4, 3rd gain switching function can be set to increase the gain just before stopping. The higher gain shortens positioning adjusting time.

(1) Applicable Range

This function can be applicable only when the following conditions are satisfied.

Conditions under which the 3rd gain switching function is activated	
Control mode	• Position control mode
Others	• Should be in servo-on condition • Parameters except for controls such as torque limit setup, are correctly set, assuring that the motor can run smoothly.

(2) Relevant parameters

Class	No.	Attribute *1)	Title	Range	Unit	Function
6	05	B	Position 3rd gain valid time	0–10000	0.1 ms	Set up the time at which 3rd gain becomes valid.
6	06	B	Position 3rd gain scale factor	50–1000	%	Set up the 3rd gain by a multiplying factor of the 1st gain: $3rd\ gain = 1st\ gain \times Pr\ 6.06/100$

*1) For parameter attribute, refer to Section 9-1.

(3) How to use

While in the condition under which the normal gain switching functions, set the 3rd gain application time to Pr 6.05 Position 3rd gain enable time, and set the 3rd gain (scale factor with reference to 1st gain) to Pr 6.06 Position 3rd gain magnification ratio.

- If 3rd gain is not used, set Pr 6.05 to 0 and Pr 6.06 to 100.
- The 3rd gain is enabled only for position control.
- During the 3rd gain period, only position loop gain/velocity loop gain becomes 3rd gain, during other periods, 1st gain setting is used.
- When the 2nd gain switching condition is established during 3rd gain period, 2nd gain is used.
- During transition from 2nd gain to 3rd gain, Pr 1.19 Position gain switching time is applied.
- Even if the gain is changed from 2nd to the 1st due to parameter change, the 3rd gain period is inserted between them.

Example:

Pr 1.15 Mode of position control switching = 7 switching condition: with positional command:

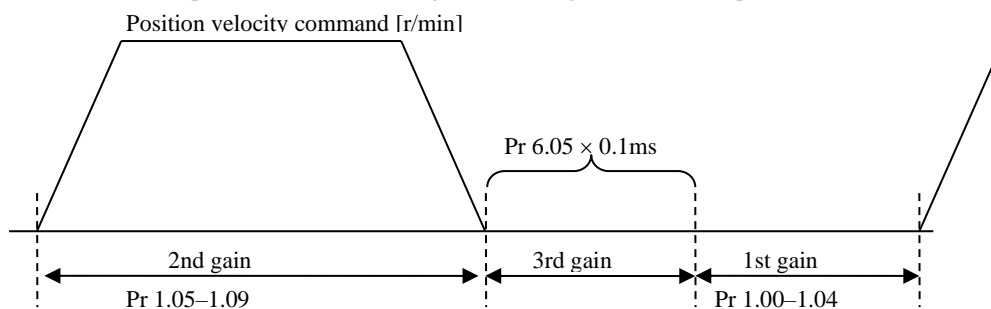

[3rd gain period]

Position loop gain = $Pr1.00 \times Pr6.06/100$

Velocity loop gain = $Pr1.01 \times Pr6.06/100$

Velocity loop integration time constant, velocity detection filter and torque filter time constant directly use the 1st gain value.

5-2-11 Friction torque compensation

To reduce effect of friction represented by mechanical system, 3 types of friction torque compensation can be applied:

- offset load compensation that cancels constant offset torque
- The dynamic friction compensation that varies direction as the operating direction varies
- viscous friction torque correction amount that is varied by the command speed

(1) Applicable Range

□ This function can be applicable only when the following conditions are satisfied.

Conditions under which the Friction torque compensation is activated	
Control mode	• Specific to individual functions. Refer to “Parameters” shown below.
Others	• Should be in servo-on condition • Parameters except for controls such as torque limit setup, are correctly set, assuring that the motor can run smoothly.

(2) Relevant parameters

Combine the following 3 parameters to setup appropriate friction torque compensation.

Class	No.	Attribute *1)	Title	Range	Unit	Function
6	07	B	Torque command additional value	-100-100	%	Set up the offset load compensation value usually added to the torque command in a control mode except for the torque control mode.
6	08	B	Positive direction torque compensation value	-100-100	%	Dynamic friction compensation value to be added to the torque command at the time of position control and when forward direction position command is entered.
6	09	B	Negative direction torque compensation value	-100-100	%	Dynamic friction compensation value to be added to the torque command at the time of position control and when reverse direction position command is entered.
6	50	B	Viscous friction compensating gain	0-10000	0.1% (10000r/min)	When Two-degree-of-freedom control mode is effective, the result multiplying the command speed by this setting is added to the torque command as the viscous friction torque correction amount. By setting the estimated viscous friction coefficient of real-time auto tuning, there are cases in which the feedback scale position deviation in the vicinity of steady state may be improved.

*1) For parameter attribute, refer to Section 9-1.

(3) How to use

The friction torque compensation will be added in response to the entered positional command direction as shown below.

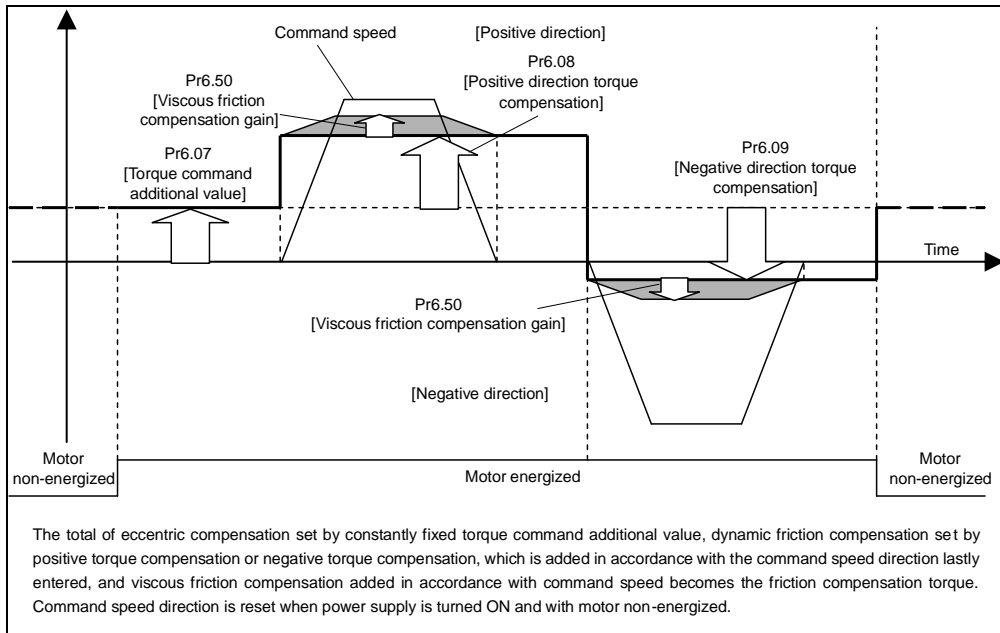

Pr 6.07 [Torque command additional value] reduces variations in positioning operation (performance is affected by direction of movement). These variations occur when constant offset torque resulting from weight on vertical axis is applied to the motor.

Certain loads such as belt driven shaft requires high dynamic friction torque, which lengthens positioning setting time or varies positioning accuracy. These problems can be minimized by setting the friction torque of every rotating direction into individual parameters. Pr 6.08 [Positive direction torque compensation value] and Pr 6.09 [Negative direction torque compensation value] can be used for this purpose.

Pr6.50 “viscous friction compensation gain” reduces response delay at the time of acceleration by setting a torque command value against viscous load. Because of its properties, the compensation is proportional to the speed command value.

The offset load compensation and dynamic friction compensation can be used individually or in combination. However, some control modes impose limit on application.

- For torque control: Offset load compensation and dynamic friction compensation are set at 0 regardless of parameter setting.
- For velocity control with servo-off: Offset load compensation per Pr 6.07 is enabled. Dynamic friction compensation is set at 0 regardless of parameter setting.
- For position control with servo-on: Previous offset load compensation and dynamic friction compensation values are maintained until the first positional command is applied where the offset load compensation value is updated according to Pr 6.07. The dynamic friction compensation value is updated to parameters Pr .6.08 and Pr 6.09 depending on command direction.

5-2-12 Two-stage torque filter

In addition to usual 1st and 2nd torque filters (Pr1.04 and Pr1.09), another torque filter can be set. High-frequency vibration component can be suppressed by the use of the 2-stage torque filter.

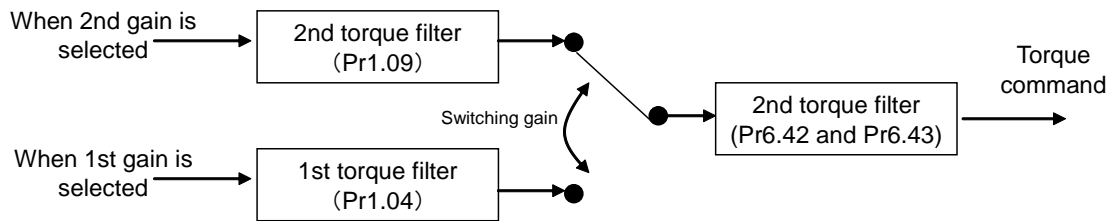

(1) Application Range

This function can't be applied unless the following conditions are satisfied.

Conditions for operating 2-stage torque filter	
Control mode	• Can be used in all control modes.
Others	• In servo-ON state • Elements, such as deviation counter clear command input inhibition and torque limit, other than control parameter are set properly, and motor is running without any problem.

(2) Cautions

- If the setting value is increased excessively, the control may become unstable to produce vibration. Specify proper setting value while checking the status of the device.
- If Pr6.43 “2-stage torque filter attenuation term” is changed during operation, vibration may be generated. Change the value while the motor is stopped.

(3) Relevant parameters

Class	No.	Attribute *1)	Title	Range	Unit	Function
6	42	B	2-stage torque filter time constant	0–2500	0.01ms	Sets 2-stage torque filter time constant. The time constant is invalid if 0 is specified. [When used for the secondary filter as Pr6.43 ≥ 50] The time constants that can be used are 4–159 (0.04–1.59 ms). (Equivalent to 100–4000 Hz in frequency) Setting values 1–3 works as 4 (4000 Hz), and 159–2500 works as 159 (100 Hz).
6	43	B	2-stage torque filter attenuation term	0–1000	—	Sets attenuation term of 2-stage torque filter. The filter degree of the 2-stage torque filter is changed according to the setting value. 0–49: Operates as the 1st filter. 50–1000: Operates as a 2nd filter and becomes a 2nd filter with $\zeta = 1.0$ if setting value is 1000. As the setting value is decreased, the filter becomes vibrational. Use with a setting value 1000 basically.

*1) For parameter attribute, refer to Section 9-1.

(4) How to use

Set a 2-stage torque filter if high-frequency vibration can't be removed only using usual 1st and 2nd torque filters. Setting Pr6.43 “2-stage torque filter attenuation term” to 1000 ($\zeta=1.0$), adjust Pr6.42 “2-stage torque filter time constant”.

5-2-13 Quadrant projection suppression function

Control configuration can be switched to suppress quadrant projection occurring during arc interpolation of 2 or more axes. To be used in conjunction with load fluctuation suppression function.

(1) Applicable Range

- This function is unable to be applied unless the following conditions are satisfied:

Conditions in which quadrant projection suppression function is triggered	
Control mode	• Position control mode
Others	• To be in Servo-On state. • Elements other than control parameters, such as prohibition of deviation counter clear command input and torque limit, etc. are set appropriately, in a state where there are no obstructions in normal motor revolutions.

(2) Caution

- There are cases where effects cannot be observed under the following conditions:

Conditions where the effects of quadrant projection suppression function is disrupted	
Load	• When rigidity is low (anti-resonance point exists in the low frequency range of 10 Hz or lower) • When non-linearity of load is strong from existence of backlash, etc. • When action patterns are changed.

(3) Relevant parameters

Class	No.	Attribute *1)	Title	Range	Unit	Function
5	45	B	Quadrant glitch positive-direction compensation value	-1000–1000	0.1%	Sets amount of compensation to be added to torque command when the position command is in positive direction and quadrant projection compensation function is enabled.
5	46	B	Quadrant glitch negative-direction compensation value	-1000–1000	0.1%	Sets amount of compensation to be added to torque command when the position command is in negative direction and quadrant projection compensation function is enabled.
5	47	B	Quadrant glitch compensation delay time	0–1000	ms	Sets the length of delay time for switching of amount of compensation after position command has been reversed, when quadrant projection compensation function is enabled.
5	48	B	Quadrant glitch compensation filter setting L	0–6400	0.01 ms	Sets time constant for low-pass filter on the amount of compensation on torque command when quadrant projection compensation function is enabled.
5	49	B	Quadrant glitch compensation filter setting H	0–10000	0.1 ms	Sets time constant for high-pass filter on the amount of compensation on torque command when quadrant projection compensation function is enabled.
6	47	R	Function expansion setup 2	-32768–32767	–	bit14: Enables/disables quadrant projection compensation function. 0: disabled, 1: enabled
6	97	B	Function expansion setup 3	-2147483648–2147483647	–	bit0: Enables/disables quadrant projection compensation function extended. 0: disabled, 1: enabled * To set the compensation amount of quadrant projection by inversion direction when the direction of the velocity has changed, set Pr6.97 bit0 to 1.

*1) For parameter attribute, refer to Section 9-1.

(4) How to use

Adjust the load change inhibit function using the disturbance suppression setup by reference to Section 5-2-10, and measure quadrant projection.

Level is unsatisfactory, conduct further fine adjustment using quadrant projection suppression function.

[1] Reclose control power supply after enabling quadrant projection suppression function (Pr 6.47 bit14 = 1)

[2] Set initial values to: Pr 5.47 = 0, Pr 5.48 = Pr 1.04, Pr 5.49 = 0.

[3] Measure the magnitude of quadrant projection and conduct fine adjustments to Pr 5.45 and Pr 5.46 of each axis.

* When quadrant projection is delayed from the timing of the movement direction is reversed, try changing Pr 5.47 and Pr 5.48.

* To set the compensation amount of quadrant projection by inversion direction when the direction of the velocity has changed, set Pr6.97 bit0 to 1 and try change Pr5.49.

5-2-14 Two-degree-of-freedom control mode (with position control)

The two-degree-of-freedom control mode is an expanded function of the position control switching mode. Responsiveness is improved by making it possible to set the positional command response and servo stiffness independently.

Either of the standard type or synchronization type of the two-degree-of-freedom control can be used.

(1) Applicable Range

This function cannot be applied unless the following conditions are satisfied.

Operating conditions for the two-degree-of-freedom control mode	
Control mode	• Position control mode
Other	• The servo is ON. • Elements other than control parameters such as torque limit are set properly, and there is no obstacle to normal motor operation.

(2) Relevant parameters

First, set Pr6.47 “Function expansion setup 2” to bit0=1 and write the setting to EEPROM, and then reset the control power to enable two-degree-of-freedom control.

After this, make adjustments of the real-time auto-tuning function (refer to Section 5-1-3 or 5-1-4).

Only when further improvement is required, manually fine-tune the following parameters while confirming the response.

Class	No.	Attribute *1)	Title	Range	Unit	Function
6	47	R	Function expansion setup 2	-32768–32767	–	Set respective functions in unit of bit. bit0 two-degree-of-freedom control mode 0: Invalid 1: Valid bit3 For manufacturer’s use Fix to 0. * The least significant bit is bit0.
2	22	B	Command smoothing filter	0–10000	0.1ms	Time constant for the command filter is set in two-degree-of-freedom control. • The maximum value is limited to 2000 (=200.0 ms). *The parameter value itself is not limited, but the value applied in the driver is limited. • Command response can be quickened by decreasing this parameter and slowed by increasing it. • The attenuation term is set by Pr6.49 “Adjust/Torque command attenuation term”.
6	48	B	Adjust filter	0–2000	0.1ms	Set the time constant for the adjust filter. • When the torque filter setting has been changed, set a value close to the real-time auto-tuning setting. • As a result of fine-tuning while checking the encoder position deviation near the setting, overshoot and oscillatory waveforms may be improved. • The attenuation term is set by Pr6.49 “Adjust/Torque command attenuation term”.

(To be continued)

Class	No.	Attribute *1)	Title	Range	Unit	Function
6	49	B	Command / tuning filter damping	0-99	-	<p>Set the attenuation term for the command filter and adjust filter.</p> <ul style="list-style-type: none"> A decimal number indication is used. The first digit sets the command filter and the second digit sets the adjust filter. <p><Each target digit of the set value> 0 to 4: No attenuation term (operated as primary filter) 5 to 9: Secondary filter (Attenuation terms, ζ will be 1.0, 0.86, 0.71, 0.50, and 0.35 in order.)</p> <p><Setting an example of this parameter> To set the command filter to $\zeta=1.0$ and adjust filter 1 to $\zeta=0.71$, the setting value should be 75 (first digit=5 ($\zeta=1.0$), second digit=7 ($\zeta=0.71$)). For the time constant of the command filter, Pr2.22 "Command smoothing filter" will be applied.</p>
6	50	B	Viscous friction compensation gain	0-10000	0.1%/ (10000r/min)	<p>Add the result of multiplying the command velocity by this setting value to the torque command as the correction amount of the viscous friction torque.</p> <ul style="list-style-type: none"> The encoder position deviation near the setting may be improved by setting the viscous friction factor estimation for real-time auto-tuning.

*1) For the parameter attributes, refer to Section 9-1.

- *2) The configuration of "the adjustment filter and command response filter settings or the adjustment filter attenuation term setting" is switched when the output of positioning completion is ongoing, and at the same time, when the command pulse (before the position command filter), which changes from the 0 state to other state than 0 at intervals of command pulse detection (0.125 ms), rises. The configuration does not switch if the control mode is changed to position control after the values for "the adjustment filter and command response filter settings or the adjustment filter attenuation term setting" are changed during speed control or torque control. When especially the constant applied to the adjustment filter is changed to a smaller value, and at the same time, a wider positioning completion range is set up, the motor may temporarily run faster than instructed because it rushes to the position at which it should be, due to the accumulated great pulse (surface area obtained by integrating, based on time, the pre-filtering position command value, from which the post-filtering position command value is subtracted), which is abruptly delivered immediately after switching is performed if left in the filter at the moment of the above switching. Be careful of this.
- *3) There is a delay before the change of the values for "the adjustment filter and command response filter settings or the adjustment filter attenuation term setting" is applied to the internal calculations after changed, and if a switching timing described in *2) comes during the delay, the change may be put on hold.

(3) Two-degree-of-freedom control mode (with position control)

The mode of 2 degrees of freedom control is configured as shown in the block diagram below.

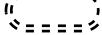
 Monitor data for PANATERM
 Monitor data for CiA402 object

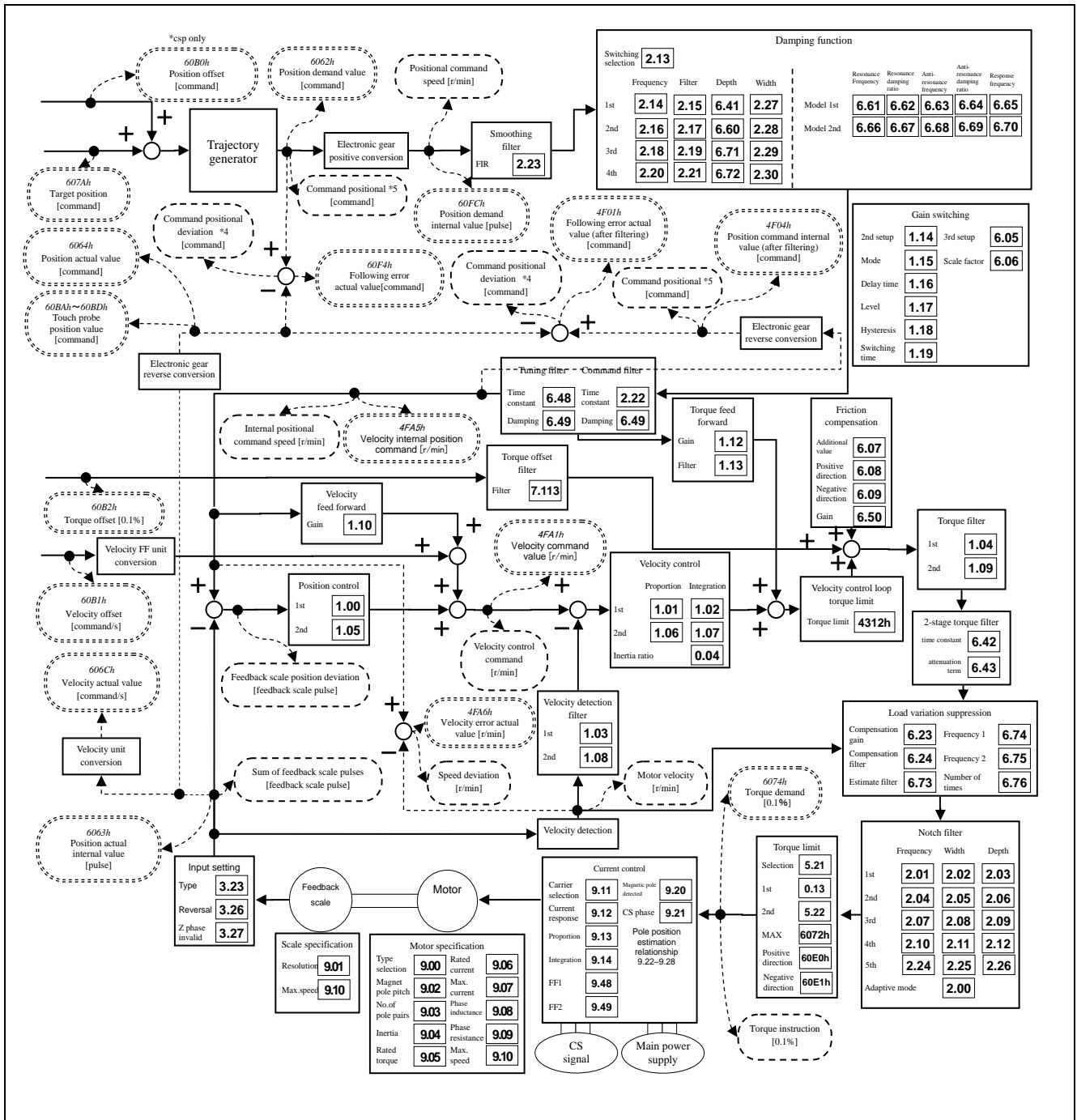

Two-degree-of-freedom control mode (with position control) block diagram

- *1) A slanting number shows (ex: 607Ah) the object number of EtherCAT.
- *2) A bold letter number shows (ex: **1.00**) a parameter number.
- *3) Polarity was omitted.
- *4) The method to calculate the positional deviation on PANATERM (standard) varies depending on the setting of the command positional deviation output change (bit 14) of Pr 7.23 (Communication function extended setup 2).
- *5) The position command on PANATERM can be switched depending on the setting of bit3 (Command pulse accumulation value) of Pr7.99(Communication function extended setup 6).
- *6) The amplifier will be switched internally to position control during execution of test run, frequency characteristics analysis (position loop characteristics) from PANATERM.
- *7) The first edition of the software version (Ver1.04) does not support 60E0h/60E1h (Positive/Negative torque limit value).

5-2-15 Two-degree-of-freedom control mode (with velocity control)

The two-degree-of-freedom control mode is an extended function of velocity control mode to improve the responsiveness by making it possible to independently set the command response and servo rigidity. Only the standard type of two-degree-of-freedom control is available.

(1) Applicable Range

This function is unable to be applied unless the following conditions are satisfied.

Conditions in which two-degree-of-freedom control mode is activated.	
Control mode	• Velocity control
Miscellaneous	• To be in the servo ON state. • Elements other than control parameters, such as torque limit, etc. are properly set and the motor is free of obstacle to normal motor rotation.

(2) Relevant parameters

First of all, set Pr6.47 “Function expansion setup 2”:bit0 to 1 and write in EEPROM; then, reset the control power supply to enable the two-degree-of-freedom control mode.



Thereafter, adjust the related parameters by real-time auto-tuning (see 5-1-3). Only when further improvement is required, manually finely adjust the following parameters while confirming responses.

Class	No.	Attribute *1)	Parameter name	Setting range	unit	Functions
6	47	R	Function expansion setup 2	-32768–32767	-	Various functions are set in bit units. bit0 Two-degree-of-freedom mode 0: Invalid 1: Valid bit3 For manufacturer’s use Fix to 0. *The least significant bit is set to bit0.
2	22	B	Command smoothing filter	0–10000	0.1 ms	At the time of the two-degree-of-freedom control, the time constant of command response filter is used. • The maximum value is restricted to 640 (=64.0 ms). *The parameter value itself is not restricted but the applied value inside the driver is restricted. • Making this parameter smaller can quicken the command response, whereas making it larger can slow the command response.
6	48	B	Adjust filter	0–2000	0.1 ms	To set the time constant of adjustment filter. • When the torque filter setting is changed, set the adjustment filter to a near value while referring to setting of real-time auto-tuning. • At the time of speed control mode, The maximum value is restricted to 640 (=64.0 ms). *The parameter value itself is not restricted but the applied value inside the driver is restricted.

*1) For the parameter attributes, refer to Section 9-1.

(3) Block diagram of the two-degrees-of-freedom control mode(with velocity control)

Two-degree-of-freedom control mode (with velocity control) shall be as per the block diagram indicated below.

 Monitor data of PANATERM
 Monitor data of CiA402 object

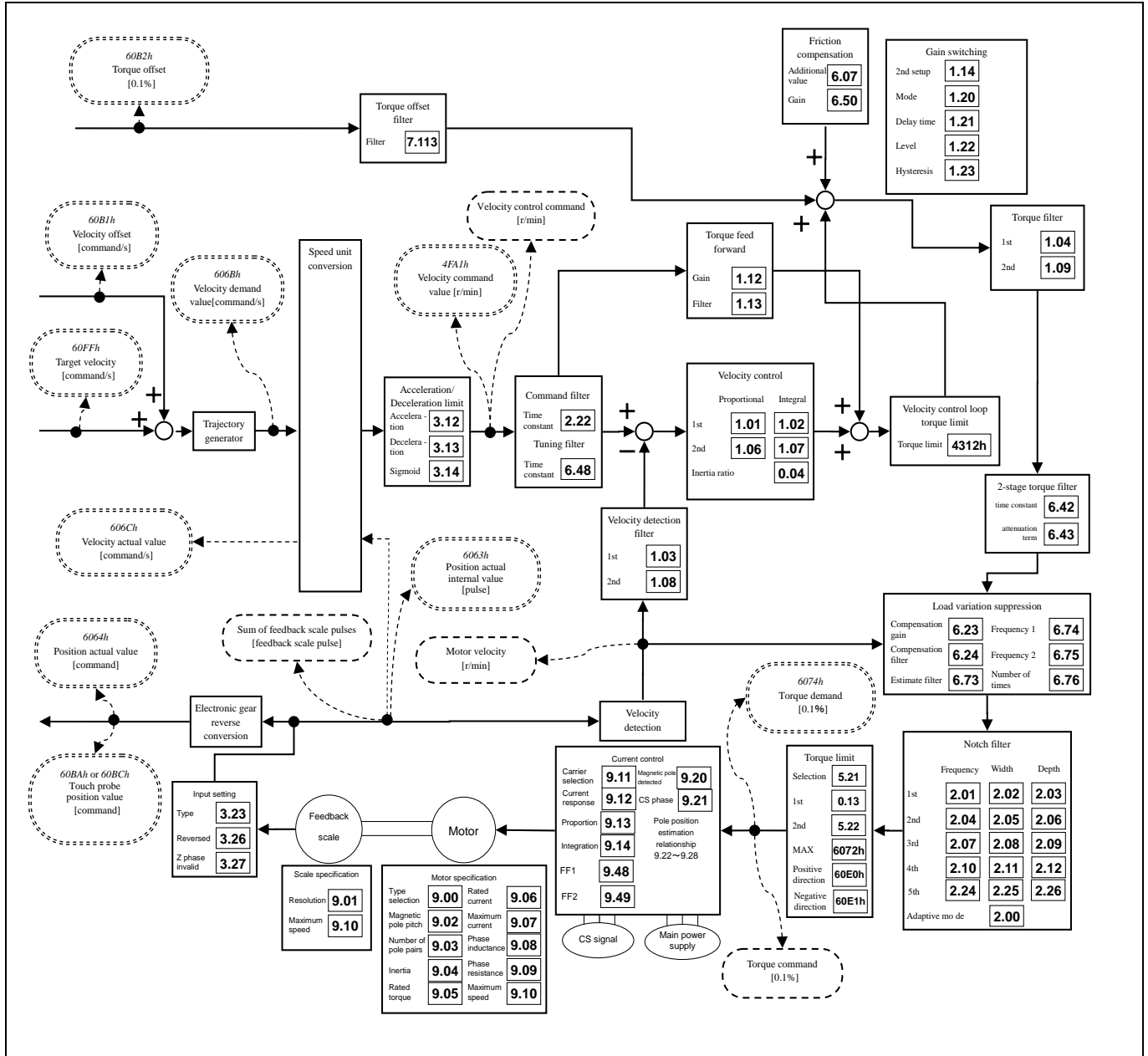

Two-degree-of-freedom control mode (with velocity control) block diagram

- *1) A slanting number shows (ex: 607Ah) the object number of EtherCAT.
- *2) A bold letter number shows (ex: **1.00**) a parameter number.
- *3) Polarity was omitted.
- *4) When performing Frequency characteristic measurement (speed close loop characteristic, Torque speed (Vertical)) from the PANATERM, the driver switches to velocity control mode internally.
- *5) The first edition of the software version (Ver1.04) does not support 60E0h/60E1h (Positive/Negative torque limit value).

5-2-16 Two-degree-of-freedom control mode (with torque control)

The two-degree-of-freedom control mode has an equivalent configuration as the torque control with the two-degree-of-freedom control invalid.

For details, please refer to Section 5-2-3 "Block diagram of torque control mode", EtherCAT communication specification (SX-DSV03307), Section 6-8 "Torque control function (tq,cst)."

6. Application

6-1 Torque limit switching function

It is a function which changes a torque limit value by the direction of operation.

(1) Applicable Range

- This function can be applicable only when the following conditions are satisfied.

Conditions under which the Torque limit switching function is activated	
Control mode	• Position control mode, Velocity control mode and Torque control mode*1)
Others	• Should be in servo-on condition • Parameters except for controls are correctly set, assuring that the motor can run smoothly.

*1) During torque controlling, the switching function is disabled and only Pr. 0.13 1st torque limit is enabled.

(2) Relevant parameters

Class	No.	At-trib-ute *1)	Title	Range	Unit	Function																		
0	13	B	1st torque limit	0-500	%	You can set up the 1st limit value of the motor output torque.																		
5	21	B	Selection of torque limit	0-5	—	You can set up the torque limiting method. <table border="1" style="margin-left: 20px;"> <thead> <tr> <th>Setup value</th> <th>Negative direction</th> <th>Positive direction</th> </tr> </thead> <tbody> <tr> <td>1</td> <td colspan="2">Pr0.13</td> </tr> <tr> <td>2</td> <td>Pr5.22</td> <td>Pr0.13</td> </tr> <tr> <td>3</td> <td colspan="2">Pr0.13</td> </tr> <tr> <td>4</td> <td>Pr5.22</td> <td>Pr0.13</td> </tr> <tr> <td>5</td> <td>60E1h</td> <td>60E0h</td> </tr> </tbody> </table> <p>*If 0 is set for this parameter, 1 is internally set. • Only the setting Pr5.21=5 becomes enabled during torque control. When Pr5.21=1 to 4, Pr0.13 is applied to the torque limit. (Note) The setting range is 0 to 4 in the first edition of the software version (Ver1.04).</p>	Setup value	Negative direction	Positive direction	1	Pr0.13		2	Pr5.22	Pr0.13	3	Pr0.13		4	Pr5.22	Pr0.13	5	60E1h	60E0h
Setup value	Negative direction	Positive direction																						
1	Pr0.13																							
2	Pr5.22	Pr0.13																						
3	Pr0.13																							
4	Pr5.22	Pr0.13																						
5	60E1h	60E0h																						
5	22	B	2nd torque limit	0-500	%	You can set up the 2nd limit value of the motor output torque.																		

*1) For parameter attribute, refer to Section 9-1.

(3) Related object

Index	Sub-Index	Name / Description	Units	Range	Data Type	Access	PDO	Op-mode	EEPROM
6072h	00h	Max torque	0.1%	0 – 65535	U16	rw	Yes	ALL	Yes
		• Set the maximum torque. If the value exceeds the maximum torque of the motor is limited by the maximum torque of the motor. Note: The maximum torque of the motor varies depending on the motor applied.							

Torque command is limited at smaller one of 6072h and those effective for Pr0.13 and Pr5.22.

6-2 Motor working range setup function

If the motor with respect to the position command input range exceeds the motor operating range that is set by Pr5.14“Motor working range setup”, it can be alarm stop at the Err34.0 “motor movable range set protection”.

The allowable motor operating range is calculated internally by the amplifier under the following formula:

- Positive direction allowable motor operating range = Positive direction position command entry input range + Pr5.14
- Negative direction allowable motor operating range = Negative direction position command entry input range - Pr5.14

In case the actual motor position for judgment exceeds this range, Err34.0 “motor movable range set protection” will be detected.

(1) Applicable Range

□ This function can be applicable only when the following conditions are satisfied.

Conditions under which the software limit works	
Control mode	• Position control mode
Others	• Should be in servo-on condition • Parameters except for controls such as torque limit setup, are correctly set, assuring that the motor can run smoothly.

(2) Cautions

- This function is not a protection against the abnormal position command.
- When this software limit protection is activated, the motor decelerates and stops according to 605Eh(Fault reaction option code).
The work (load) may collide to the machine end and be damaged depending on the load during this deceleration, hence set up the range of Pr 5.14 including the deceleration movement.
- When changing the control mode (for the purpose of only to control velocity or torque), do not use this function. Instead, use software limit function or drive inhibit input.
- When any of the following values ([feedback scale pulse] unit) managed internally in the amplifier, exceeds -2^{31} to $2^{31}-1$, Err34.0 “motor movable range set protection” detection process will be invalidated’ .*1
 - Position command input range
 - Actual motor position for judgment
 - Motor movable range
- In case any of the following conditions are satisfied, the position command input range and the actual motor position for judgment managed inside the amplifier will be cleared and Err34.0 “Motor movable range setting error protection” detection process will be invalidated.
 - When the control power is turned on
 - Servo-OFF state
 - Velocity control state or torque control state
 - During frequency response measurement using setup support software (PANATERM).
 - During the time position deviation is cleared (When an EMS state transitions from Init to PreOP, decelerated stop from alarm, etc.).
 - When position information is initialized
When absolute clear by Setup support software (PANATERM) etc.
 - A state in which pole position estimation isn't completed under Pr9.20=2(Pole position estimation method).
 - During automatic linear motor setting by the automatic setting tool (MotorAutoSetup).
 - Pr5.14 = 0

(To be continued)

— In Full-closed control mode, when Pr5.14 satisfies the following formula (when the value of Pr5.14 converted into external pulse units exceeds $2^{31}-1$). *1

Motor type is linear type (Pr9.00 = 1)	$Pr5.14 > (2^{31} - 1) * Pr9.01 / (Pr9.02 * 1000)$ Or $Pr5.14 > (2^{31} - 1) * 10 / Pr9.30$
Motor type is rotary type (Pr9.00 = 2)	$Pr5.14 > (2^{31} - 1) * Pr9.03 * 10 / Pr9.01$
When the motor type is linear (VCM) (Pr9.00=3)	$Pr5.14 > (2^{31} - 1) * Pr9.01 / 1000000$

— When clearing position deviation during deceleration to stop due to over-travel inhibit input

— When returning to home

*1) However, when Err34.0 detection processing is invalid, Err34.0 can be generated by setting the following setting to valid.

Pr6.97 “Function expansion setup 3”

bit2 Expansion of Allowable motor operating range abnormal protection 0: Invalid, 1: Valid

(3) Relevant parameters

Class	No.	Attribute *1)	Title	Range	Unit	Function
5	14	A	Motor working range setup	0-1000	0.1 revolution	You can set up the movable range of the motor against the position command input range. When the motor movement exceeds the setup value, software limit protection will be triggered. When set value of this parameter is 0, Err34.0 become disable. Also in conditions written in above (2) Caution, Err34.0 become disable.
6	97	B	Function expansion setup 3	-2147483648 - 2147483647	-	Sets various function in bit units: bit 2: Expansion of Allowable motor operating range abnormal protection 0: Invalid, 1: valid

*1) For parameter attribute, refer to Section 9-1.

(4) Operation example

(1) When no position command is entered (Servo-ON status)

The motor movable range will be the travel range which is set at both sides of the motor with Pr5.14 since no position command is entered. When the load enters to the Err34.0 occurrence range (oblique line range), software limit protection will be activated.

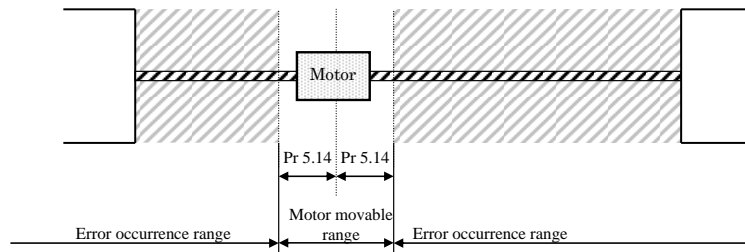

(2) When the load moves to the right (at Servo-ON)

When the position command to the right direction is entered, the motor movable range will be expanded by entered position command, and the movable range will be the position command input range + Pr5.14 setups in both sides.

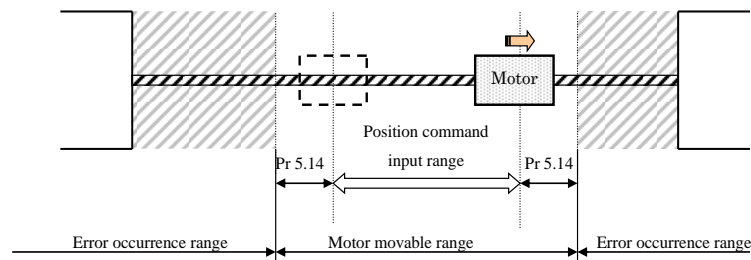

(3) When the load moves to the left (at Servo-ON)

When the position command to the left direction, the position command input range will be expanded further.

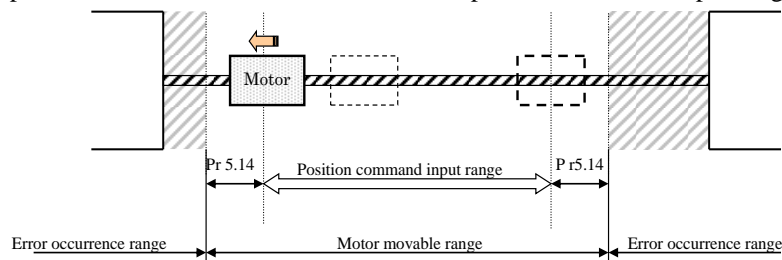

6-3 Deceleration stop sequence

Sets how to decelerate and stop the motor if main power is shut down or an alarm occurs while PDS is Operation enabled state (servo-on state).

Combine the deceleration function (option code) defined by CoE(CiA402) and the deceleration function on the servo (MINAS-A6) side (dynamic brake stop, free-run stop, emergency stop).

Change the deceleration setting from the shipment value according to the equipment environment.

For each parameter and the shipment values of the EtherCAT objects, refer to the specification.

Please refer to section 6-9-2 "Option Code (deceleration stop sequence)" of Technical Document "EtherCAT Communication Specifications" (SX-DSV03307) for details.

6-3-1 Sequence upon inputting of over-travel inhibition (POT, NOT)

Set up the operating sequence when the over-travel inhibition is input (POT, NOT).

In hm mode, there are following 2 modes: the mode for performing the reverse motion after stopping in accordance with the Method that is specified and the mode in which the edge of POT/NOT is set as the home position. For details, refer to Technical Reference, SX-DSV03307" Section 6-6-5 "Homing Position Control Mode (hm mode)", EtherCAT communication specification.

The over-travel inhibition state can be notified as a warning.

For details, refer to 7-3 "Details of Protective Function" and 3-6-1 "Message at Error Occurrence" in EtherCAT Communication Specification (SX-DSV03307).

Note) Set the over-travel inhibition input (POT, NOT) correctly.

—If it is set incorrectly (NOT for the drive side in the positive direction, POT for the drive side in the negative direction, etc.), operations cannot be guaranteed.

—Install it in a position that takes into account the amount of movement before decelerating and stopping.

Note that if the torque limit or deceleration setting value is small,

the amount of movement before decelerating and stopping may increase.

(1) Relevant parameters

Class	No.	Attribute *1)	Title	Range	Unit	Function
5	04 *2)	C	Over-travel inhibit input setup	0–2	—	Set up the operation of the run-inhibition (POT, NOT) inputs. Normally it should be set to 1. 0: Deceleration stop on servo (MINAS-A6) side (sequence at time of run-inhibition input) POT -> positive direction drive inhibit, NOT -> negative direction drive inhibit. When POT is input during positive direction driving, stops the drive according to Pr5.05 Sequence at over-travel inhibit. The similar function NOT is applied in reverse direction. *3) 1: CoE (CiA402) side deceleration stop *2) *3) POT -> positive direction drive inhibit, NOT -> negative direction drive inhibit. When POT is input during positive direction driving or NOT is input during negative direction driving, EtherCAT profile slowdown defined in CoE(CiA402) works and stops it. The constants at the time of a slowdown differ for every control mode. For details, refer to 6-9-2 7) "Sequence at drive inhibition input (POT, NOT)" in Technical Reference EtherCAT Communication Specification (SX-DSV03307). 2: Deceleration stop on servo (MINAS-A6) side (Sequence at alarm) POT or NOT input activates Err 38.0 Run-inhibition input protection.
5	05 *2)	C	Sequence at over-travel inhibit	0–2	—	When Pr5.04 Over-travel inhibition = 0, specify the status during deceleration and stop after application of the over-travel inhibition (POT, NOT).
5	11	B	Torque setup for emergency stop	0–500	%	Set up the torque limit at emergency stop. When setup value is 0, the torque limit for normal operation is applied.

Class	No.	Attribute *1)	Title	Range	Unit	Function
6	98	R	Function expansion setup ⁴	-2147483648 - 2147483647	-	bit21 Extension of conditions for releasing over-travel inhibition 0: Conventional specification 1: expansion specification
6	102	B	Setting of over-travel inhibition release level	0 - 2147483647	Command unit	Sets the absolute value of the position deviation amount by which the over-travel inhibition state is released when Pr5.04 "Over-travel inhibition input setting" = 1. When the absolute value of the position deviation amount is equal to or higher than the set value, the over-travel inhibition state will not be released. *4)

*1) For parameter attribute, refer to Section 9-1.

*2) With POT allocated to SI6 or NOT allocated to SI7, and Pr 5.04 "Over-travel inhibit input setup" is set to other than 1 (CoE side deceleration stop), Err38.2 "Over-travel inhibit input protection 3" occurs.

*3) During magnet pole position estimation, and automatic linear motor setup, Err 38.0 "Over-travel inhibit input protection 1" is caused by the input of either of POT and NOT.

*4) When Pr5.04 "Over-travel inhibition input setting" \neq 1, and Pr6.102 "Setting of over-travel inhibition release level" $>$ 0, Err93.5 (Parameter setup error protection 4) occurs.

(2) Contents

- Detail of deceleration stop on servo (MINAS-A6) side (sequence at time of run-inhibition input) (Pr5.04 = 0)

Pr 5.04 *4)	Pr 5.05	During deceleration *5)		After stalling (Approx. 30 r/min or below)	
		Stopping method	Deviation	Operation after stopping	Deviation
0	Common	<ul style="list-style-type: none"> • Forcibly controls the position. *1) • Forcibly stops position command generation. *1) • bit 11 (Internal limit active) of 6041h (Statusword) is ON. 	—	<ul style="list-style-type: none"> • Control mode depends on the command. *2) • bit 11 (Internal limit active) of 6041h (Statusword) is ON. 	—
	0	• Dynamic brake (DB) *6)	Clear *3)	• Torque command=0 towards inhibited direction	Hold
	1	• Free run (DB OFF)	Clear *3)	• Torque command=0 towards inhibited direction	Hold
	2	<ul style="list-style-type: none"> • Emergency stop *4) *7) • Torque limit=Pr 5.11 	Clear *3)	• Torque limit and torque command are as usual.	Hold

- *1) During deceleration, the system is forced to perform position control, forcibly stopping the internal position command generating process.
- *2) Stop a command in over-travel inhibit direction with the over-travel inhibit input set to ON. If a command is issued in over-travel inhibit direction, the command is neglected.
- *3) During deviation clearing, the process that lets the internal command position to follow the feedback position is activated. At the instantaneous stopping and at the end of deceleration, position deviations/external scale deviations accumulated during deceleration are cleared.
- *4) Emergency stop refers to a controlled immediate stop with servo-on.
The torque command value is limited during this process by Pr 5.11 Emergency stop torque setup. In an emergency stop, normal operation is performed during the time between the input of the signal and the start of the emergency stop. If a command is stopped concurrently with the input of the signal, a torque disallowed by normal torque limitation may be output.
To allow a stop with the torque specified in the Emergency stop torque setup, continue to send the normal command at least 4 ms after the input of the signal.
- *5) Deceleration period is the time required for the running motor to speed down to 30 r/min. Once the motor speed drops below 30 r/min, it is treated as in stop state regardless of its speed.
- *6) Stopping method is Free run (DB OFF) in dynamic brake non-compatible models.
- *7) Pr6.14 "Emergency stop time at alarm" setting is invalid.

- Detail of CoE (CiA402) side deceleration stop (Pr5.04 = 1)

Pr5.04	control mode *3)	During deceleration *2)		After stalling (about 30 or less r/min)	
		Stopping method		Operation after a stopping	
1	Common	<ul style="list-style-type: none"> • Hold a servo-on condition. • Bit 11 (Internal limit active) of 6041h (Statusword) is ON. 		<ul style="list-style-type: none"> • Hold a servo-on condition. • Bit 11 (Internal limit active) of 6041h (Statusword) is ON. 	
	pp,pv,ip, csp, csv	Deceleration stop in 6085h (quick stop deceleration).		• No command acceptance towards inhibited direction *1)	
	tq,cst	Deceleration stop in 6087h (Torque slope).			

- *1) When the drive inhibit input of the ON state can stop a command to towards inhibited direction. If you give a command in the towards inhibited direction, the command will be ignored.
- *2) Deceleration period is the time required for the running motor to speed down to 30 r/min. Once the motor speed drops below 30 r/min, it is treated as in stop state regardless of its speed.

- In case of deceleration stop on servo (MINAS-A6) side (sequence at time of alarm) (Pr5.04 = 2)
Err38.0 "Over-travel inhibit input protection" occurs when POT or NOT is turned ON.
Therefore, the system operates according to Sequence at alarm, but not to this setting.

• Details on Pr6.102 "Setting of over-travel inhibition release level"

Sets the absolute value of the position deviation amount by which the over-travel inhibition state is released when Pr5.04 "Over-travel inhibition input setting" = 1. When the absolute value of the position deviation amount is equal to or higher than the set value, the over-travel inhibition state will not be released.

When Pr5.04 "Over-travel inhibition input setting" \neq 1, and Pr6.102 "Setting of over-travel inhibition release level" $>$ 0, Err93.5 (Parameter setup error protection 4) occurs.

When Pr6.98-bit 21 "Extension of conditions for releasing over-travel inhibition" = 0
(conventional specification)

POT/NOT input signal status	Pr6.102 *1)*2)	Position command direction *6)	Position deviation amount *3)	Operability *5)	
				Positive direction	Negative direction
Inputting POT	= 0	-	-	×	○
	> 0	-	\geq Pr6.102	×	×
		-	$<$ Pr6.102	×	○
Releasing POT input *4)	= 0	-	-	○	○
	> 0	-	\geq Pr6.102	×	×
		-	$<$ Pr6.102	○	○
Inputting NOT	= 0	-	-	○	×
	> 0	-	\geq Pr6.102	×	×
		-	$<$ Pr6.102	○	×
Releasing NOT input *4)	= 0	-	-	○	○
	> 0	-	\geq Pr6.102	×	×
		-	$<$ Pr6.102	○	○

In the case of Pr6.98-bit 21 "Extension of conditions for releasing over-travel inhibition" = 1
(extended specification)

POT input signal status	Pr6.102 *1)*2)	Position command direction *6)	Position deviation amount *3)	Operability *5)	
				Positive direction	Negative direction
Inputting POT	= 0	-	-	×	○
	> 0	-	\geq Pr6.102	×	×
		-	$<$ Pr6.102	×	○
Releasing POT input *4)	= 0	-	-	○	○
	> 0	-	\geq Pr6.102	×	×
		Positive direction	$<$ Pr6.102	×	×
Stop or negative direction	$<$ Pr6.102	○	○		
Inputting NOT	= 0	-	-	○	×
	> 0	-	\geq Pr6.102	×	×
		-	$<$ Pr6.102	○	×
Releasing NOT input *4)	= 0	-	-	○	○
	> 0	-	\geq Pr6.102	×	×
		Negative direction	$<$ Pr6.102	×	×
Stop or positive direction	$<$ Pr6.102	○	○		

○: Operable, ×: Not operable, -: No dependency

*1) Set Pr6.102 to 0 in the control modes except the csp control mode.

*2) Set the value in consideration of the equipment environment.

Note that if the set value is small, the over-travel inhibition state may not be released.

*3) Position deviation amount = $|607Ah(\text{Target Position}) + 60B0h(\text{Position offset}) - 6064h(\text{Position actual value})|$

*4) It means the case where the POT/NOT input is released during over-travel inhibition by POT/NOT input.

*5) Note that the motor operates when the conditions for over-travel inhibition release are satisfied.

*6) It means the direction of command change of 607Ah (Target position).

6-3-2 Sequence at Servo-Off

Operation sequence of the servo-off state is set by 605Ah(Quick stop option code), 605Bh(Shutdown option code) and 605Ch (Disable operation option code).

Deceleration function on the servo (MINAS-A6) side is activated when these objects is zero.

Deceleration function on the CoE (CiA402) side is activated when these objects is non-zero.

This section explains deceleration function on the servo (MINAS-A6) side.

Please refer to section 6-9-2 "Option Code (deceleration stop sequence)" of Technical Document "EtherCAT Communication Specifications" (SX-DSV03307) for details of deceleration function on the CoE (CiA402) side.

(1) Relevant parameters

Class	No.	Attribute *1)	Title	Range	Unit	Function
5	06	B	Sequence at Servo-Off	0-9	—	Specify the status during deceleration and after stop, after servo-off.
5	11	B	Torque setup for emergency stop	0-500	%	Set up the torque limit at emergency stop. When setup value is 0, the torque limit for normal operation is applied.

1) For parameter attribute, refer to Section 9-1.

(2) Contents

• Details of Pr 5.06 (Sequence at Servo-Off)

Pr 5.06	During deceleration *4)		After stalling (Approx.30 r/min or below)	
	Stopping method	Deviation	Operation after stopping	Deviation
Common	<ul style="list-style-type: none"> Forcibly controls the position. *1) Forcibly stops position command generation. *1) 	—	<ul style="list-style-type: none"> Forcibly controls the position. *1) Forcibly stops position command generation. *1) 	—
0,4	• Dynamic brake (DB) *6)	Clear *2)	• Dynamic brake (DB) *6)	Clear *2)
1,5	• Free run (DB OFF)	Clear *2)	• Dynamic brake (DB) *6)	Clear *2)
2,6	• Dynamic brake (DB) *6)	Clear *2)	• Free run (DB OFF)	Clear *2)
3,7	• Free run (DB OFF)	Clear *2)	• Free run (DB OFF)	Clear *2)
8	<ul style="list-style-type: none"> Emergency stop *3) *5) *7) *8) Torque limit =Pr 5.11 	Clear *2)	• Dynamic brake (DB) *6)	Clear *2)
9	<ul style="list-style-type: none"> Emergency stop *3) *5) *7) *8) Torque limit =Pr 5.11 	Clear *2)	• Free run (DB OFF)	Clear *2)

*1) During deceleration sequence or at the stop (servo OFF), the system has to control the position and to stop the generation of internal position command.

*2) During deviation clearing process, the system causes the internal command position to follow up the feedback position. When executing the interpolation feed system command after servo ON, re-set the command coordinate of the host controller. The motor may operate sharply.

*3) Emergency stop refers to a controlled immediate stop with servo-on. The torque command value is limited during this process by Pr 5.11 Emergency stop torque setup.

In an emergency stop, since normal operation is performed during the time between the servo OFF command and the start of the emergency stop, a torque disallowed by normal torque limitation may be output.

To allow a stop with the torque specified in the Emergency stop torque setup, continue to send the normal command at least 4 ms after the input of the servo OFF command.

*4) Deceleration period is the time required for the running motor to speed down to 30 r/min. Once the motor speed drops below 30 r/min, it is treated as in stop state regardless of its speed.

*5) After emergency stop start, please continue to send Servo off command (PDS command "Disable operation", "Shutdown", "Disable voltage", "Quick Stop") until the motor is stopped.

*6) Stopping method is Free run (DB OFF) in dynamic brake non-compatible models.

*7) Pr6.14 "Emergency stop time at alarm" setting is invalid.

*8) It will decelerate with dynamic brake (DB) operation instead of immediate stop during magnet pole position estimation or scale/CS direction automatic setup.

6-3-3 Sequence at main power OFF

The operation sequence at the main power supply OFF is changed with combination, such as 6007h (Abort connection option code), Pr5.07 (main power off sequence), and Pr5.09 (main power off detection time).

Basically, the deceleration function defined in CoE (CiA402) is effective until the deceleration function on the servo (MINAS-A6) side is activated by detection of the insulation of the main power AC (between L1 and L3).

- When "No action" is set by 6007h = 0, the CoE (CiA402) deceleration function does not operate, and the deceleration function on the servo (MINAS-A6) side operates.
- When the voltage between P and N decreases, Err13.0 (Main power undervoltage protection (PN)) occurs with the highest priority, causing the operation in accordance with Pr5.10 (Sequence at alarm).

This section explains deceleration function on the servo (MINAS-A6) side.

Please refer to section 6-9-2 "1) Abort connection option code (6007h)" of Technical Document "EtherCAT Communication Specifications" (SX-DSV03307) for details of deceleration function on the CoE (CiA402) side.

(1) Relevant parameters

Class	No.	Attribute *1)	Title	Range	Unit	Function
5	07	B	Sequence at main power OFF	0-9	—	Specify the status during deceleration after main power interrupt or after stoppage.
5	08	B	L/V trip selection upon main power off	0-3	—	Select LV trip or servo OFF upon occurrence of main AC power alarm. Setup the condition to detect main AC power OFF alarm when the main AC power is kept interrupted for a time longer than the time set by Pr7.14. bit 0 0: The servo off according to the setting of 6007h(Abort connection option code) or Pr5.07. 1: Trip with Err 13.1 Main power undervoltage protection. bit 1 0: Detect main AC power OFF alarm only when servo is in ON state. 1: Always detect main AC power OFF alarm. ※Please do not change the shipment value setting with V frame.
5	09	C	Detection time of main power off	20-2000 *2)	ms	Set the main power alarm detection time. When 2000 is set, main power OFF detection is disabled. ※Please do not change the shipment value setting with V frame.
5	11	B	Torque setup for emergency stop	0-500	%	Set up the torque limit at emergency stop. When setup value is 0, the torque limit for normal operation is applied
6	36	R	Dynamic brake operation input setup	0-1	—	Sets between enabling and disabling dynamic brake (DB) operation input by I/O. Note) This function is available only when the main power is turned off. 0: Disabled 1: Enabled

*1) For parameter attribute, refer to Section 9-1.

*2) To use this setting with a smaller value than the shipment value, please check matching with your power supply environment.

(2) Contents

• Details of Pr 5.07 (Sequence at main power OFF)

Pr 5.07	During deceleration *4)		After stalling (Approx.30 r/min or below)		
	Stopping method	Deviation	Operation after stopping		Deviation
			Pr6.36 = 0	Pr6.36 = 1	
Common	<ul style="list-style-type: none"> • Forcibly controls the position. *1) • Forcibly stops position command generation. *1) 	—	<ul style="list-style-type: none"> • Forcibly controls the position. *1) • Forcibly stops position command generation. *1) 		—
0,4	• Dynamic brake (DB) *5)	Clear *2)	• Dynamic brake (DB) *5)	Operation of dynamic brake is subjected to the state of dynamic brake switching input (DB-SEL). *6)	Clear *2)
1,5	• Free run (DB OFF)	Clear *2)	• Dynamic brake (DB) *5)		Clear *2)
2,6	• Dynamic brake (DB) *5)	Clear *2)	• Free run (DB OFF)		Clear *2)
3,7	• Free run (DB OFF)	Clear *2)	• Free run (DB OFF)		Clear *2)
8	<ul style="list-style-type: none"> • Emergency stop *3) *7) *8) • Torque limit =Pr 5.11 	Clear *2)	• Dynamic brake (DB) *5)		Clear *2)
9	<ul style="list-style-type: none"> • Emergency stop *3) *7) *8) • Torque limit =Pr 5.11 	Clear *2)	• Free run (DB OFF)		Clear *2)

- *1) During deceleration sequence or at the stop (main power OFF), the system must control the position and stop the generation of internal position command.
- *2) During deviation clearing process, the system causes the internal command position to follow up the feedback position. When executing the interpolation feed system command after servo ON, re-set the command coordinate of the host controller. The motor may operate sharply.
- *3) Emergency stop refers to a controlled immediate stop with servo-on. The torque command value is limited during this process by Pr 5.11 Emergency stop torque setup.
If a command is stopped concurrently with a power OFF detection, a torque disallowed by normal torque limitation may be output. To allow a stop with the torque specified in the Emergency stop torque setup, continue to send the normal command at least 4 ms after the power OFF detection.
- *4) Deceleration period is the time required for the running motor to speed down to 30 r/min.
Once the motor speed drops below 30r/min, it is treated as in stop state regardless of its speed.
- *5) Stopping method is Free run (DB OFF) in dynamic brake non-compatible models.
- *6) Dynamic brake operation input will be possible when Pr6.36 “Dynamic brake operation input setup” is effective d when main power supply is OFF. In the output signal assignment of Pr4.02 “SI3 input selection,” when connected to COM- by a connection setting, dynamic brake installed inside the amplifier will be released, and when COM- is opened, the dynamic brake installed inside the amplifier will activate.
This input will become invalid for Servo-ON, during trips, safety state or when the main power supply is switched ON and will follow the normal sequence setting.
- *7) Pr6.14 "Emergency stop time at alarm" setting is invalid.
- *8) It will decelerate with dynamic brake (DB) operation instead of immediate stop during magnet pole position estimation or scale/CS direction automatic setup.

6-3-4 Sequence at alarm

Set the operation sequence at the alarm with the exception of the communication related alarm (Err80.*, Err81.*, Err85.*, Err88.*).

Communication related alarms (Err80.*, Err81.*, Err85.*, Err88.*) information, set by 605Eh (Fault reaction option code). Please refer to section 6-9-2 "6) Fault reaction option code (605Eh)" of Technical Document "EtherCAT Communication Specifications" (SX-DSV03307) for details.

(1) Relevant parameters

Class	No.	Attribute *1)	Title	Range	Unit	Function
5	10	B	Sequence at alarm	0-7	—	Specify the status during deceleration and after stop, after occurrence of alarm.

*1) For parameter attribute, refer to Section 9-1.

(2) Contents

• Details of Pr 5.10 (Sequence at alarm)

Pr 5.10	During deceleration *4)		After stalling (Approx.30 r/min or below)	
	Stopping method	Deviation	Operation after stopping	Deviation
Common	• Forcibly controls the position. *1) • Forcibly stops position command generation. *1)	—	• Forcibly controls the position. *1) • Forcibly stops position command generation. *1)	—
0	• Dynamic brake (DB) *6)	Clear *2)	• Dynamic brake (DB) *6)	Clear *2)
1	• Free run (DB OFF)	Clear *2)	• Dynamic brake (DB) *6)	Clear *2)
2	• Dynamic brake (DB) *6)	Clear *2)	• Free run (DB OFF)	Clear *2)
3	• Free run (DB OFF)	Clear *2)	• Free run (DB OFF)	Clear *2)
4	Action A *3) • Emergency stop *3) *5) *7) • Torque limit =Pr 5.11	Clear *2)	• Dynamic brake (DB) *6)	Clear *2)
	Action B *3) • Dynamic brake (DB) *6)	Clear *2)		
5	Action A *3) • Emergency stop *3) *5) *7) • Torque limit =Pr 5.11	Clear *2)	• Dynamic brake (DB) *6)	Clear *2)
	Action B *3) • Free run (DB OFF)	Clear *2)		
6	Action A *3) • Emergency stop *3) *5) *7) • Torque limit =Pr 5.11	Clear *2)	• Free run (DB OFF)	Clear *2)
	Action B *3) • Dynamic brake (DB) *6)	Clear *2)		
7	Action A *3) • Emergency stop *3) *5) *7) • Torque limit =Pr 5.11	Clear *2)	• Free run (DB OFF)	Clear *2)
	Action B *3) • Free run (DB OFF)	Clear *2)		

- *1) During deceleration sequence or at the stop (during alarm or servo OFF), the system must control the position and stop the generation of internal position command.
- *2) During deviation clearing process, the system causes the internal command position to follow up the feedback position. When executing the interpolation feed system command after servo ON, first re-set the command coordinate of the host controller. The motor may operate sharply.
- *3) Action of A/B: When an alarm requiring emergency stop occurs, the action A is selected when the setup value in the table is set within the range 4 to 7, causing emergency stop of operation. When an alarm not requiring emergency stop occurs, it triggers dynamic braking (DB) specified by action B, or free-running. (Refer to Section 6-3-5.)
Hold the main circuit power until deceleration stop is completed.
For the alarm requiring emergency stop, refer to Section 7-1 Protective function list.
- *4) Deceleration period is the time required for the running motor to speed down to 30 r/min. Once the motor speed drops below 30 r/min, and changes its status after stoppage, it is treated as in stop state regardless of its speed.
- *5) Action B is performed when an alarm requiring emergency stop occurs while performing the dynamic braking (DB) operation with drive inhibition input sequence, sequence at the time of servo OFF or sequence at main power OFF or free-running.
- *6) Stopping method is Free run (DB OFF) in dynamic brake non-compatible models.
- *7) It will decelerate with action B specification instead of immediate stop during magnet pole position estimation or scale/CS direction automatic setup.

6-3-5 Emergency stop upon occurrence of alarm

When an alarm requiring emergency stop occurs, the system controls and immediately stops the motor.

(1) Relevant parameters

Class	No.	Attribute *1)	Title	Range	Unit	Function
5	10	B	Sequence at alarm	0-7	—	Specify the status during deceleration and after stop, after occurrence of alarm. Setting the parameter to one of 4 to 7, enables emergency stop.
5	11	B	Torque setup for emergency stop	0-500	%	Set up the torque limit at emergency stop. When setup value is 0, the torque limit for normal operation is applied
5	13	B	Over-speed level setup	0-20000	r/min	If the motor speed exceeds this setup value, Err26.0 Over-speed protection occurs. If setup value is 0, Err 26.0 will be activated with a setup value for Pr 9.10 "Maximum over-speed level". Err26.0 occurs at the setting value in Pr9.10 if this setting value exceeds the value in Pr9.10. (The parameter value is not restricted.)
6	14	B	Emergency stop time at alarm	0-1000	ms	Set up the time allowed to complete emergency stop in an alarm condition. Exceeding this time puts the system in alarm state. When setup value is 0, emergency stop is disabled and the immediate alarm stop is enabled.
6	15	B	2nd over-speed level setup	0-20000	r/min	When the motor speed exceeds this setup time during emergency stop sequence in an alarm condition, Err 26.1 2nd over-speed protection will be activated. If setup value is 0, Err 26.1 will be activated with a setup value for Pr 9.10 "Maximum over-speed level". Err26.1 occurs at the setting value in Pr9.10 if this setting value exceeds the value in Pr9.10. (The parameter value is not restricted.)
9	10	R	Maximum over-speed level	0-20000	r/min	Set up the maximum over-speed for the motor. If setup value is 0, Err 60.0 "Motor setting error protection" will be activated.

*1) For parameter attribute, refer to Section 9-1.

(2) Contents

- Emergency stop sequence upon occurrence of the alarm requiring emergency stop.

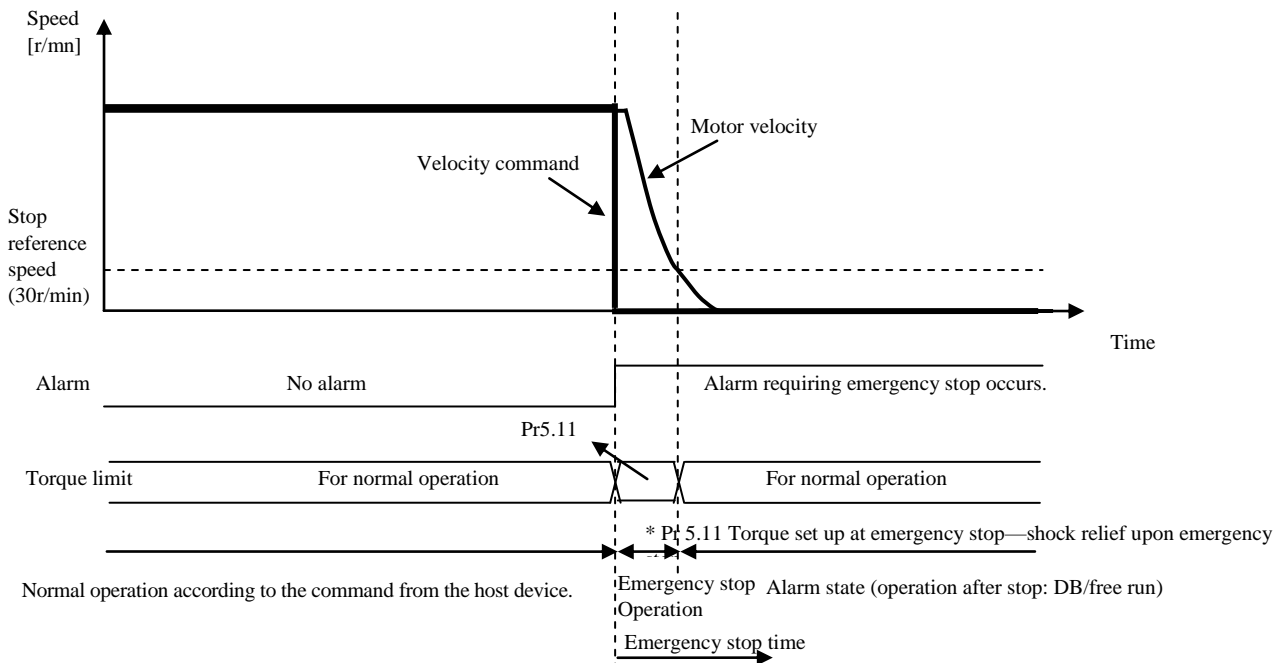

After occurrence of an alarm requiring emergency stop: when the speed has not dropped down to 30 r/min after the elapse of time set by Pr 6.14 Emergency stop time at alarm, the system generates the alarm. The system also enters the alarm state if an alarm that does not require emergency stop occurs in the driver during the sequence of the emergency stop.

- When an alarm requiring emergency stop occurs, normal operation (the normal torque limit is enabled) continues until an emergency stop is started. Therefore, if the command is interrupted during this period, the torque controlled with the normal torque limit may be output.

To stop operation with the emergency stop torque limit when an alarm requiring emergency stop occurs, continue to send the normal position command for at least 4 ms from the alarm notification.

<Bad example>

Turning on Forced alarm input (E-STOP) and stopping command at the same time

- Setting of Pr5.13 "Over-speed level setup" and Pr6.15 "2nd over-speed level"

The motor may not stop normally even if the emergency stop function is used.

For example, when the motor velocity exceeds Pr5.13 "Over-speed level setup" as shown in the figure below, the motor velocity may increase if normal control cannot be accomplished even after the start of emergency stop operation.

As a safety measure in case of this case, Err26.1 "2nd over-speed protection" is provided.

As Err26.1 is an alarm that does not require emergency stop, energization to the motor is shut off and the motor is stopped according to sequence at alarm, operation B. Set an allowable over-speed level for Pr6.15 "2nd over-speed level setup".

In addition, set Pr5.13 to a small value with a sufficient margin for Pr6.15. If the margin is insufficient or the set value is the same, both Err26.0 and Err26.1 may be detected. In this case, Err26.0 will be displayed. However, because Err26.1 is also activated internally, priority is given to the alarm that does not require emergency stop, and emergency stop is not executed.

Furthermore, if the Pr6.15 setting is smaller than the Pr5.13 setting, Err26.1 occurs prior to Err26.0.

Thus, emergency stop is not executed.

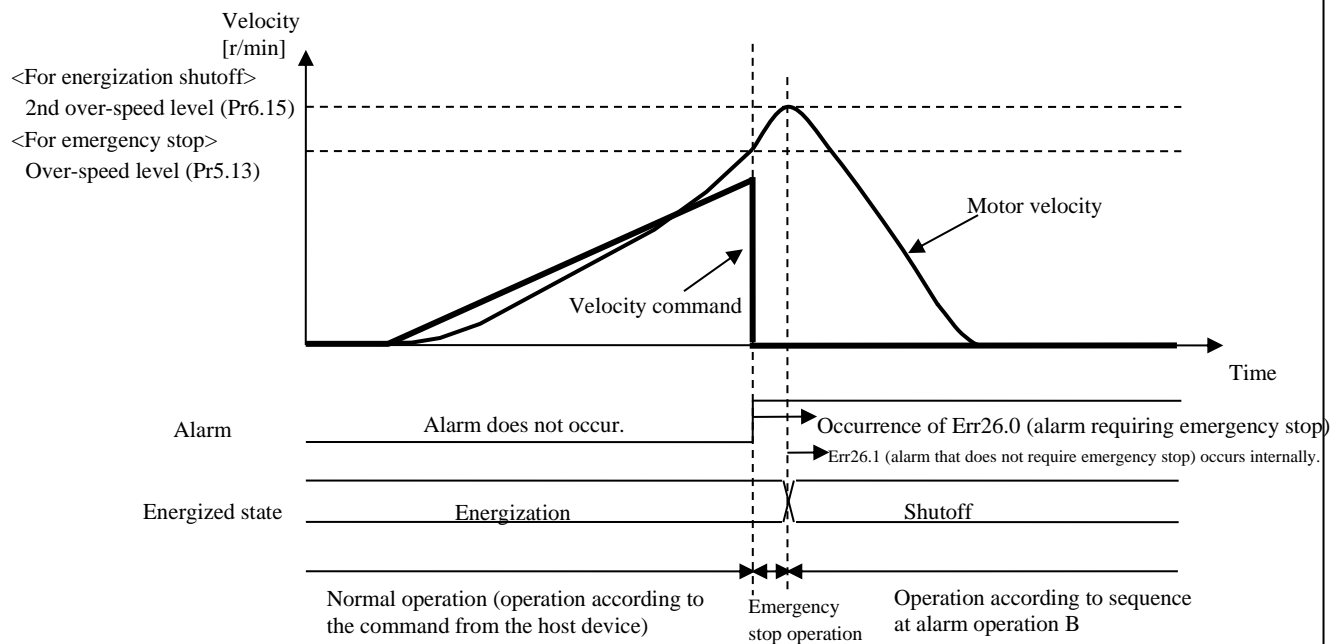

If the velocity has exceeded the value set in Pr6.15 "2nd over-speed level setup", energization is shut off and operation is performed according to sequence at alarm operation B.

6-3-6 Fall prevention function in the event of alarms/Servo-ON

6-3-6-1 Fall prevention function in the event of alarms

If the alarm requiring emergency stop has occurred, falling of the robot arm is prevented by maintaining the energization to the motor until the external brake is actually operated after the brake release output (BRK-OFF) is turned OFF.

This function can prevent a fall when alarm occurs by setting the sequence at alarm to emergency stop. This function cannot be used for alarm that does not support emergency stop.

For details of Sequence at alarm, refer to Section 6-3-4 and 6-3-5.
For details of the alarm that supports emergency stop, refer to Section 7-1.

(1) Relevant parameters

Class	No.	Attribute *1)	Title	Range	Unit	Function
5	10	B	Sequence at alarm	0-7	—	Specify the status during deceleration and after stop, after occurrence of alarm. Setting the parameter to one of 4 to 7 enables emergency stop.
6	10	B	Function expansion setup	-32768-32767	-	Set the bit related to the fall prevention function. bit10 Fall prevention function in case of alarms 0: Invalid 1: Valid To enable the fall prevention function, normally set this parameter to 1. * The least significant bit is bit0.
6	51	B	Wait time for emergency stop	0-10000	ms	Set the time to maintain the motor energization after the brake release output (BRK-OFF) is turned OFF in the event of an alarm requiring emergency stop. When the set value is 0, the fall prevention function is disabled. * This parameter is enabled even when Pr6.10 "Function expansion setup" is not set to bit10=1. To enable the fall prevention function, however, be sure to set Pr6.10 "Function expansion setup" to bit10=1.

*1) For the parameter attributes, refer to Section 9-1.

(2) Contents

- Operation of the fall prevention function in the event of the alarm requiring emergency stop

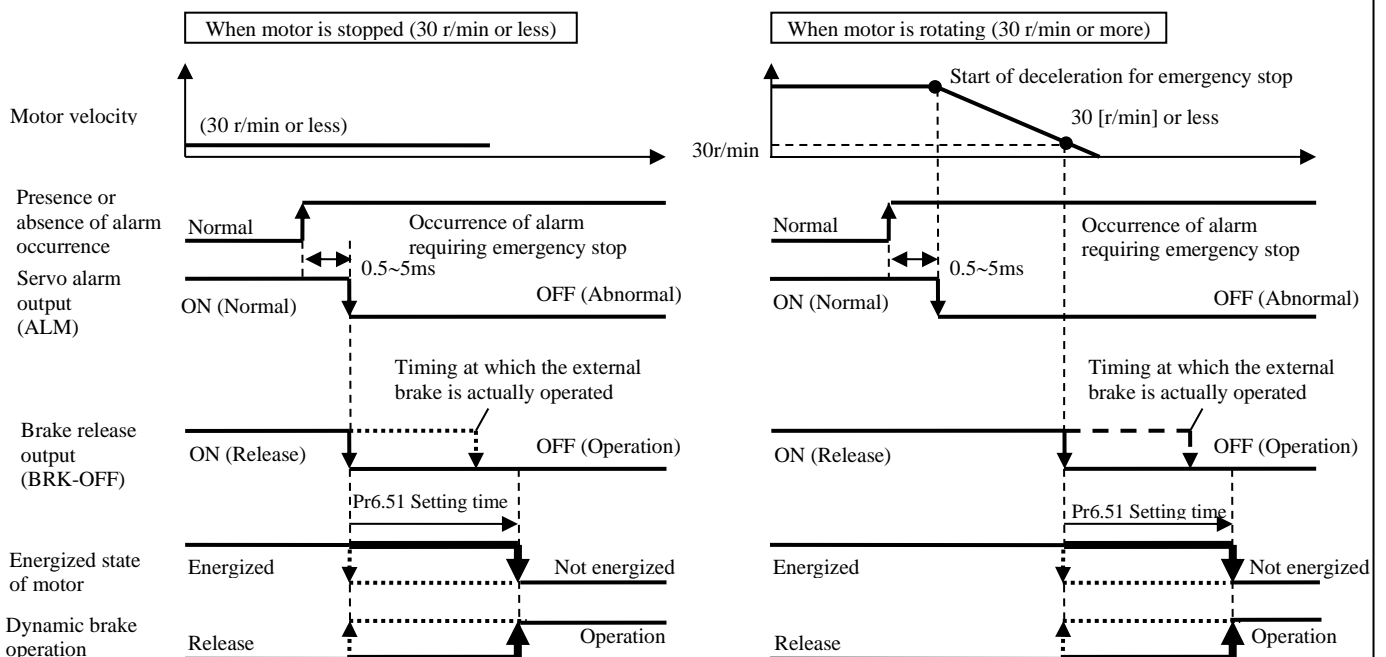

6-3-6-2 Fall prevention function in the event of Servo-ON

When the 60B2h(Torque offset) is used, enter the 60B2h(Torque offset) to torque filter at the time of servo-off, to eliminate the torque command the rise of the delay in the servo-on command input timing.
And, it will prevent the fall of the device.

(1) Relevant parameters

Class	No.	Attribute *1)	Title	Range	Unit	Function
7	24	C	Function expansion setup	-32768–32767	–	bit7 : Internal value state selection of objects 60B2h (Torque offset) in servo-off(Fall prevention function in the event of Servo-ON) 0: Clear 1: Updated with the set value of 60B2h

*1)For the parameter attributes, refer to Section 9-1.

(2) Related object

Index	Sub-Index	Name / Description	Units	Range	Data Type	Access	PDO	Op-mode	EEPROM
37B3h	00h	Torque offset filter	0.01ms	0–6400	I16	rw	NO	ALL	YES
• Set the time constant for primary delay filter for torque offset (60B2h).									
60B2h	00h	Torque offset	0.1%	-32768–32767	I16	rw	RxPDO	ALL	Yes
• Set the offset of the torque command (torque feedforward). • During slowdown in over-travel inhibition (in emergency stop), the torque feedforward level becomes 0.									

6-3-7 Slow stop function

allows the motor control to stop smoothly with the servo still remaining ON, when drive prohibited input, servo-OFF, main power OFF or emergency stop supporting alarm is detected under emergency stop setting.

(1) Applicable Range

- This function cannot be applied unless the following conditions are satisfied.

Condition for activation of slow stop function	
Control mode	• All control modes *1)
Others	• Servo-ON state • Elements other than control parameters, such as torque limit, etc. have been appropriately set, without any problems in normal operations.

*1) During emergency stop, the control mode is forcibly set to position control.

(2) Relevant parameters

Class	No.	Parameter name	Set range	Units	Functions
5	05	Sequence at over-travel inhibit	0 – 2	-	When Pr5.04 Over-travel inhibition = 0, specify the status during deceleration and stop after application of the over-travel inhibition (POT, NOT). * When the Slow Stop function is enabled, set up emergency stop
5	06	Sequence at Servo-Off	0 – 9	-	Specify the status during deceleration and after stop, after servo-off. * When the Slow Stop function is enabled, set up emergency stop
5	07	Sequence upon main power off	0 – 9	-	Specify the status during deceleration after main power interrupt or after stoppage. * When the Slow Stop function is enabled, set up emergency stop
5	10	Sequence at alarm	0 – 7	-	Specify the status during deceleration and after stop, after occurrence of alarm. * When the Slow Stop function is enabled, set up emergency stop
5	56	Slow stop deceleration time setting	0 – 10000	ms / (1000 r/min)	Sets the deceleration time under slow stop. This function will become effective when Pr6.10 “Function expansion setup” bit 15 is set to 1.
5	57	Slow stop S-shape acceleration and deceleration setting	0 – 1000	ms	Sets the S-shape time for deceleration under slow stop. This function will become effective when Pr6.10 “Function expansion setup” bit 15 is set to 1.
6	10	Function expansion setup	-32768 – 32767	-	bit 10: Fall prevention function in case of alarms 0: Invalid 1: Valid * To enable the slow stop function, set to 1. bit 15: Slow stop function 0 :Invalid 1: Valid * Set this to 0 for full-closed control.
6	14	Emergency stop time at alarm	0 – 1000	ms	Sets the allowable time for stopping when alarm is triggered for emergency stop. Exceeding this set value will trigger a forced alarm condition. In case the set value is 0 (zero), no emergency stop will be made, but an alarm condition will immediately occur. In case the slow stop function is to be used, set it to a length sufficiently longer than the maximum deceleration time, as the motor velocity will have a delay from the deceleration and stop command. This parameter is valid only for Sequence at alarm. This parameter is invalid for Sequence upon inputting of over-travel inhibition, Sequence at Servo-Off and Sequence at main power OFF. * Please refer to (3) of this section for maximum deceleration time.

*1) For parameter attributes, refer to Section 9-1.

(3) Contents

• Slow stop operation

The figure below indicates the case of slow stop operation under alarm.

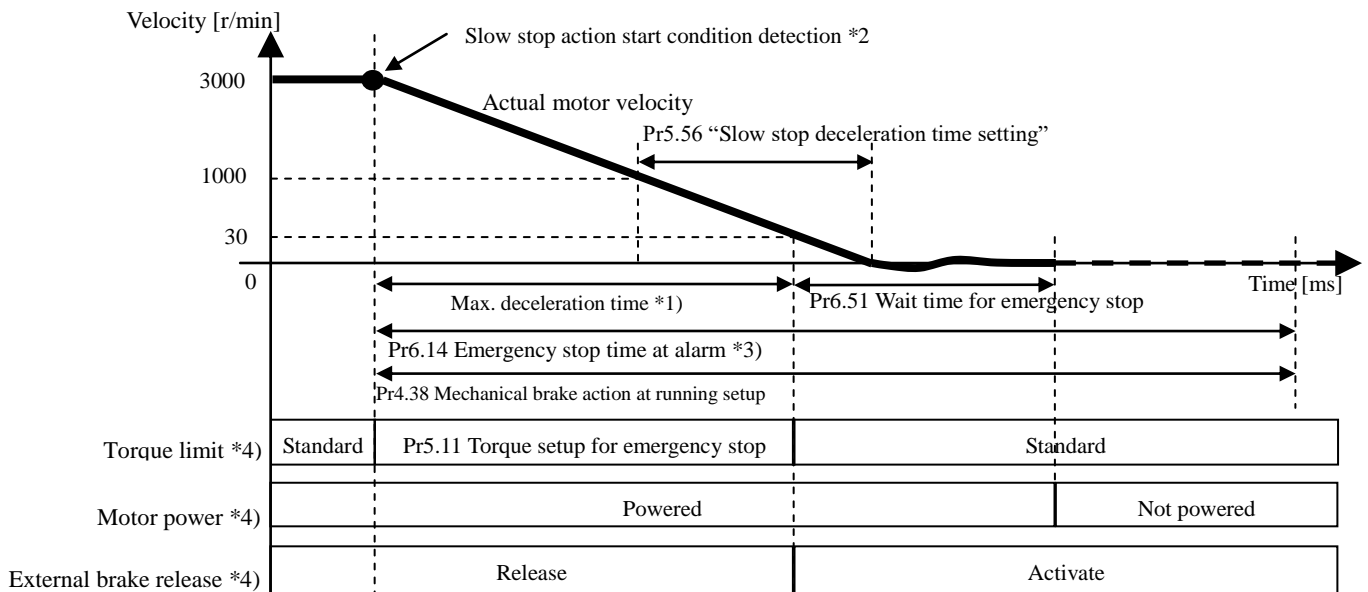

*1) The maximum deceleration time is approximately the value obtained by the following formula:
Maximum deceleration time [ms]

$$= \frac{\text{Maximum velocity under normal operation pattern [r/min]} \times \text{Pr5.56 [ms/(1000 r/min)]}}{1000} + \text{Pr5.57 [ms]}$$

*2) To be the detection of following conditions:

- Drive prohibited input with slow stop function valid setting.
 - Servo-OFF with slow stop function valid setting.
 - Main power OFF with slow stop function valid setting.
 - Emergency stop response alarm triggered with slow stop function valid setting.
- For the alarm supported emergency stop, refer to 7-1.

*3) Please set Pr6.14 "Emergency stop time at alarm" to a value that is sufficiently long in length than the completion of slow stop operation. The stop judgment under slow stop operation is based on actual velocity. Therefore, the time required for the actual deceleration may take longer than the maximum deceleration time. In the emergency stop operation from emergency stop response alarm, in case the emergency stop continuation duration exceeds Pr6.14 "Emergency stop time at alarm", an alarm state will be triggered regardless of the actual motor velocity. Furthermore, immediate alarm condition will be triggered in case emergency stop non-response alarm is generated inside the driver during emergency stop. Also, Pr6.14 "Emergency stop time at alarm" is valid only for Sequence at alarm. Pr6.14 "Emergency stop time at alarm" is invalid for Sequence upon inputting of over-travel inhibition, Sequence at Servo-Off and Sequence at main power OFF.

*4) There will be a maximum variance of about 5 [ms] in the switching timing.

Note) Please maintain the main circuit power supply during the time of decelerated stop.

- S shape processing of slow stop operation

S shape process at the time of slow stop operation can be made by setting Pr5.57. Refer to the following figure to set Pr5.57.

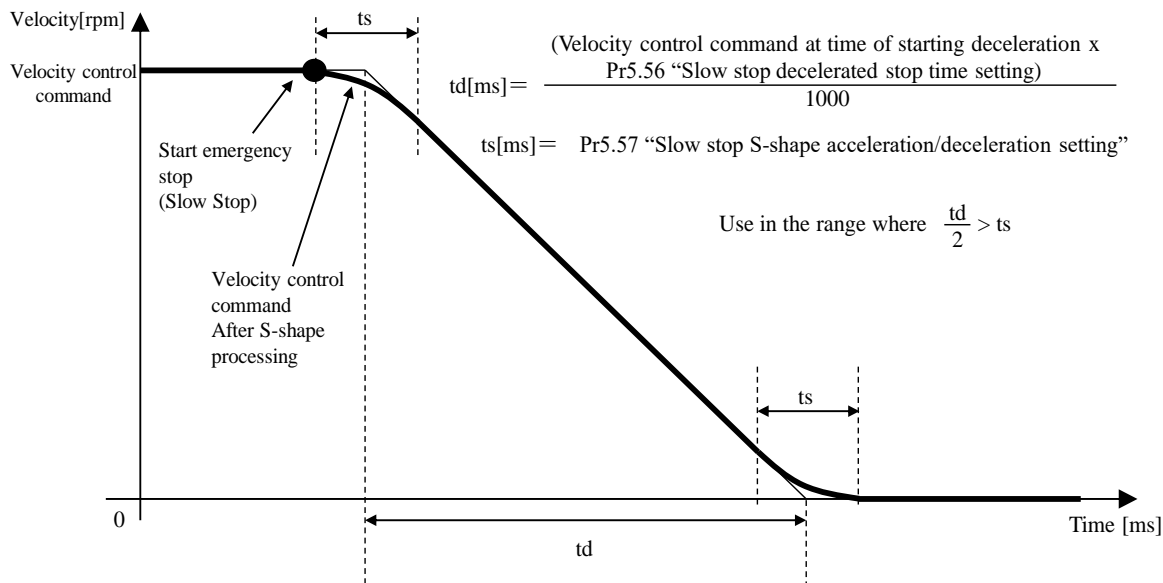

*) Velocity control command at the time of starting slow stop operation shall be calculated from the actual velocity.

- Braking distance

When Pr 5.56 and Pr5.57 has been set, the braking distance under emergency stop will increase by approximately the following formula. Please confirm its influence on the actual machine operations, when using.

1) In case of linear deceleration (Pr5.57 = 0),

[Motor type: Linear type] (Pr9.00 = 1)

Linear decelerating time [s]

$$= \frac{(\text{Velocity control command at time of starting deceleration [mm/s]} \times \text{Pr5.56 [ms/(1000mm/s)]})}{1000 \times 1000}$$

Linear deceleration brake distance [mm]

$$= \frac{(\text{Velocity control command at time of starting deceleration [mm/s]} \times \text{Linear decelerating time [s]})}{2}$$

$$= \frac{(\text{Velocity control command at time of starting deceleration [mm/s]}^2 \times \text{Pr5.56 [ms/(1000mm/s)]})}{2 \times 1000 \times 1000}$$

[Motor type: Rotary type] (Pr9.00 = 2)

Linear decelerating time [s]

$$= \frac{(\text{Velocity control command at time of starting deceleration [r/min]} \times \text{Pr5.56 [ms/(1000r/min)]})}{1000 \times 1000}$$

Linear deceleration brake distance [revolutions]

$$= \frac{(\text{Velocity control command at time of starting deceleration [r/min]} \times \text{Linear decelerating time [s]})}{60 \times 2}$$

$$= \frac{(\text{Velocity control command at time of starting deceleration [r/min]}^2 \times \text{Pr5.56 [ms/(1000r/min)]})}{60 \times 2 \times 1000 \times 1000}$$

2) For S-shape deceleration (Pr5.57 ≠ 0)

[Motor type: Linear type] (Pr9.00=1)

S-shape deceleration braking distance [mm]

$$= \text{Linear deceleration brake distance [mm]} + \frac{(\text{Velocity control command at time of starting deceleration [mm/s]} \times \text{Pr5.57 [ms]})}{1000 \times 2}$$

[Motor type: Rotary type] (Pr9.00=2)

S-shape deceleration braking distance [revolution]

$$= \text{Linear deceleration brake distance [revolution]} + \frac{(\text{Velocity control command at time of starting deceleration [r/min]} \times \text{Pr5.57 [ms]})}{60 \times 1000 \times 2}$$

Note) The above formulae are braking distances for the velocity control command only and the actual motor control delay has to be taken into account. Furthermore, in case the torque command under deceleration is restricted by immediate stop torque setting, the braking distance will not be as per the formulae indicated above.

6-4 Torque saturation protection function

If torque saturated has continued for a fixed period, an alarm can be activated.

■ Relevant parameters

Class	No.	Attribute *1)	Title	Range	Unit	Function
6	57	B	Torque saturation anomaly detection time	0-5000	ms	Set the torque saturation error protection detection time. If torque saturation erroneously occurs for a set time, Err16.1 "Torque saturation error protection" occurs. When 0 is set, the value set for Pr7.16 is enabled.
7	03	A	Output setting during torque limit	0-1	-	Sets the judgment condition for output during torque limit in the torque control mode. 0:ON in torque control mode 1:ON when torque is controlled in torque control mode
7	16	B	Frequency of torque saturation protection	0-30000	time	If torque saturated is continued during a preset frequency, Err 16.1 "Torque saturation protection" will be activated. The number of times is counted up every 0.25 ms. For example, when 30000 is set, Err16.1 occurs if the torque saturation condition continues for 7.5 seconds. The count is cleared when the torque saturation condition is removed. When the value set for Pr6.57 is other than 0, the value set for Pr6.57 is enabled.

*1) For the parameter attributes, refer to Section 9-1.

- Set both Pr6.57 and Pr7.16 to 0 to make this function disabled.
- When torque is controlled, this function is disabled and Err 16.1 will not be activated.
- If the emergency stop alarm is activated, this function is disabled and Err 16.1 will not be activated.
- During torque control, when Pr.7.03 is 0, the signal output during torque limit (TLC) is always ON. To check the torque limit during torque control, set Pr7.03 to 1.

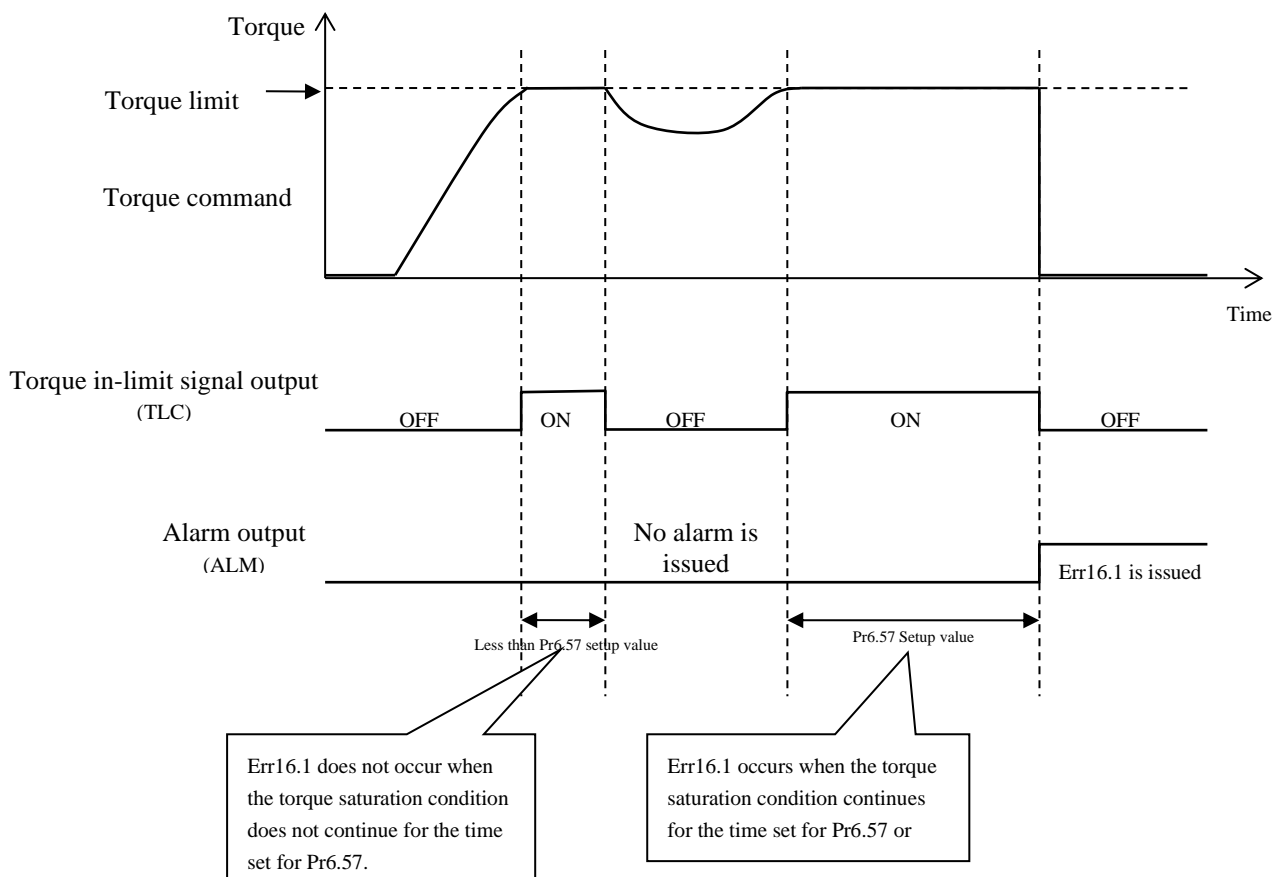

6-5 Position comparison output function

This function enables a general-purpose output or position compare terminal to output a pulse signal when the actual position passes the position set for the parameter.

(1) Specification

Trigger output	I/F	3-outputs : Photocoupler (Open collector) or 3-outputs : Line driver
	Logic	Parameter settings (The polarity can be set for each output)
	Pulse width	Parameter settings 0.1–3276.7ms (0.1ms unit)
	Delay compensation	Available
Compare source	Feedback scale (Communication)	Available
	Feedback scale (A,B-phase)	Available
Compare value	Setting points	8-points
	Setting range	Signed 32bit

(2) Applicable Range

- This function cannot be applied unless the following conditions are satisfied.

Operating conditions for position comparison output function	
Control mode	• Available in all control modes
Other	• EtherCAT communication has been established. (ESM state is more than PreOP) • Home position return has been completed. • The elements other than control parameters are correctly set, assuring that the motor can run smoothly.

(3) Caution

Position compare output accuracy may deteriorate depending on feedback speed [pulse/s], or the relationship between feedback scale resolution and motor speed.

(4) Relevant parameters

Class	No.	Attribute *1)	Title	Range	Unit	Function
4	44	R	Position comparison output pulse width setting	0-32767	0.1 ms	Set the pulse width of position comparison output. No pulse is output when 0 is set.
4	45	R	Position comparison output polarity selection	0-7	-	Set the polarity of position comparison output by bit setup for each output terminal. • Setup bits *2) *3) bit0: SO1 , OCMP1 bit1: SO2 , OCMP2 bit2: SO3 , OCMP3 • Setup values of Each setting bit 0: The output photocoupler is turned ON for SO1 to 3 and is set to L level for OCMP1 to 3, respectively, during pulse output. 1: The output photocoupler is turned OFF for SO1 to 3 and is set to H level for OCMP1 to 3, respectively, during pulse output. Basically, use this function as 0. ※Do not use SO3 with V frame.
4	47	R	Pulse output selection	0-1	-	Select the signal to be output from the feedback scale output terminal or position comparison output terminal. *3) 0: Feedback scale output signal(OA, OB) 1: Position comparison output signal(OCMP1~3)
4	48	A	Position comparison value 1	-2147483648- 2147483647	Command unit	Set the comparison value for position comparison value 1.
4	49	A	Position comparison value 2	-2147483648- 2147483647	Command unit	Set the comparison value for position comparison value 2.
4	50	A	Position comparison value 3	-2147483648- 2147483647	Command unit	Set the comparison value for position comparison value 3.
4	51	A	Position comparison value 4	-2147483648- 2147483647	Command unit	Set the comparison value for position comparison value 4.
4	52	A	Position comparison value 5	-2147483648- 2147483647	Command unit	Set the comparison value for position comparison value 5.
4	53	A	Position comparison value 6	-2147483648- 2147483647	Command unit	Set the comparison value for position comparison value 6.
4	54	A	Position comparison value 7	-2147483648- 2147483647	Command unit	Set the comparison value for position comparison value 7.
4	55	A	Position comparison value 8	-2147483648- 2147483647	Command unit	Set the comparison value for position comparison value 8.
4	56	R	Position comparison output delay compensation amount	-32768- 32767	0.1 us	Compensate the delay in the position comparison output signaled by the circuit.
4	57	R	Position comparison output assignment setting	-2147483648- 2147483647	-	Set the output terminals corresponding to position comparison values 1 to 8 by bit setup. Multiple position comparison values can be set up on one output terminal. • Setup bits bit0 to 3 : Position comparison value 1 bit4 to 7 : Position comparison value 2 bit8 to 11 : Position comparison value 3 bit12 to 15 : Position comparison value 4 bit16 to 19 : Position comparison value 5 bit20 to 23 : Position comparison value 6 bit24 to 27 : Position comparison value 7 bit28 to 31 : Position comparison value 8 • Setup values of Each setting bit *2) *3) 0000b : Output disabled 0001b : Allocated to SO1 , OCMP1 0010b : Allocated to SO2 , OCMP2 0011b : Allocated to SO3 , OCMP3 Other than above : For manufacturer's use (Do not set.) ※Do not use SO3 with V frame.
5	94	A	Position comparison Output condition setting	0~2	-	Selects the operation direction in which position comparison output is enabled. 0: Enabled in positive and negative directions 1: Enabled only for positive direction operation 2: Enabled only for negative direction operation

*1) For parameter attributes, see Section 9-1.

*2) When general-purpose outputs (SO1 to SO3) are used as position comparison outputs (CMP-OUT), allocate the position comparison output (CMP-OUT) to Pr4.10 to Pr4.12 for all control modes.
* Position compare outputs cannot be monitored from PANATERM and EtherCAT communications.

*3) When the feedback scale output signals (OA, OB) are used as position comparison outputs (CMP-OUT), set Pr4.47 to "1".

(5) Operation

- When the actual position of the feedback scale passes a position comparison value (Pr4.48 to Pr4.55), a pulse with the time width set for the position comparison output pulse width setting (Pr4.44) is output.

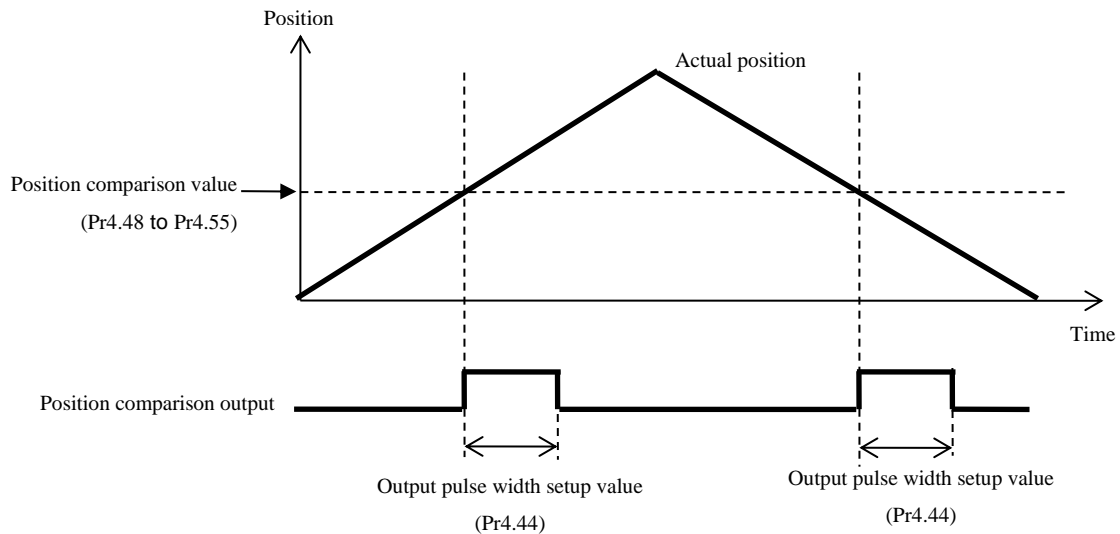

- A pulse is output when the position comparison value is passed and the relationship in size changes, irrespective of the passing direction of the feedback scale position.
- Multiple position comparison values can be set up on one position comparison output.
- If, during pulse output, the feedback scale position or external scale position passes the position comparison value in situations such as when the operation direction is reversed or multiple position comparison values are set, the ON status of pulse output continues throughout the period between the point of the last passage and the output pulse width setup value.

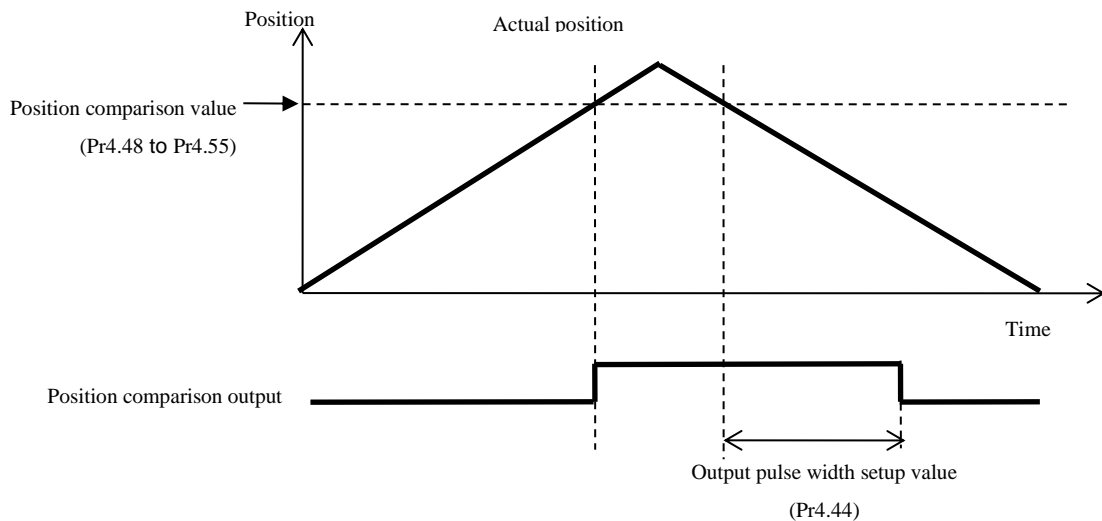

- Also when the position stops at the same position as the position comparison value, the pulse is output only once as with the case of passage.

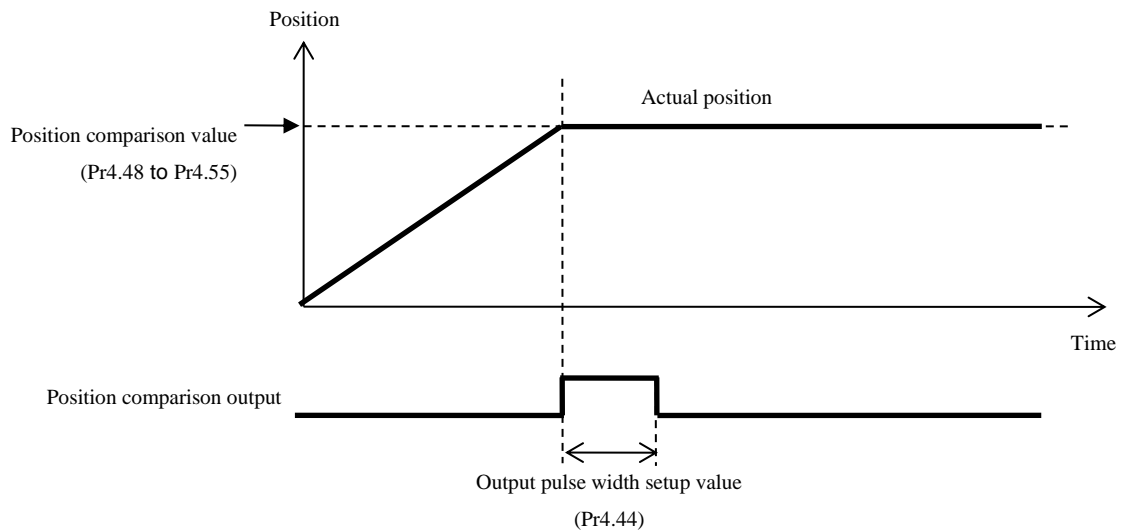

- Controls pulse output in response to bit21 “CMP-OUT INH” of 60FEh (Digital outputs). For more information on “CMP-OUT INH”, see 6-9-3-2 “Digital outputs (60FEh)” in the Technical Document, EtherCAT Communication Specifications (SX-DSV03307).

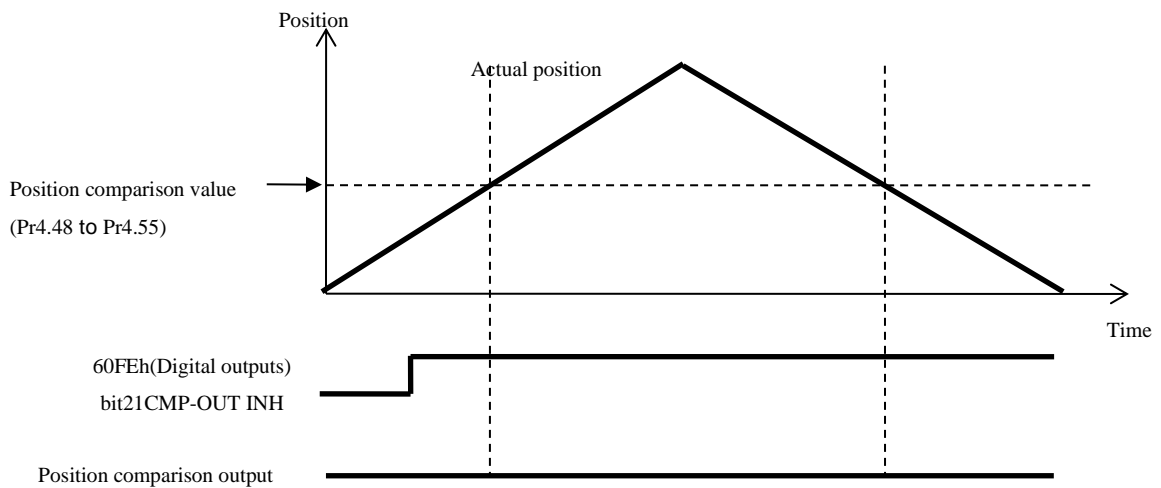

If bit21 “CMP-OUT INH” of 60FEh (Digital outputs) is enabled (= Disables position comparison output) during pulse output, pulse output continues turning ON between the time period from the last passage to the output pulse width setup value.

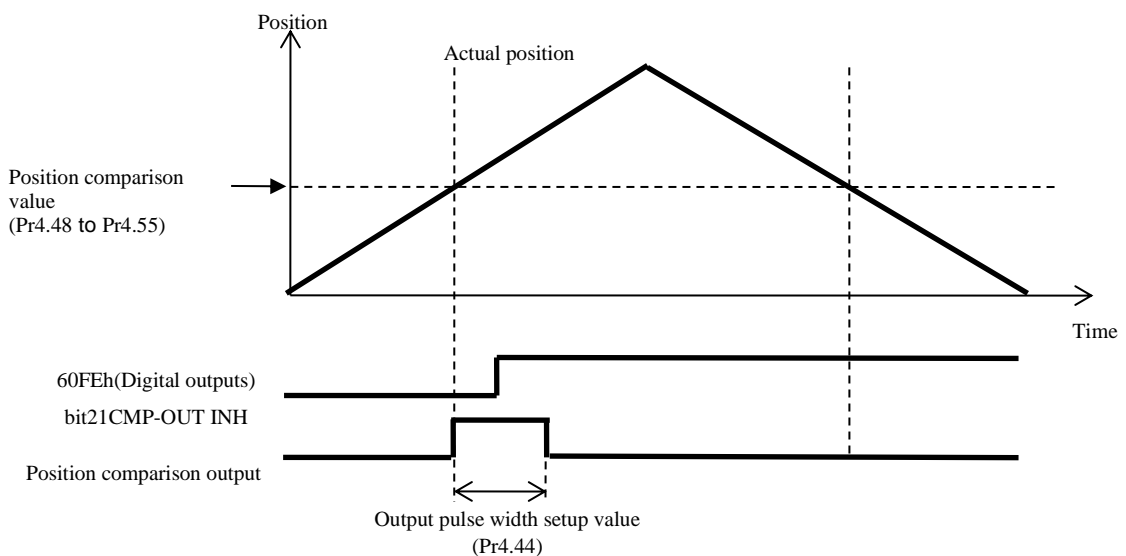

- Outputs the pulse according to the operation direction set up with Pr5.94 “Position comparison output condition setting” .

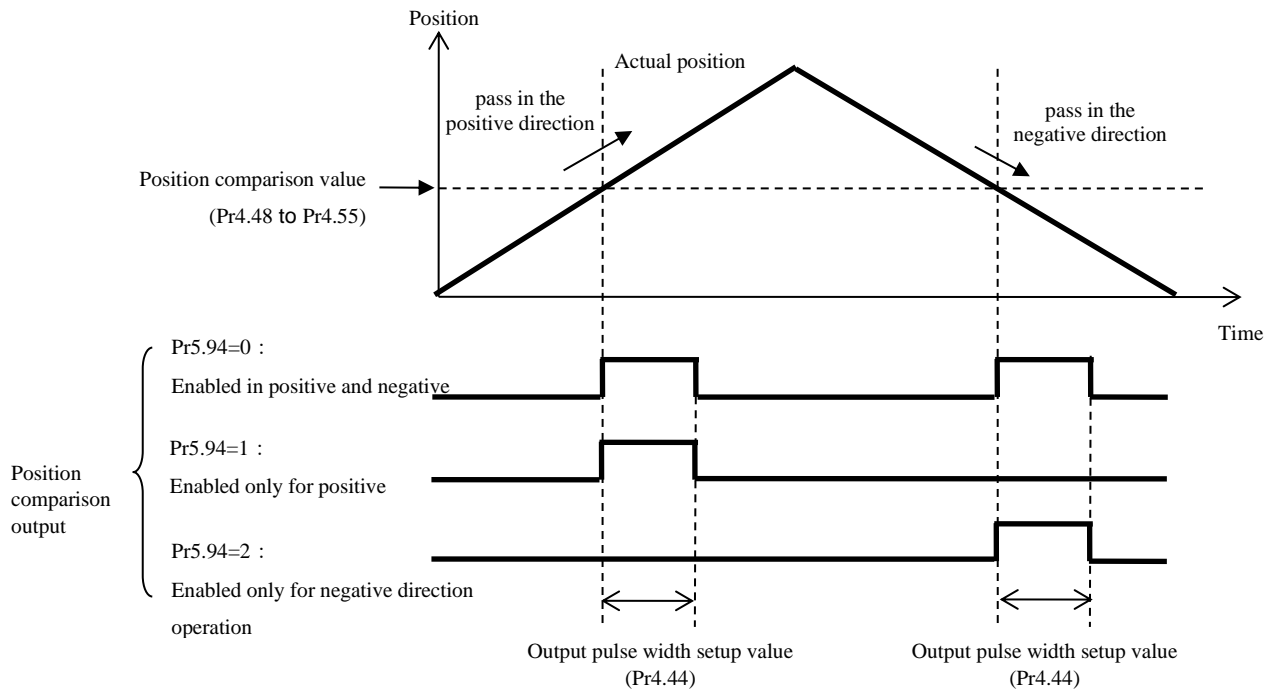

- The position comparison output function sends outputs while automatically compensating, based on the previous motor speed, the errors caused by the time of delay of feedback scale serial communication, etc. In addition, the amount of correction can also be adjusted with the setup of the amount of position comparison output delay correction (Pr4.56). For example, when using the position comparison output function as an operation trigger for the external device such as a camera, Pr4.56 can be set according to the delay time between the external device receiving the position comparison output signal and starting operation.

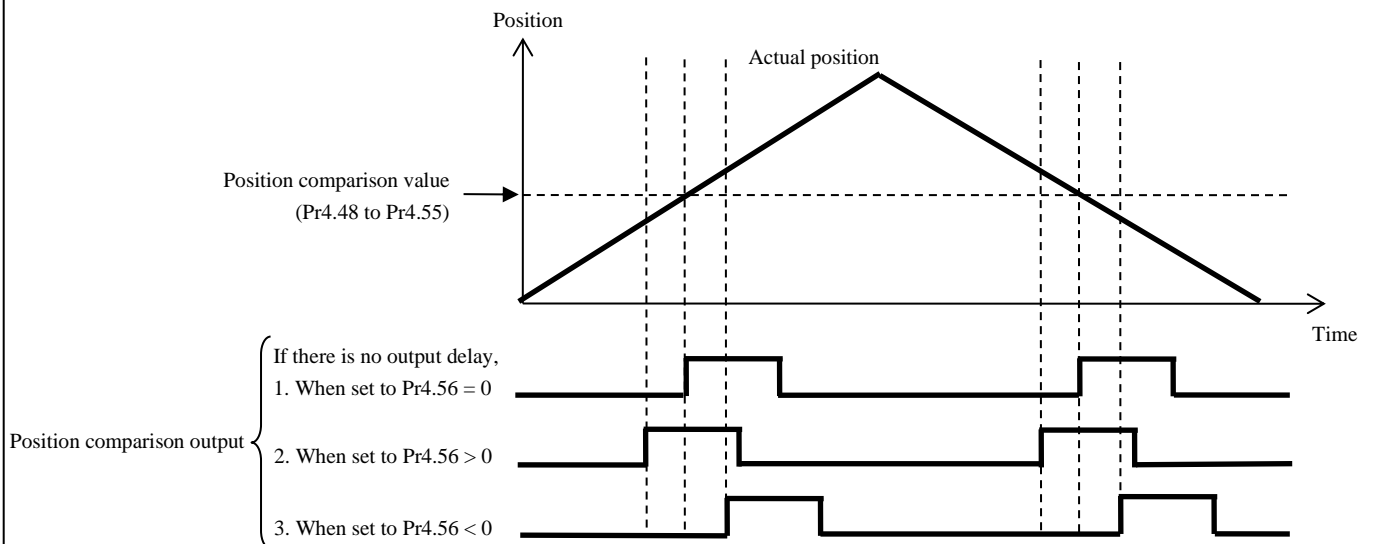

6-6 Deterioration diagnosis warning function

This is a function to check the changes in motor and connected equipment characteristics to output deterioration diagnosis warning.

(1) Relevant parameters

Class	No.	Attribute *1)	Parameter name	Set range	Units	Functions
5	66	A	Deterioration diagnosis convergence judgment time	0–10000	0.1s	Sets the time required to deem that real-time auto tuning load characteristics estimate has converged when deterioration diagnosis warning function is activated (Pr6.97 bit 1 = 1). When the set value is 0, it will be set automatically inside the driver in accordance with Pr6.31 (real-time auto tuning estimation velocity). * When Pr6.31 (real-time auto tuning estimation velocity) = 0, the deterioration diagnosis warning judgment for load characteristics estimate will be invalid.
5	67	A	Deterioration diagnosis inertia ratio upper limit value	0–10000	%	Sets the upper and lower limit values for inertia ratio estimate in deterioration diagnosis judgment when deterioration diagnosis warning is valid (Pr6.97 bit 1 = 1) and load characteristics estimate convergence has been completed. * The set resolution shall be in units of 0.2%.
5	68	A	Deterioration diagnosis inertia ratio lower limit value	0–10000	%	
5	69	A	Deterioration diagnosis unbalanced load upper limit value	-1000–1000	0.1%	Sets the upper and lower limit values for unbalanced load estimate in deterioration diagnosis judgment when deterioration diagnosis warning is valid (Pr6.97 bit 1 = 1) and load characteristics estimate convergence has been completed. * The set resolution shall be in units of 0.2%.
5	70	A	Deterioration diagnosis unbalanced load lower limit value	-1000–1000	0.1%	
5	71	A	Deterioration diagnosis dynamic friction upper limit value	-1000–1000	0.1%	Sets the upper and lower limit values for dynamic friction estimate in deterioration diagnosis judgment when deterioration diagnosis warning is valid (Pr6.97 bit 1 = 1) and load characteristics estimate convergence has been completed. * The set resolution shall be in units of 0.2%.
5	72	A	Deterioration diagnosis dynamic friction lower limit value	-1000–1000	0.1%	
5	73	A	Deterioration diagnosis viscous friction upper limit value	0–10000	0.1%/ (10000 r/min)	Sets the upper and lower limit values for viscous friction coefficient estimate in deterioration diagnosis judgment when deterioration diagnosis warning is valid (Pr6.97 bit 1 = 1) and load characteristics estimate convergence has been completed. * The set resolution shall be in units of 0.2%.
5	74	A	Deterioration diagnosis viscous friction lower limit value	0–10000	0.1%/ (10000 r/min)	
5	75	A	Deterioration diagnosis velocity setting	-20000 –20000	r/min	Outputs deterioration diagnosis velocity output (V-DIAG) when deterioration diagnosis warning is valid (Pr6.97 bit 1 = 1) and the motor velocity is within the range of Pr5.75 ± Pr4.35 (velocity coinciding width). * Deterioration diagnosis velocity output has a 10 [r/min] hysteresis.
5	76	A	Deterioration diagnosis torque average time	0–10000	ms	Sets time required to calculate the torque command average value when deterioration diagnosis warning is valid (Pr6.97 bit 1 = 1) and diagnosis velocity output (V-DIAG) is ON. * Time from diagnosis velocity output (V-DIAG) ON to the start judgment for upper and lower value of torque command average value is also a part of the set time for this parameter. *If the setting value is 0, the torque command average value is not calculated.
5	77	A	Deterioration diagnosis torque upper limit value	-1000–1000	0.1%	Sets the upper and lower limit values of torque command average value when deterioration diagnosis warning is valid (Pr6.97 bit 1 = 1) and deterioration diagnosis velocity output (V-DIAG) is ON.
5	78	A	Deterioration diagnosis torque lower limit value	-1000–1000	0.1%	
6	97	B	Function expansion setup 3	-2147483648 – 2147483647	-	Bit 1 to set the deterioration diagnosis warning function to valid or invalid 0: invalid, 1: valid

*1) For parameter attribute, refer to Section 9-1.

(2) Cautions

- When the upper limit value is set to the maximum value, the upper limit judgment will become invalid.
- When the lower limit value is set to the minimum value, the lower limit judgment will become invalid.
- In case upper limit value \leq lower limit value, then both the upper limit and lower limit judgment will become invalid.
- Due to the USB communication delay, the average torque command value acquired via USB is compared with the actual value inside the amplifier
It may be different. (0 may be displayed even when the actual value is not 0.)

(3) Contents

- Deterioration diagnosis warning functions for the following five types of data can be used by setting bit 1 of Pr6.97 “Function expansion setup 3” to 1.
 - Inertia ratio (3-1-1)
 - Unbalanced load (3-1-2)
 - Dynamic friction (3-1-3)
 - Viscous friction (3-1-4)
 - Torque command average value (3-2)

(3-1) Deterioration diagnosis warning for load characteristic estimates (Inertia ratio, Unbalanced load, Dynamic friction, Viscous friction)

- Deterioration diagnosis warning judgment for four load characteristics estimates (inertia ratio, unbalanced load, dynamic friction, and viscous friction coefficient) can be used in case real-time auto tuning load characteristics estimate is valid (refer to items 5-1-1, 5-1-3, 5-1-4).
- The abovementioned deterioration diagnosis warning judgment will become effective when the required operational conditions for load characteristics estimate has continued in total for Pr5.66 “deterioration diagnosis convergence judgment time” or more, and the load characteristics estimate has converged. Once it has become effective, it will remain in effect until Pr6.97 bit 1 is set to 0 (invalid) or the real-time auto tuning load characteristics estimate is invalidated.
- For each load characteristics estimate value, its upper and lower limit value can be set by the parameters as indicated in the following table. In case the load characteristic estimates has exceeded the upper or lower limit values for changes in load characteristics estimate, it generates deterioration diagnostic warning WngAC.

	(3-1-1)	(3-1-2)	(3-1-3)	(3-1-4)
	Inertia ratio	Unbalanced load	Dynamic friction	Viscous friction
Upper limit value	Pr5.67	Pr5.69	Pr5.71	Pr5.73
Lower limit value	Pr5.68	Pr5.70	Pr5.72	Pr5.74

* Set resolution for the upper and lower limit of friction torque estimates (unbalanced load, dynamic friction, and viscous friction coefficient) shall be in units of 0.2%.

* In case Pr6.31 “Real-time auto-tuning estimation speed” is set to 0 and is estimate stopped from the start or before the load characteristics estimate results has been confirmed, deterioration diagnosis warning judgment will become invalid even if real-time auto tuning load characteristics estimate is valid.

(3-2) Deterioration diagnosis warning for constant velocity torque command average value

- Deterioration diagnosis velocity output (V-DIAG) is ON when the motor velocity is within the range of Pr4.35 “Speed coincidence range” of Pr5.75 “Deterioration diagnosis velocity setting”.
- When deterioration diagnosis velocity output (V-DIAG) is turned ON, torque command average calculation will start and after lapse of the set time of Pr5.76, deterioration diagnosis judgment by torque command average will become effective. This will continue while deterioration diagnosis velocity output (V-DIAG) remains output ON, however will return to invalid condition when the output is turned OFF.
- The upper limit and lower limit values for torque command average can be set by parameters Pr5.77 and 5.78 respectively. Deterioration diagnostic warning WngAC is generated in case these upper or lower limit values have been exceeded for changes in the load characteristic estimates.

i) Example when deterioration diagnosis warning for torque command average value is not generated

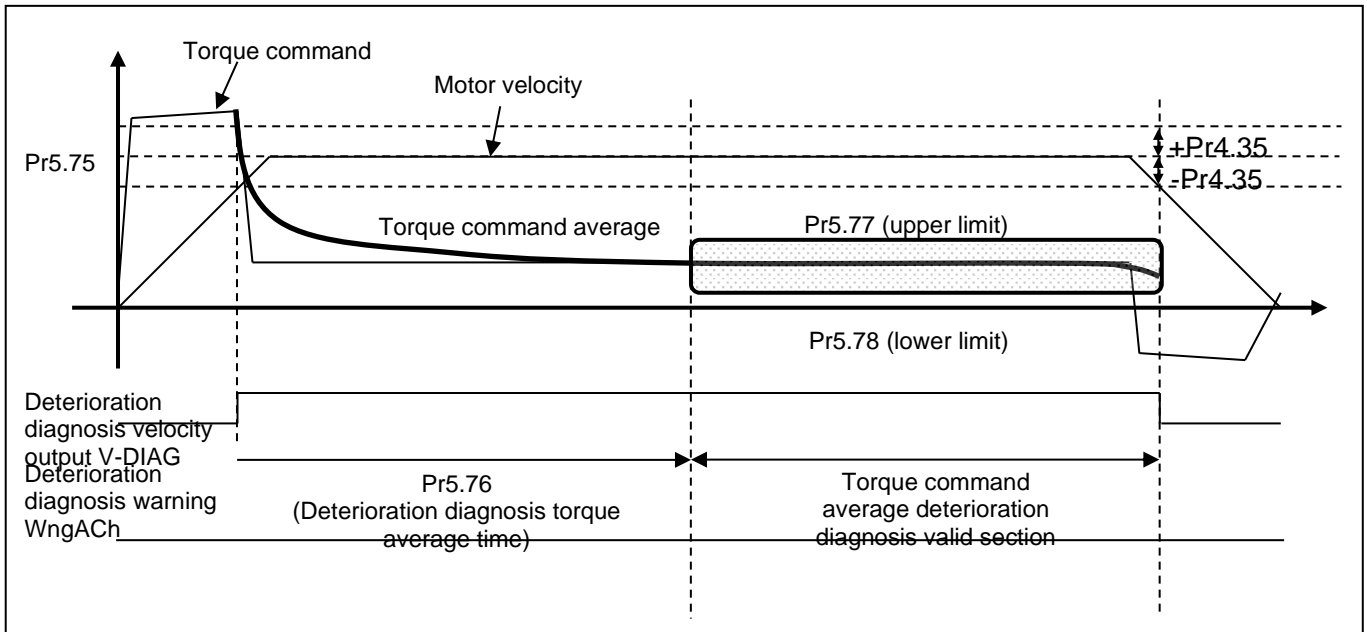

ii) Example when deterioration diagnosis warning for torque command average value is generated

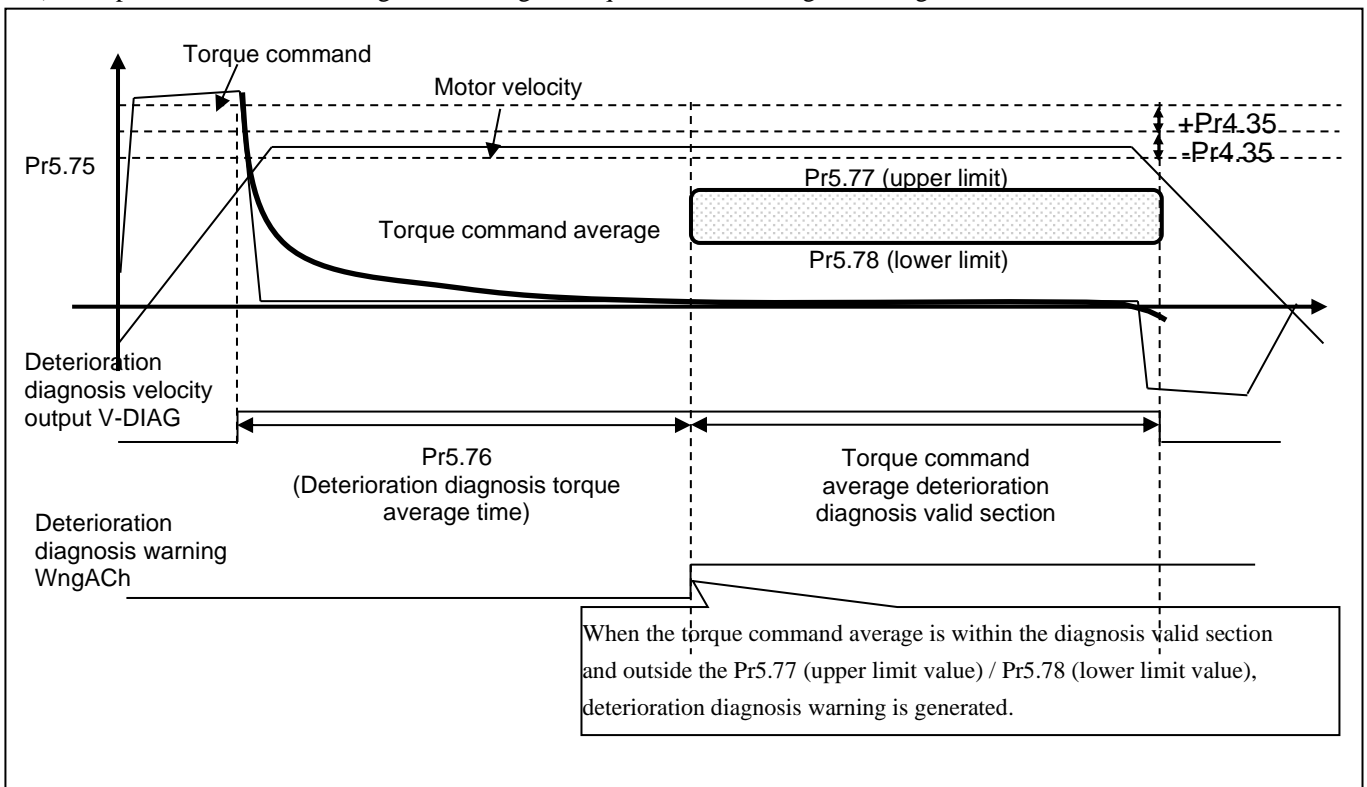

6-7 Retracting operation function

When one of the retracting operation activation conditions is established, a retracting operation is performed at the speed and movement amount set up by the relevant parameters.
After the retracting operation is completed, an alarm is generated.

(1) Applicable Range

This function operates under the following conditions.

Conditions under which the retracting operation function is activated	
Control mode	<ul style="list-style-type: none"> • Can be used in all control modes Note) Do not switch the control mode during an retracting operation.
Others	<ul style="list-style-type: none"> • The software version shall be later than the function expanded version 1 and later (Ver1.02 and later) • Synchronization mode is DC or SM2. • An activation condition described in “(5) Retracting operation details” shall be established. • An activation cancellation condition described in “(5) Retracting operation details” shall not be established.

(2) Cautions

- To confirm that retracting is in operation, check the 60FDh (Digital inputs) bit 25 “RET status [RET-STAT]”.
*1) 0: Retreat operation not started/completed, 1: Retreat operation being executed
- If a retracting operation is activated during a return to origin operation, the operation is not guaranteed.
- If a return to origin operation is activated during a retracting operation, the operation is not guaranteed.
- Make sure that the origin position and the RET input position do not overlap.
- During a retracting operation, 6060h (Mode of operation) is ignored, and the control mode is forced to be pp mode (6061h (Mode of operation display) = 1 (pp)).
Therefore, note that application of various filters and allocation of input and output signals during retracting operations conform to those for position control.
In addition, on retracting operation completion, 6061h (Mode of operation display) is restored back to the value at the time of retracting operation start.
When the control mode should be changed, wait until the retracting operation is completed and 6061h (Mode of operation display) is restored back to the value at the time of retracting operation start, and then change 6060h (Mode of operation).
If the control mode is switched during a retracting operation, the operation is not guaranteed.
- Check that retracting operation is being executed at 60FDh (Digital inputs) bit25.
- In the Incremental mode, returning to origin is uncompleted (homing attained = 0) after Err87.1, or Err87.3 occurrence. After clearing the alarm, return to origin should be performed again.
- Pr8.17 (Relative movement of retracting operation) is a signed data. Caution is required in the direction of the retracting operation.
To ensure safety, check the direction of retracting operation while setting Pr8.17 to a small value before implementing initial setup.
- The state of PDS will be Fault reaction active during retracting operation, and external commands will not be accepted. For details, please refer to (5-7) “Retracting operation suspension conditions.”

(3) Relevant parameters

Class	No.	Attribute *1)	Title	Range	Unit	Function																		
5	08	B	LV trip selection at main power supply OFF	0-3	-	Select whether LV trip or servo off is executed at main power supply alarm. It also sets up the conditions for main power supply off warning detection when the state in which the main power supply is cut off continues for the period set in Pr7.14 or longer. bit0 0 : Servo off is executed according to the setting in Pr5.07 or 6007h (Abort connection option code). 1 : Err13.1 "Main power undervoltage protection" detection *4) bit1 0 : Only servo on state is detected for main power supply off warning 1 : Main power supply off warning is constantly detected																		
5	09	C	Main power supply off detection time	20-2000 *3)	ms	Set the main power supply alarm detection period. Main power supply off detection is disabled when the setting value is 2000.																		
6	85	C	Retracting operation condition setting	-32768- 32767	-	Select retracting operation activation and stop determination conditions. bit 3-0: Other than communication 0: Retracting operation by I/O disablement 1: RET input 2: RET/HOME input 3: Main power supply off detection *5) 4 to 15: Err87.3 occurs due to a setting error bit 7-4: Communication-related 0: Retracting operation disablement due to the establishment of one of the occurrence conditions of Err80.4 (PDO watchdog error protection), Err80.7 (Synchronization signal error protection), and Err85.2 (Lost link detection error protection) (If the condition is established, Err80.4, Err80.7, or Err85.2 occurs and the speed is reduced according to Fault reaction option code) 1: Establishment of one of the occurrence conditions of Err80.4, Err80.7, and Err85.2 2 to 15: Err87.3 occurs due to a setting error bit 9-8: Retracting operation stop determination condition <table border="1" data-bbox="842 1249 1433 1433"> <thead> <tr> <th>bit9</th> <th>bit8</th> <th>Position command transfer completion</th> <th>Positioning (target reached)*1)</th> </tr> </thead> <tbody> <tr> <td>0</td> <td>0</td> <td>Pre-filter determination</td> <td rowspan="2">Determination invalid</td> </tr> <tr> <td>0</td> <td>1</td> <td>Post-filter determination</td> </tr> <tr> <td>1</td> <td>0</td> <td>Pre-filter determination</td> <td rowspan="2">Determination valid</td> </tr> <tr> <td>1</td> <td>1</td> <td>Post-filter determination</td> </tr> </tbody> </table> *1)6041h (Statusword) bit 10 is used Example) In the case of bit 8=0 and bit 9=0, determination is made to stop retracting operation under the following conditions. - Determine completion of position command payment with value before filter - Positioning determination is invalid bit 15-10: Setting error if other than 0. Err87.3 occurs	bit9	bit8	Position command transfer completion	Positioning (target reached)*1)	0	0	Pre-filter determination	Determination invalid	0	1	Post-filter determination	1	0	Pre-filter determination	Determination valid	1	1	Post-filter determination
bit9	bit8	Position command transfer completion	Positioning (target reached)*1)																					
0	0	Pre-filter determination	Determination invalid																					
0	1	Post-filter determination																						
1	0	Pre-filter determination	Determination valid																					
1	1	Post-filter determination																						
6	86	C	Retracting operation alarm setting	0-7	-	Set retracting operation alarm clear attributes. bit 0: Err87.1 (Retracting operation completion (I/O)) 0: Not clearable, 1: Clearable bit 1: Err87.2 (Retracting operation completion (communication)) 0: Not clearable, 1: Clearable bit2: Err87.3 (Retracting operation error) 0: Not clearable, 1: Clearable																		

(To be continued)

Class	No.	Attribute *1)	Title	Range	Unit	Function
8	01	B	Profile linear acceleration constant	1-429496	10000 command unit/s ²	Set the acceleration of retracting operations. Make sure that this is set before operation activation.
8	04	B	Profile linear deceleration constant	1-429496	10000 command unit/s ²	Set the deceleration of retracting operations. Make sure that this is set before operation activation.
8	17	B	Relative movement of retracting operation *2)	-2147483647 - 2147483647	command unit	Set the amount of movement at the time of retracting operations based on the pre-filter command position. If the movement amount is 0 after the processing by the electronic gear, after emergency stop, no retracting operation is performed and Err87.1 or Err87.2 occurs. Make sure that this is set before operation activation. * This is a signed data. Caution is required on the direction of the retracting operation.
8	18	B	Retracting operation speed	0- 2147483647	command unit/s	Set the speed of retracting operations. If 0 is set for this parameter, 1 is set internally. The maximum value is set internally to a smaller value between 6080h (Max motor speed) and the maximum motor speed. Make sure that this is set before operation activation.

*1) For parameter attribute, refer to Section 9-1.

*2) It is the relative amount of travel with the commanded position before the filter used as reference.

*3) Please check the match in your power supply environment if you wish to use the system with the setting value changed from the shipment value.

*4) Err13.1 "Main power undervoltage protection (AC off detection)" will not occur when retracting operation is executed using the main power supply off as the trigger.

*5) To use main power supply off as the trigger, set Pr5.09 "Main power supply off detection time" to a value other than 2000. Detection of main power supply off itself will be disabled when Pr5.09 is 2000.

Please do not use this setting value with V frame.

(4) Related alarms

Error No.		Alarm	Causes	Measures
Main	Sub			
33	0	Duplicated input allocation error 1 protection	Input signals (SI1, SI2, SI3, SI4) are assigned with two functions.	Allocate correct function to each connector pin.
33	1	Duplicated input allocation error 2 protection	Input signals (SI5, SI6, SI7, SI8) are assigned with two functions.	Allocate correct function to each connector pin.
80	4	PDO watchdog error protection	During PDO communication (SafeOP or OP state), bit10 of AL Event Request(0220h) did not turn on within the time is set ESC register addresses 0400h and 0420h.	<ul style="list-style-type: none"> - Check whether the transmitting timing of PDO from host controller is constant (not stop). - Increase the timeout value of the PDO watchdog detection. - Check whether there is any problem in wiring of the EtherCAT telecommunication cable. - Check whether the excessive noise has started the EtherCAT communication cable.
80	7	Synchronization signal error protection	More than the threshold value that the omission of the interruption processing by SYNC0 or IRQ set up by bit0-3 of Pr7.42 (Maximum continuation communication error) in after the completion of synchronous processing generated.	<p><In case of DC></p> <ul style="list-style-type: none"> - Check setting of DC mode. - Check whether propagation delay compensation or drift compensation is correct. <p><In case of SM2></p> <ul style="list-style-type: none"> - Check whether the transmitting timing of PDO from host controller is constant. - Check whether there is any problem in wiring of the EtherCAT communication cable. - Check whether the excessive noise has started the EtherCAT communication cable. - The preset value of Pr7.42 (Maximum continuation communication error) bit0-3 is enlarged. <p>- If the error cannot be resolved, shut off and reset the control power.</p>
85	2	Lost link error protection	The time set in Pr7.43 (Lost link detection time) elapsed when either Port 0 or Port 1 fell and remains in the lost link state after the ESM state transitioned from Init to PreOP (not including a port that had been in the lost link state at the time of transition from Init to PreOP).	<ul style="list-style-type: none"> - Check whether there is any problem in wiring of EtherCAT communication cable. - Check whether there is any problem in the communication from higher rank equipment.
87	1	Retracting operation completion (I/O)	This alarm occurs when a retracting operation by I/O is successfully completed.	<ul style="list-style-type: none"> - This is a security precaution, and there is no problem if it is an intended retracting operation. - It is an error that notifies the retracting operation execution.
87	2	Retracting operation completion (communication)	This alarm occurs when a retracting operation by communication is successfully completed.	<ul style="list-style-type: none"> - Make sure that return to origin is performed after the alarm is cleared.
87	3	Retracting operation error	Retracting operation activation failed due to one of the following conditions. Otherwise, the retracting operation was suspended. <ul style="list-style-type: none"> - The setting for Pr6.85 "Retracting operation condition setting" is abnormal - Retracting operations are enabled and the communication cycle is less than 0.250 ms - Drive inhibit input (POT/NOT) is detected during a retracting operation - A Retracting operation execution condition is satisfied although drive inhibit input (POT/NOT) has been detected - A retracting operation execution condition is satisfied during an operation not according to the communication command from the host device (such as test run) - The retracting operation was suspended in response to alarm detection during a retracting operation - Retracting operation activation failed due to a servo-off state and such 	<ul style="list-style-type: none"> - Confirm that there are no errors in parameter settings. - Confirm that there is no problem in the operating environment. - Make sure that return to origin is performed after the alarm is cleared.

(5) Retracting operation details

(5-1) Retracting operation activation conditions

A retracting operation is activated if either one of the conditions (1) and (2) is established.

Condition (1)

Pr6.85 bit 3-0 = 1 and Retracting operation input (RET) switches from off to on

Pr6.85 bit 3-0 = 2 and either the following conditions a or b is established

a. Near home input (HOME) is on and Retracting operation input (RET) switches from off to on

b. After Retracting operation input (RET) switches from off to on and

before Err87.1/Err87.2/Err87.3 occurs and Retracting operation input (RET) is turned off,

Near home input (HOME) switches from off to on

When Pr6.85 bit3-0 = 3 and main power supply off is detected,

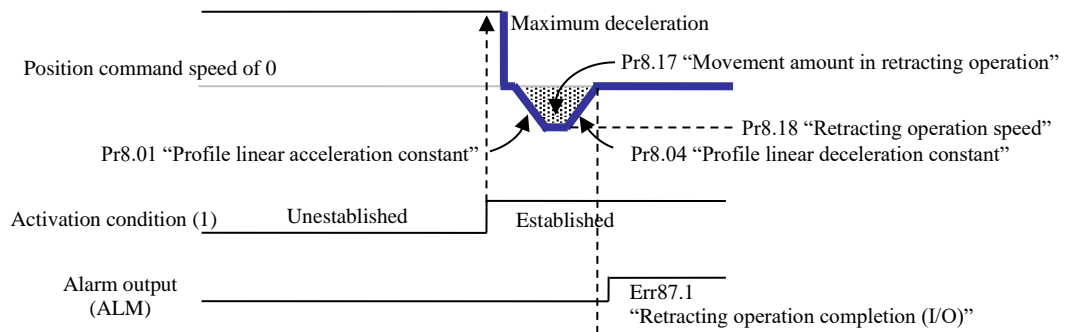

* Illustrated with pre-filter command waveforms

Condition (2)

Pr6.85 bit 7-4 = 1 and a communication error (Err80.4/Err80.7/Err85.2) is detected

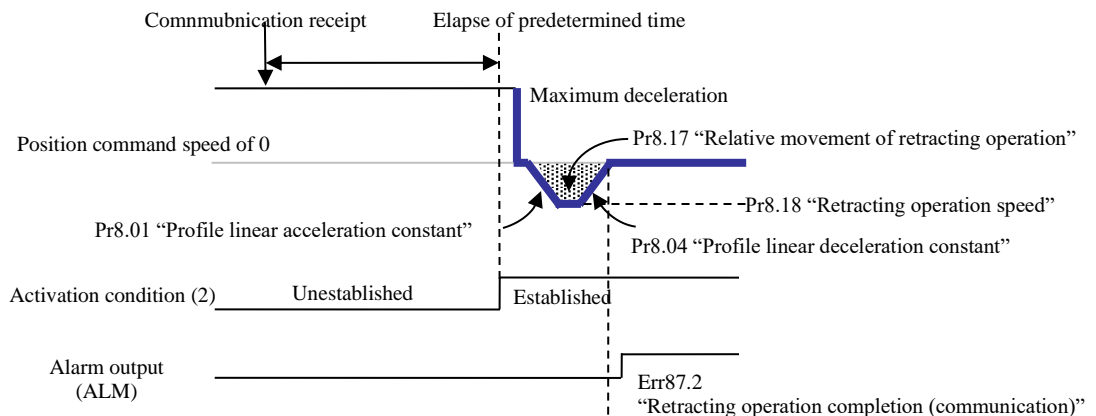

* Illustrated with pre-filter command waveforms

Err87.2
"Retracting operation completion (communication)"
* Err80.4/Err80.7/Err85.2 also occur, but front panel indication is Err87.2.

(5-2) About external break control at the time of retracting operation completion

If Err87.1 or Err87.2 occurs on retracting operation completion, the falling of the robot arm and others can be prevented by maintaining the energization to the motor until the external brake is actually operated after the brake release output (BRK-OFF).

For details, refer to "6-3-6 Fall prevention function in the event of alarms/Servo-ON".

(5-3) Retracting operation activation during motor operations

If the retracting operation activation condition (1) or (2) is established during motor drive, the motor stops at the maximum deceleration speed and evacuates.

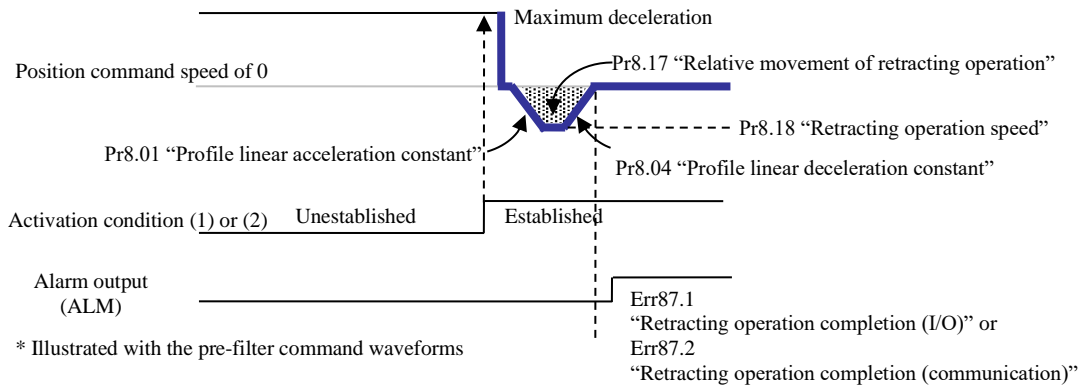

(5-4) Retracting operation activation during motor deceleration

If the retracting operation activation condition (1) or (2) is established under decelerated stop, the motor stops at the maximum deceleration speed and evacuates.

* Under decelerated stop means the state of being decelerated to stop based on the position command.

Under decelerated stop due to servo-off, main power off, or alarm generation, or under decelerated stop due to drive inhibit input, even if the retracting operation activation condition (1) or (2) is established, the motor does not evacuate, the position command stops, deceleration starts according to the deceleration sequence at the time of the alarm, and Err87.3 occurs.

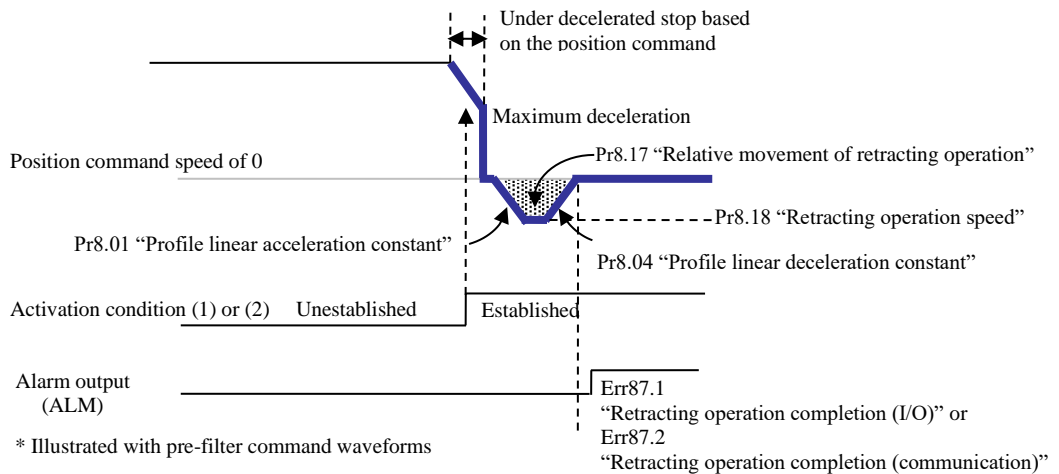

(5-5) Retracting operation in motor stop state

If the retracting activation condition (1) or (2) is established in stop state, the motor evacuates.

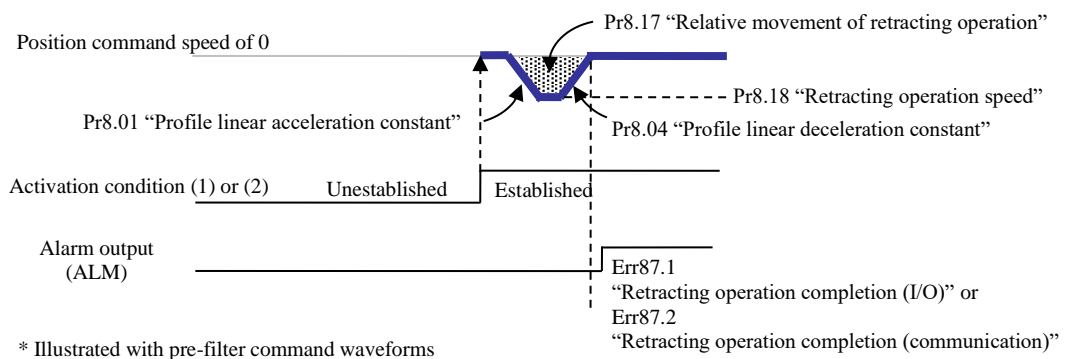

(5-6) Retracting operation activation cancellation conditions during motor drive

If one of the following activation cancellation conditions is established, regardless of the establishment of the retracting operation activation condition (1) or (2), the motor does not evacuate, the position command stops, deceleration starts according to the deceleration sequence at the time of the alarm, and Err87.3 occurs.

[Activation cancellation conditions]

- Drive inhibit input (POT, NOT) is ON
 - In operation independent of communication (such as test run)
 - Servo-Off
 - Under deceleration taking priority over retracting operations
- * For the priority order, refer to section 6-9-2 in the Technical Document, EtherCAT Communication Specifications (SX-DSV03307).

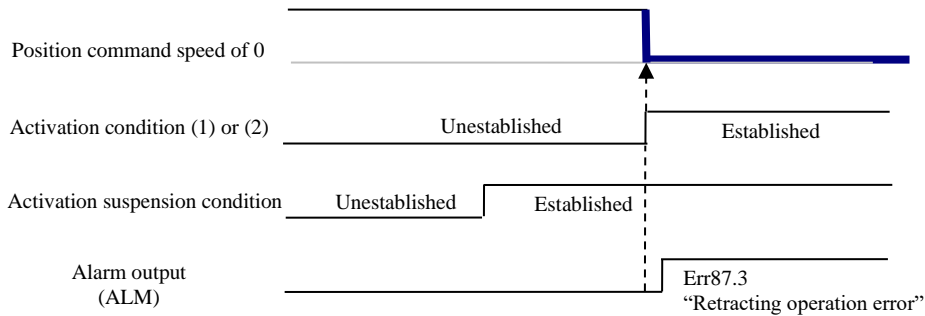

* Illustrated with pre-filter command waveforms

(5-7) Retracting operation suspension conditions

If one of the following execution suspension conditions is established during a retracting operation, the retracting operation is suspended, the position command stops, deceleration starts according to each deceleration sequence depending on the execution suspension condition, and Err87.3 occurs.

* If the retracting operation activation condition is unestablished during an activation operation, the current operation continues.

[Execution suspension conditions]

- Drive inhibit input (POT, NOT) is ON
 - Alarm generation
 - Main power off (when Pr6.85 bit3-0 is not 3)
 - STO input
- * Because the PDS is in a state of Fault reaction active during a retracting operation, servo-off by PDS state transition is unavailable. When using the retracting operation function, make sure that Force alarm input (E-STOP) is connected to have Err87.0 (Forced alarm input protection) generated by forced alarm input in an emergency and stop caused.
- * To prevent retracting operation suspension by main power off, it is recommended to set Pr5.09 (Main power off detection time) to 2000 (invalid). However, if voltage between P and N of the converter portion of the main power supply falls below the specified value, Err13.0 (Main power undervoltage protection (PN)) occurs and the retracting operation suspends.

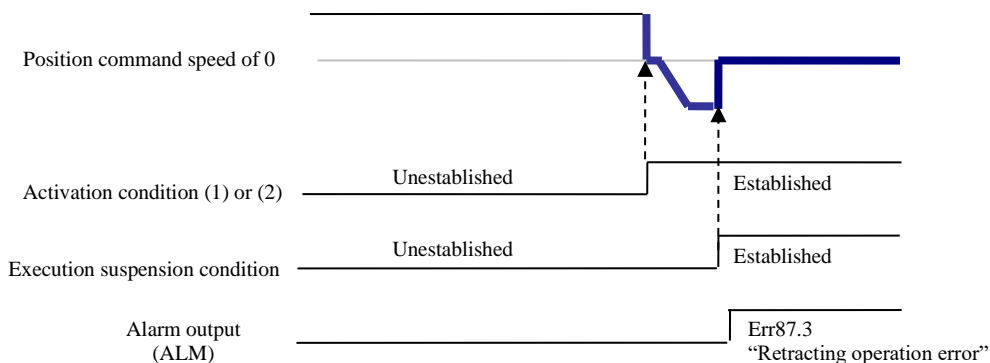

* Illustrated with pre-filter command

7. Protective function/Alarm function

7-1 List of protective function

This servo driver incorporates various protective functions. When a protective function is enabled, the servo driver turns OFF the alarm signal (ALM) and displays the error number on 7-segment LED of the panel section at front surface. *7

However, V frame is not equipped with a 7-segment LED.

Error No.		Alarm	Attribute			
Main	Sub		History	Can be cleared	Emergency stop *6	EtherCAT communication related
11	0	Control power supply undervoltage protection		○		
12	0	Over-voltage protection	○	○		
13	0	Main power supply undervoltage protection (between P to N)		○	○	
	1	Main power supply undervoltage protection (AC interception detection)		○	○	
14	0	Over-current protection	○			
	1	IPM error protection	○			
15	0	Over-heat protection	○		○	
16	0	Over-load protection	○	○*1		
	1	Torque saturation error protection	○	○		
18	0	Over-regeneration load protection	○		○	
	1	Regenerative transistor error protection	○			
24	0	Position deviation excess protection	○	○	○	
	1	Speed deviation excess protection	○	○	○	
26	0	Over-speed protection	○	○	○	
	1	2nd over-speed protection	○	○		
27	4	Position command error protection	○	○	○	
	6	Operation command contention protection	○	○		
	7	Position information initialization error protection	○	○*11		
28	0	Pulse regeneration limit protection	○	○	○	
29	1	Counter overflow protection 1	○			
	2	Counter overflow protection 2	○			
31	0	Safety function error protection 1	○			
	2	Safety function error protection 2	○			
33	0	Duplicated input allocation error 1 protection	○			
	1	Duplicated input allocation error 2 protection	○			
	2	Input function number error 1 protection	○			
	3	Input function number error 2 protection	○			
	4	Output function number error 1 protection	○			
	5	Output function number error 2 protection	○			
	8	Latch input allocation error protection	○			
34	0	Software limit protection	○	○		
36	0-1	EEPROM parameter error protection				
37	0-2	EEPROM check code error protection				
38	0	Over-travel inhibit input protection 1		○		
	1	Over-travel inhibit input protection 2		○		
	2	Over-travel inhibit input protection 3	○			
50	0	Feedback scale connection error protection	○			
	1	Feedback scale communication error protection	○			
	2	Feedback scale communication data error protection	○			

(To be continued)

Error No.		Alarm	Attribute			
Main	Sub		History	Can be cleared	Emergency stop *6	EtherCAT communication related
51	0	Feedback scale status error protection 0	○			
	1	Feedback scale status error protection 1	○			
	2	Feedback scale status error protection 2	○			
	3	Feedback scale status error protection 3	○			
	4	Feedback scale status error protection 4	○			
	5	Feedback scale status error protection 5	○			
55	0	A-phase connection error protection	○			
	1	B-phase connection error protection	○			
	2	Z-phase connection error protection	○			
	3	CS signal wiring error protection	○			
	4	AB phase open error protection	○			
60	0	Motor setting error protection				
	1	Motor combination error 1 protection				
	2	Motor combination error 2 protection				
	3	Linear motor automatic setting error protection	○	○		
61	0	Magnet pole position estimation error 1 protection	○	○		
	1	Magnet pole position estimation error 2 protection	○	○		
	2	Magnet pole position estimation error 3 protection				
70	0	U-phase current detector error protection	○			
	1	W-phase current detector error protection	○			
72	0	Thermal error protection	○			
80	0	ESM unauthorized request error protection	○	○	○	○
	1	ESM undefined request error protection	○	○	○	○
	2	Bootstrap requests error protection	○	○		○
	3	Incomplete PLL error protection	○	○		○
	4	PDO watchdog error protection	○	○	○	○
	6	PLL error protection	○	○	○	○
	7	Synchronization signal error protection	○	○	○	○
81	0	Synchronization cycle error protection	○	○		○
	1	Mailbox error protection	○	○		○
	4	PDO watchdog error protection	○	○		○
	5	DC error protection	○	○		○
	6	SM event mode error protection	○	○		○
	7	SyncManager2/3 error protection	○	○		○
	84	3	Synchronous establishment initialization error protection	○		
85	0	TxPDO assignment error protection	○	○		○
	1	RxPDO assignment error protection	○	○		○
	2	Lost link error protection	○	○	○	○
	3	SII EEPROM error protection	○			○
87	0	Forced alarm input protection		○	○	
	1	Retracting operation completion (I/O)*11	○	*8	○*9	
	3	Retracting operation error *11	○	*8	○	
88	0	Main power undervoltage protection (AC insulation detection 2)		○	○	○
	1	Control mode setting error protection	○	○	○	○
	2	ESM requirements during operation error protection	○	○	○	○
	3	Improper operation error protection	○		○	○

(To be continued)

Error No		Alarm	Attribute			
Main	Sub		History	Can be cleared	Emergency stop *6	EtherCAT communication related
92	1	Feedback scale data recovery error protection	○			
93	3	Feedback scale connection error protection	○			
	5	Parameter setting error protection 4	○			
	8	Parameter setting error protection 6	○			
94	3	Home position return error protection 2	○	○		
96	2	Control unit error protection 1	○			
	3	Control unit error protection 2	○			
	4	Control unit error protection 3	○			
	5	Control unit error protection 4	○			
	6	Control unit error protection 5	○			
	7	Control unit error protection 6	○			
	8	Control unit error protection 7	○			
	98	2	Communication hardware error protection 2	○		
3		Communication hardware error protection 3	○			
5		Hardware self-diagnosis abnormality protection 1				
Other		Other error protection	—	—	—	—

- *1: When Err 16.0 (Over-load protection) is triggered, you can clear it in 10 sec or longer after the error occurs. Recognized as alarm clear command and used for clearing process as the condition becomes ready for process.
- *2: When Err 40.0 (Absolute system down error protection) or Err 42.0 (Absolute over-speed error protection) occurs, the alarm cannot be cleared until the absolute encoder is reset.
- *3: If the alarm cannot be cleared occurs, remove the alarm cause, turn OFF power to reset.
- *4: When clearable alarm other than EtherCAT communication-related error (Err80.*, Err81.*, Err85.*, Err88.*) is occurred, it will be able to clear the alarm in the following way.
- When an alarm clear input (A-CLR) is OFF, or while not assigning, the alarm clearance was performed from EtherCAT communication or USB communication(PANATERM).
 - The alarm clear input (A-CLR) was changed from OFF to ON.

In the following cases, keep in mind that an alarm clearance is not carried out normally.

Example: The alarm clearance is performed from communication (USB or EtherCAT) when A-CLR is ON.

In this case, perform an alarm clearance from communication after turning OFF A-CLR.

Please perform the alarm clearance while motor is stopped after ensuring safety.

Please refer to section 8-4 "Clear error (alarm)/Clear warning" of Technical Document "EtherCAT Communication Specifications" (SX-DSV03307) for details of the alarm clear method of than EtherCAT communication-related error (Err80.*, Err81.*, Err85.*, Err88.*).

- *5: If the servo driver internal control circuit malfunctions due to excessive noise etc., the display will show as follows:



Immediately turn OFF power.

- *6: Emergency stop is triggered if Pr 5.10 Sequence at alarm is set to one of 4 to 7 and corresponding alarm is detected. For details, refer to 6-3-4 Sequence at alarm.
- *7: About EtherCAT communication-related error (Err80.*, Err81.*, Err85.*, Err88.*), front panel indication or alarm indication of PANATERM is delayed from actual occurrence of alarm.

- *8: Depending on the Pr6.86 bit 0 to 2 settings, the properties of error clear vary.
bit 0: Err87.1 (Retracting operation completion (I/O)) alarm clear attribute
bit 1: Err87.2 (Retracting operation completion (communication)) alarm clear attribute
bit 2: Err87.3 (Retracting operation error) alarm clear attribute
0: Unable to clear alarms and 1: Able to clear alarms for all
- *9: It is an emergency stop alarm according to the attribute, but when the retracting operation activation condition is established, the operation does not conform to Pr5.10 "Sequence at alarm" but it is determined by the retracting operation function, and an alarm is generated after retracting operation completion.
For details of the retracting operation function, refer to section 6-9.
It behaves as the emergency stop alarm, for example, in a manner that the fall prevention function in alarms works after retracting operation completion.
For the fall prevention function in alarms, refer to section 6-3-6-1.
- *10 : The deceleration method when an EtherCAT related alarm (Err80.*, Err81.*, Err85.*, Err88.*) occurs is in accordance with 605Eh (Fault reaction active).
Change the setting from the shipment value according to the equipment environment.
- *11 : In the function expansion version 9 of the software version (Ver1.14) and later, alarm clearance is available.

7-2 Details of Protective function

Error No.		Protective function	Causes	Measures
Main	Sub			
11	0	Control power supply undervoltage protection	<p>Voltage between P and N of the converter portion of the control power supply has fallen below the specified value.</p> <ol style="list-style-type: none"> 1) Power supply voltage is low. Instantaneous power failure has occurred 2) Lack of power capacity...Power supply voltage has fallen down due to inrush current at the main power-on. 3) Failure of servo driver (failure of the circuit) 	<p>Measure the voltage between lines of connector and terminal block (L1C-L2C).</p> <ol style="list-style-type: none"> 1) Increase the power capacity. Change the power supply. 2) Increase the power capacity. 3) Replace the driver with a new one. <p>※For V frame, the voltage between lines P2 and N2 is measured.</p>
12	0	Over-voltage protection	<p>Power supply voltage has exceeded the permissible input voltage. = Voltage between P and N of the converter portion of the control power supply has exceeded the specified value. Source voltage is high. Voltage surge due to the phase-advancing capacitor or UPS (Uninterruptible Power Supply) have occurred.</p> <ol style="list-style-type: none"> 1) Disconnection of the regeneration discharge resistor 2) External regeneration discharge resistor is not appropriate and could not absorb the regeneration energy. 3) Failure of servo driver (failure of the circuit) 	<p>Measure the voltage between lines of connector (L1, L2 and L3). Enter correct voltage. Remove a phase advancing capacitor.</p> <ol style="list-style-type: none"> 1) Measure the resistance of the external resistor connected between terminal P and B of the driver. Replace the external resistor if the value is ∞. 2) Change to the one with specified resistance and wattage. 3) Replace the driver with a new one. <p>※For V frame, the voltage between lines P1 and N1 is measured.</p>
13	0	Main power supply undervoltage protection (PN)	<p>Instantaneous power failure has occurred between L1 and L3 for longer period than the preset time with Pr 5.09 (Main power off detecting time) while bit0 of Pr 5.08 (LV trip selection at the main power-off) is set to 1. Or the voltage between P and N of the converter portion of the main power supply has fallen below the specified value during Servo-ON. * When executing an escape operation with the trigger of main power off, Err13.1 does not occur.</p> <ol style="list-style-type: none"> 1) Power supply voltage is low. Instantaneous power failure has occurred 2) Instantaneous power failure has occurred. 3) Lack of power capacity...Power supply voltage has fallen down due to inrush current at the main power-on. 4) Phase lack...3-phase input driver has been operated with single phase input. 5) Failure of servo driver (failure of the circuit) 	<p>Measure the voltage between lines of connector (L1, L2 and L3).</p> <ol style="list-style-type: none"> 1) Increase the power capacity. Change the power supply. Remove the causes of the shutdown of the magnetic contactor or the main power supply, then re-enter the power. 2) Set up the longer time to Pr 5.09 (Main power off detecting time). Set up each phase of the power correctly. 3) Increase the power capacity. For the capacity, refer to Standard specification "Driver and List of Applicable Peripheral Equipments" of Preparation. 4) Connect each phase of the power supply (L1, L2 and L3) correctly. For single phase, 100 V and 200 V driver, use L1 and L3. 5) Replace the driver with a new one. <p>※For V frame, the voltage between lines P1 and N1 is measured.</p>
	1	Main power supply undervoltage protection (AC)		
14	0	Over-current protection	<p>Current through the converter portion has exceeded the specified value.</p> <ol style="list-style-type: none"> 1) Failure of servo driver (failure of the circuit, IGBT or other components) 2) Short of the motor wire (U, V and W) 3) Earth fault of the motor wire 4) Burnout of the motor 5) Poor contact of the motor wire. 	<ol style="list-style-type: none"> 1) Turn to Servo-ON, while disconnecting the motor. If error occurs immediately, replace with a new driver. 2) Check that the motor wire (U, V and W) is not shorted, and check the branched out wire out of the connector. Make a correct wiring connection. 3) Measure the insulation resistance between motor wires, U, V and W and earth wire. In case of poor insulation, replace the motor. 4) Check the balance of resistor between each motor line, and if unbalance is found, replace the motor. 5) Check the loose connectors. If they are, or pulled out, fix them securely. 6) Replace the servo driver. Do not use servo ON/OFF during operation. 7) Enter the commands 100 ms or longer after Servo-ON. 8) Replace the driver.
	1	IPM error protection (IPM: Intelligent Power Module)		

(To be continued)

Error No.		Protective function	Causes	Measures
Main	Sub			
15	0	Over-heat protection	<p>Temperature of the heat sink or power device has been risen over the specified temperature.</p> <ol style="list-style-type: none"> 1) Ambient temperature has risen over the specified temperature. 2) Over-load 	<p>Check the operating temperature range of the servo driver.</p> <ol style="list-style-type: none"> 1) Improve the ambient temperature and cooling condition. 2) Increase the capacity of the driver and motor. Set up longer acceleration/ deceleration time. Lower the load.
16	0	Over-load protection	<p>Torque command value has exceeded the over-load level set with Pr 5.12 (Setup of over-load level) and resulted in overload protection according to the time characteristics (described later).</p> <ol style="list-style-type: none"> 1) Load was heavy and actual torque has exceeded the rated torque and kept running for a long time. 2) Oscillation and hunching action due to poor adjustment of gain. Motor vibration, abnormal noise. Inertia ratio (Pr 0.04) setup error. 3) Miswiring, disconnection of the motor. 4) Machine has collided or the load has gotten heavy. Machine has been distorted. 5) Electromagnetic brake has been kept engaged. 6) While wiring multiple axes, miswiring has occurred by connecting the motor cable to other axis. 7) Pr5.12 "Over-load level setup" is too low. <p>■ The over-load protection time characteristics are described on the end of this section.</p>	<p>Check that the torque (current) does not oscillates nor fluctuate up and down very much on the graphic screen of the network. Check the over-load alarm display and load factor with the network.</p> <ol style="list-style-type: none"> 1) Increase the capacity of the servo driver and motor. Set up longer acceleration/ deceleration time. Lower the load. 2) Make a re-adjustment of gain. 3) Make a wiring as per the wiring diagram. Replace the cables. 4) Remove the cause of distortion. Lower the load. 5) Measure the voltage between brake terminals. Release the brake 6) Wire the motor and feedback scale lines correctly so that they agree with the axis. 7) Set Pr5.12 "Over-load level setup" to 0 (Set the maximum value allowed for the motor).
	1	Torque saturation error protection	<p>Torque saturated has continued for the period set to Pr 7.16 "Torque saturation error protection frequency" or Pr6.57 "Torque saturation error protection detection time".</p>	<ul style="list-style-type: none"> • Check the operating state of the driver. • Take the same measure as done against Err16.0.
18	0	Over-regeneration load protection	<p>Regenerative energy has exceeded the capacity of regenerative resistor.</p> <ol style="list-style-type: none"> 1) Due to the regenerative energy during deceleration caused by a large load inertia, converter voltage has risen, and the voltage is risen further due to the lack of capacity of absorbing this energy of the regeneration discharge resistor. 2) Regenerative energy has not been absorbed in the specified time due to a high motor rotational speed. 3) Active limit of the external regenerative resistor has been limited to 10% duty. <p>Caution: Install an external protection such as thermal fuse without fail when you set up Pr 0.16 to 2. Otherwise, regenerative resistor loses the protection and it may be heated up extremely and may burn out.</p>	<p>Check the load factor of the regenerative resistor from the front panel or via communication. Do not use in the continuous regenerative brake application.</p> <ol style="list-style-type: none"> 1) Check the running pattern (speed monitor). Check the load factor of the regenerative resistor and over-regeneration warning display. Increase the capacity of the driver and the motor, and loosen the deceleration time. Use the external regenerative resistor. 2) Check the running pattern (speed monitor). Check the load factor of the regenerative resistor. Increase the capacity of the driver and the motor, and loosen the deceleration time. Lower the motor rotational speed. Use an external regenerative resistor. 3) Set up Pr 0.16 to 2.
	1	Regenerative transistor error protection	<p>Regenerative driver transistor on the servo driver is defective.</p>	<p>Replace the driver.</p>

(To be continued)

Error No.		Protective function	Causes	Measures
Main	Sub			
24	0	Position deviation excess protection	<p>Deviation pulses have exceeded the setup of Pr 0.14.</p> <p>1) The motor movement has not followed the command.</p> <p>2) Setup value of Pr 0.14 (Position deviation excess setup) is small.</p>	<p>1) Check that the motor follows to the position command pulses. Check that the output torque has not saturated in torque monitor. Make a gain adjustment. Set up maximum value to Pr 0.13 and Pr 5.22. Make a feedback scale wiring as per the wiring diagram. Set up the longer acceleration/deceleration time. Lower the load and speed.</p> <p>2) Set up a larger value to Pr 0.14.</p>
	1	Speed deviation excess protection	<p>The difference between the internal positional command speed and actual speed (speed deviation) exceeds the setup value of Pr 6.02(Speed deviation excess setup). Note: If the internal positional command speed is forcibly set to 0 due to instantaneous stop caused by the positive/negative over-travel inhibit input, the speed deviation rapidly increases at this moment. Pr 6.02 setup value should have sufficient margin because the speed deviation also largely increases on the rising edge of the internal positional command speed.</p>	<ul style="list-style-type: none"> • Increase the setup value of Pr 6.02. • Lengthen the acceleration/deceleration time of internal positional command speed, or improve the follow-up characteristic by adjusting the gain. • Disable the excess speed deviation detection (Pr 6.02 = 0).
26	0	Over-speed protection	The motor rotational speed has exceeded the setup value of Pr 5.13.	<ul style="list-style-type: none"> • Do not give an excessive speed command. • Check the command pulse input frequency and division/multiplication ratio. • Make a gain adjustment when an overshoot has occurred due to a poor gain adjustment. • Make a wiring connection of the feedback scale as per the wiring diagram.
	1	2nd over-speed protection	The motor rotational speed has exceeded the setup value of Pr 6.15.	

(To be continued)

Error No.		Protective function	Causes	Measures
Main	Sub			
27	4	Position command error protection	Position command variation (value after electronic gear) exceeds the specified value.	<ul style="list-style-type: none"> • Check whether the variation is not large, such as the position command operation by the cyclic synchronous position control (csp). • Check electronic gear ratio. • Execute return to origin again after clearing the alarm when Err27.4 occurs under incremental mode, as return to origin will be incomplete.
	6	Operation command contention protection	<ul style="list-style-type: none"> • When Pr7.99 bit0=0 is set, EtherCAT communications established during test run or FFT operating. • When Pr7.99 bit0=1 is set, servo ON command by EtherCAT communications received during test run or FFT operating. 	<ul style="list-style-type: none"> • Check that EtherCAT has not been established during test run or FFT when Pr7.99 bit0=0 is set. • Check that servo ON command by EtherCAT communication has not been sent from the host controller during test run or FFT when Pr7.99 bit0=1 is set.
	7	Position information initialization error protection	• In the hm mode, return to origin has been canceled by halt from the host device between origin detection and return to origin completion.27.7	• Check if homing command is canceled near the home position signal.
28	0	Pulse regeneration limit protection	The output frequency of pulse regeneration has exceeded the limit.	<ul style="list-style-type: none"> • Check the setup value of Pr0.11 (Numerator of pulse output division) and Pr5.03 (Denominator of pulse output division). • To disable the detection, set Pr5.33 (Pulse regenerative output limit setup) to 0.
29	1	Counter overflow protection 1	The calculation value (the absolute encoder (or the absolute external scale) position information [pulse] / electronic gear ratio) has exceeded 32bit width or an overflow occurred during the calculation, when the control power is ON in absolute mode, EtherCAT communication is established (Init -> PreOp), returning to origin is completed, the absolute multi-turn data is cleared, PANATERM operation (test run, frequency characteristic analysis, Z phase search, fit gain) is completed, or pin assign is executed by PANATERM.	• Check the operation range at the position of absolute feedback scale and electronic gear ratio.
	2	Counter overflow protection 2	Position deviation (pulse unit) became $\pm (2^{30} - 1)$ (1073741823) or more. Or the position deviation (command unit) exceeds $\pm 2^{30}$ (1073741824).	<ul style="list-style-type: none"> • Check that the motor runs as per the position command pulses. • Check that the output torque has not saturated in torque monitor. • Make a gain adjustment. • Set up maximum value to torque limit setting. • Make a wiring connection of the feedback scale as per the wiring diagram.
31	0	Safety function error protection 1	Safety function has detected an error.	<ul style="list-style-type: none"> • In case of the repeated occurrence, because failure is possible, replace the servo driver. Return to a dealer for investigation (repair).
	2	Safety function error protection 2		

(To be continued)

Error No.		Protective function	Causes	Measures
Main	Sub			
33	0	Duplicated input allocation error 1 protection	Input signals (SI1, SI2, SI3, SI4) are assigned with two functions.	Allocate correct function to each connector pin.
	1	Duplicated input allocation error 2 protection	Input signals (SI5, SI6, SI7, SI8) are assigned with two functions.	Allocate correct function to each connector pin.
	2	Input function number error 1 protection	Input signals (SI1, SI2, SI3, SI4) are assigned with undefined number. Or, logical setup is not correct.	Allocate correct function to each connector pin.
	3	Input function number error 2 protection	Input signals (SI5, SI6, SI7, SI8) are assigned with undefined number. Or, logical setup is not correct.	Allocate correct function to each connector pin.
	4	Output function number error 1 protection	Output signals (SO1) are assigned with undefined number.	Allocate correct function to each connector pin.
	5	Output function number error 2 protection	Output signals (SO2, SO3) are assigned with undefined number.	Allocate correct function to each connector pin.
	8	Latch input allocation error protection	Error has occurred during function assignment of latch correction pins (SI5, SI6, and SI7). <ul style="list-style-type: none"> • EXT1 must be allocated to SI5 and EXT2 to SI6: but these are assigned to other pins. • HOME is allocated to SI6 or SI7; POT is allocated to SI5 or SI7; NOT is allocated to SI5 or SI6. • Function not allocated to all control modes. 	Allocate correct function to each connector pin.
34	0	Software limit protection	When a position command within the specified input range is given, the motor operates outside its working range specified in Pr 5.14 (Motor working range setup). 1) Gain is not appropriate. 2) Pr 5.14 setup value is low.	1) Check the gain (balance between position loop gain and velocity loop gain) and inertia ratio. 2) Increase the setup value of Pr 5.14. Or, Set Pr 5.14 to 0 to disable the protective function.
36	0	EEPROM parameter error protection	Data in parameter storage area has been damaged when reading the data from EEPROM at power-on.	<ul style="list-style-type: none"> • Set up all parameters again. • If the error persists, replace the driver (it may be a failure.) • Return the product to the dealer or manufacturer.
	1			
37	0	EEPROM check code error protection	Data for writing confirmation to EEPROM has been damaged when reading the data from EEPROM at power-on.	<ul style="list-style-type: none"> • Replace the driver. (it may be a failure). • Return the product to the dealer or manufacturer.
	1			
	2			
38	0	Over-travel inhibit input protection 1	<ul style="list-style-type: none"> • With Pr 5.04, over-travel inhibit input setup = 0, both positive and negative over-travel inhibit inputs (POT/NOT) have been ON. • With Pr 5.04 = 2, positive or negative over-travel inhibit input has turned ON. • With Pr 5.04 = 0 or 1, and either of the positive and negative over-travel inhibit input has turned ON during the execution of magnet pole position estimation. • Positive or negative over-travel inhibit input has turned ON while Pr5.04 = 0 or 1 and linear motor automatic setup is being executed. 	Check that there are not any errors in switches, wires or power supply which are connected to positive direction/ negative direction over-travel inhibit input. Check that the rising time of the control power supply (12 to 24 VDC) is not slow.
	1	Over-travel inhibit input protection 2	An operation command (e.g. test run, FFT) has been received through USB communication (PANATERM) while EtherCAT communication is OFF with Pr 5.04 "over-travel inhibition input setting" = 0 or 1, and either POT or NOT is ON. Or, POT or NOT is turned ON while the system is operating according to the command given through USB communication.	Check that there are not any errors in switches, wires or power supply which are connected to positive direction/ negative direction over-travel inhibit input. Check that the rising time of the control power supply (12 to 24 VDC) is not slow.
	2	Over-travel inhibit input protection 3	With POT allocated to SI6 or NOT to SI7, Pr 5.04 "Over-travel inhibit input setup" is set to a value other than 1 (CoE side deceleration stop).	<ul style="list-style-type: none"> • When POT is allocated to SI6 or NOT allocated to SI7, make sure that Pr 5.04 "Over-travel inhibit input setup" is set to 1 (CoE side deceleration stop).

(To be continued)

Error No.		Protective function	Causes	Measures
Main	Sub			
50	0	Feedback scale connection error protection	Communication between the feedback scale and the driver has been interrupted in certain times, and disconnection detecting function has been triggered.	<ul style="list-style-type: none"> Make a wiring connection of the feedback scale as per the wiring diagram. Correct the miswiring of the connector pins.
	1	Feedback scale communication error protection	Communication error has occurred in data from the feedback scale. Mainly data error due to noise. Feedback scale cables are connected, but communication data has some error.	<ul style="list-style-type: none"> Secure the power supply for the feedback scale of 5 VDC $\pm 5\%$ (4.75 to 5.25 V)...pay attention especially when the feedback scale cables are long. Separate the feedback scale cable and the motor cable if they are bound together. Connect the shield to FG...refer to wiring diagram of feedback scale in Standard specification.
	2	Feedback scale communication data error protection	The data from the feedback scale was not a communication error, but the contents of the data became an error. Data error mainly caused by noise. Feedback scale connecting cable was connected, but communication data became an error.	
51	0	Feedback scale status error protection 0	Bit 0 of the feedback scale error code (ALMC) has been turned to 1. Check the specifications of the feedback scale.	<p>After removing the cause of the error, clear the feedback scale error.</p> <p>And then, shut off the power to reset.</p>
	1	Feedback scale status error protection 1	Bit 1 of the feedback scale error code (ALMC) has been turned to 1. Check the specifications of the feedback scale.	
	2	Feedback scale status error protection 2	Bit 2 of the feedback scale error code (ALMC) has been turned to 1. Check the specifications of the feedback scale.	
	3	Feedback scale status error protection 3	Bit 3 of the feedback scale error code (ALMC) has been turned to 1. Check the specifications of the feedback scale.	
	4	Feedback scale status error protection 4	Bit 4 of the feedback scale error code (ALMC) has been turned to 1. Check the specifications of the feedback scale.	
	5	Feedback scale status error protection 5	Bit 5 of the feedback scale error code (ALMC) has been turned to 1. Check the specifications of the feedback scale.	
55	0	A-phase connection error protection	A-phase connection in the feedback scale is defective, e.g. discontinued.	Check the A-phase connection of feedback scale.
	1	B-phase connection error protection	B-phase connection in the feedback scale is defective, e.g. discontinued.	Check the B-phase connection of feedback scale.
	2	Z-phase connection error protection	Z-phase connection in the feedback scale is defective, e.g. discontinued.	Check the Z-phase connection of feedback scale.
	3	CS signal logic error protection	There is an error in CS signal logic. (All of CS signals 1, 2, and 3 are high or low)	Check the CS signal wiring connections.
	4	AB-phase missing error protection	There are extremely few AB-phase pulses between CS signal changes.	Check the CS signal, A phase, and B phase wiring connections.

(To be continued)

Error No.		Protective function	Causes	
Main	Sub			
60	0	Motor setting error protection	<ul style="list-style-type: none"> • Pr9.00 “Motor type selection” = 0 has been set. • A setup value out of the range has been set as a setup value for Pr 9.01 “Feedback scale resolution/number of scale pulse per rotation”. • When setting Pr 9.00 = 1(Linear type), Pr 9.02 “Magnet pole pitch” and Pr 9.30 “Number of pulses per magnet pole” has been set at the same time. • When setting Pr 9.00 = 1 “Linear type”, a value out of the range has been set as a setup value for Pr 9.30 “Number of pulses per magnet pole”. • When setting Pr 9.00 = 2 (Rotary type), Pr 9.03 “Pole logarithm per rotation” = 0 has been set. • When setting Pr 9.08 “Motor phase inductance” = 0, Pr 9.12 “Automatic current response adjustment” $\neq 0$ has been set. • When setting Pr 9.09 “Motor phase resistance”, Pr 9.12 $\neq 0$ has been set. • Number 0 has been set to each of Pr 9.04 to Pr 9.07, Pr 9.10, and Pr 9.20. • Pr9.00=1 (linear) or 3 (linear (VCM)) In the setting process, Pr3.23 “Feedback scale type select”=6 was set up. 	<ul style="list-style-type: none"> • Check the setup value for Pr9.00 “Motor type selection.” • Check the setup value for Pr9.01 “Feedback scale resolution/number of scale pulse per rotation.” • Check the setup value for each of Pr 9.00 “Motor type selection”, Pr 9.02 “Magnet pole pitch”, and Pr 9.30 “Number of pulses per magnet pole”. • Check the setup value for each of Pr 9.00 “Motor type selection“ and Pr 9.30 “Number of pulses per magnet pole”. • Check the setup value for each of Pr 9.00 “Motor type selection“ and Pr .9.03 “Pole logarithm per rotation”. • Check the setup value for each of Pr 9.08 “Motor phase inductance” and Pr 9.12 “Automatic current response adjustment”. • Check the setup value for each of Pr 9.09 “Motor phase resistance” and Pr 9.12 “Automatic current response adjustment”. • Check the setup value for each of Pr 9.04 to Pr 9.07, Pr 9.10, and Pr 9.20. • Check the setup value for each of Pr 9.00 “Motor type selection“ and Pr 3.23 “Feedback scale type selection”. Under linear type setting, an absolute rotary scale can't be used.
	1	Motor combination error 1 protection	<ul style="list-style-type: none"> • The setup value for Pr 9.06 “Rated effective motor current” is above the allowable rated current for the driver. • The setup value for Pr 9.07 “Maximum instantaneous motor current” is above the allowable maximum current for the driver. • When setting Pr 9.00 = 2 (Rotary type), feedback speed that correspond with overspeed level [r/min] exceed 1091M [pulse/s]. 	<ul style="list-style-type: none"> • Check the setup value for Pr 9.06 “Rated effective motor current” (Setting unit: 0.1 Arms). • Check the setup value for Pr 9.07 “Maximum instantaneous motor current” (Setting unit: 0.1 A). • If the above setup value is not problematic, the frame size of the driver needs to be enlarged. • Check the setup value for each of Pr 9.01 “Number of scale pulse per rotation” and Pr 9.10 “Overspeed level” in order f or feedback speed not to exceed 1091M [pulse/s].
	2	Motor combination error 2 protection	<ul style="list-style-type: none"> • The rated motor current is too small as against the rated driver current. • A ratio of an inertia (J) to the rated torque (T) is too large. (The J-T ratio is too large) • The automatically adjusted current proportional integral gain is too large. • The percentage of the maximum current to the rated motor current is larger than 500% 	<ul style="list-style-type: none"> • Check the setup value for Pr 9.06 “Rated effective motor current” (Setting unit: 0.1 Arms). If the above setup value is not problematic, the frame size of the driver needs to be reduced. • Check the setup value for each of Pr 9.05 “Rated motor torque” (Setting unit: 0.1 Nm) and Pr 9.04 “Motor inertia” (Setting unit: 0.00001 kgm²). • Check the setup value for each of Pr 9.06 “Rated effective motor current”(Setting unit: 0.1 Arms), Pr 9.08 “Motor phase inductance” (Setting unit: 0.01 mH), and Pr 9.09 “Motor phase resistance”(Setting unit: 0.01 Ω) • Check the setup value for each of Pr 9.07 “Maximum instantaneous motor current” (Setting unit: 0.1 A) and Pr 9.06 “Rated effective motor current” (Setting unit: 0.1 Arms).
	3	Linear motor automatic setting error protection	<ul style="list-style-type: none"> • EtherCAT communication has been established during automatic linear motor setup (during automatic scale direction/CS setting and during automatic current gain adjustment) • After automatic linear motor setting, EtherCAT communication has been established with the power supply not turned ON again A feedback current value has been overshoot respective to the thrust command during automatic linear motor setting. 	<ul style="list-style-type: none"> • Make sure that no EtherCAT communication will be established during automatic linear motor setting (during automatic scale direction/CS setting and during automatic current gain adjustment) • After automatic linear motor setting, establish communication with the host device after the power supply is turned ON. • If there is current overshooting present, make adjustments such as by reducing the current gain.

(To be continued)

Error No.		Protective function	Causes	
Main	Sub			
61	0	Magnet pole position estimation error 1 protection	Magnet pole position estimation has not been finished correctly. <ul style="list-style-type: none"> • Wrong feedback scale direction setting • Shortage of thrust command/command time at the time of magnet pole position estimation • Use of the vertical axis • An unbalanced load and a large friction 	<ul style="list-style-type: none"> • Check the direction of the feedback scale • Adjust Pr .9.22 “Thrust command time for magnet pole position estimation” and Pr 9.23 “Command thrust for magnet pole position estimation”. • The magnet pole position estimation function cannot be used for the vertical axis and an axis with an unbalanced load and a large friction.
	1	Magnet pole position estimation error 2 protection	The motor has not stopped after the elapse of the time set using Pr 9.27 “Motor stop control time for magnet pole position estimation”.	<ul style="list-style-type: none"> • Increase the setup value for Pr 9.27 • Check for unbalanced loads in the setup environment. (Does the motor operate even when with thrust command = 0?)
	2	Magnet pole position estimation error 3 protection	<ul style="list-style-type: none"> • A value of 3 has been set to Pr 9.20 (Magnet pole detection scheme selection) with magnet pole position estimation never executed. • A value of 3 has been set to Pr 9.20 when a feedback scale that is not of the absolute type is in use. 	<ul style="list-style-type: none"> • Temporarily use Pr 9.20 = 2 and perform magnet pole position estimation once. Then use Pr 9.20 = 3, and this error will not be activated. • Check that the feedback scale is of the absolute type.
70	0	U-phase current detector error protection	U-phase current detection offset value has some error.	<ul style="list-style-type: none"> • Turn off power once, and turn on again. • Even so, if an error indication appears and an error occurs, failure is possible. Discontinue the use and replace the motor and servo driver. • Check the parameter settings again. Return to a dealer for investigation (repair).
	1	W-phase current detector error protection	W-phase current detection offset value has some error.	
72	0	Thermal error protection	Thermal has some error.	

(To be continued)

Error No.		Protective function	Causes	Measures
Main	Sub			
80	0	ESM unauthorized request error protection	The change state request which cannot change from the present state was received. Init to SafeOP Init to OP PreOP to OP OP to Bootstrap PreOP to Bootstrap SafeOP to Bootstrap	Check the change state request of host controller.
	1	ESM undefined request error protection	The change state request which does not have a definition (except the following) was received. 1 : Request Init State 2 : Request Pre-Operational State 3 : Request Bootstrap State 4 : Request Safe-Operational State 8 : Request Operational State	Check the change state request of host controller.
	2	Bootstrap requests error protection	The following change state request was received. 3 : Request Bootstrap State	Check the change state request of host controller.
	3	Incomplete PLL error protection	Phasing servo and communication (PLL lock) could not be completed even after the lapse of 1s after the start of the synchronization process. When Pr7.110 bit8 is 1, more than the threshold value that the omission of the interruption processing by SYNC0 or IRQ set up by bit0-3 of Pr7.42 (Maximum continuation communication error) in after the completion of synchronous processing generated.	<In case of DC> - Check setting of DC mode. - It is checked whether propagation delay compensation or drift compensation is correct. <In case of SM2> - It is checked whether the transmitting timing of PDO from host controller is constant. - Please check whether there is any problem in wiring of the EtherCAT communication cable. - Please check whether the excessive noise has started the EtherCAT communication cable. - The preset value of Pr7.42 (Maximum continuation communication error) bit0-3 is enlarged. - If the error cannot be resolved, shut off and reset the control power.
	4	PDO watchdog error protection	During PDO communication (SafeOP or OP state), bit10 of AL Event Request(0220h) did not turn on within the time is set ESC register addresses 0400h and 0420h.	- Check whether the transmitting timing of PDO from host controller is constant (not stop). - Increase the timeout value of the PDO watchdog detection. - Check whether there is any problem in wiring of the EtherCAT telecommunication cable. - Check whether the excessive noise has started the EtherCAT communication cable.
	6	PLL error protection	In the ESM state is SafeOP or OP, phasing servo and communication (PLL lock) was separated.	<In case of DC> - Check setting of DC mode. - Check whether propagation delay compensation or drift compensation is correct. <In case of SM2> - Check whether the transmitting timing of PDO from host controller is constant. - Check whether there is any problem in wiring of the EtherCAT communication cable. - Check whether the excessive noise has started the EtherCAT communication cable. - If the error cannot be resolved, shut off and reset the control power.

(To be continued)

Error No.		Protective function	Causes	Measures
Main	Sub			
80	7	Synchronization signal error protection	More than the threshold value that the omission of the interruption processing by SYNC0 or IRQ set up by bit0-3 of Pr7.42 (Maximum continuation communication error) in after the completion of synchronous processing generated.	<p><In case of DC></p> <ul style="list-style-type: none"> - Check setting of DC mode. - Check whether propagation delay compensation or drift compensation is correct. <p><In case of SM2></p> <ul style="list-style-type: none"> - Check whether the transmitting timing of PDO from host controller is constant. - Check whether there is any problem in wiring of the EtherCAT communication cable. - Check whether the excessive noise has started the EtherCAT communication cable. - The preset value of Pr7.42 (Maximum continuation communication error) bit0-3 is enlarged. <p>- If the error cannot be resolved, shut off and reset the control power.</p>
81	0	Synchronization cycle error protection	<p>It is set to an unsupported synchronization cycle (SYNC0 cycle or an IRQ cycle).</p> <ul style="list-style-type: none"> - It sets except 125000, 250000, 500000, 1000000, 2000000, and 4000000 [ns] to ESC register SYNC0 Cycle Time (09A0h) and object 1C32h-02h (Cycle time). - The setting of ESC register and object is not in agreement. 	- Please set up a synchronous period correctly.
	1	Mailbox error protection	<p>Mailbox SyncManager 0/1 setting is wrong.</p> <ul style="list-style-type: none"> - A Physical Start Address:ESC register (0800h, 0801h/0808h, 0809h) setup of SyncManager0/1 is inaccurate. - The area for reception of Mailbox overlaps the area for transmission. - The area for transmission/reception of Mailbox overlaps the area for transmission/reception of SyncManager2/3 - Address specification of the area for transmission/reception of Mailbox is odd number. - A Length:ESC register (0802h,0803h/080Ah, 080Bh) setup of SyncManager0/1 is inaccurate. - SyncManager0: Less than 32 byte - SyncManager1: Less than 32 byte - A Control Register:ESC register (0804h/080Ch) setup of SyncManager0/1 is inaccurate. - Other than 0110b is set for 0804h: bit3-0. - Other than 0010b is set for 080Ch: bit3-0. 	- Please set up Sync manager correctly.
	4	PDO watchdog error protection	<p>A setup of the watchdog timer of PDO is wrong.</p> <ul style="list-style-type: none"> - Although PDO watch dog trigger is effective (SyncManager: Bit6 which is the register 0804h set to 1), When the detection timeout value of PDO watchdog timer cycle setup (registers 0400h and 0420h) was the "communication cycle multiply 2" by DC and SM2 mode, was the following was set as less than 2 ms by FreeRun mode. 	- Set up detection timeout value of watchdog timer correctly.
	5	DC error protection	<p>DC setting setup is wrong.</p> <ul style="list-style-type: none"> - A value other than the following was set to bit 2-0 of 0981h (Activation) of the ESC register: bit 2-0 = 000b bit 2-0 = 011b 	- Check setting of DC mode.

(To be continued)

Error No.		Protective function	Causes	Measures
Main	Sub			
81	6	SM event mode error protection	<p>SM event mode which is not supported was set up.</p> <ul style="list-style-type: none"> - It was set to 1C32h-01h(Sync mode) at values other than 00h(FreeRun), 01h(SM2), and 02h(DC SYNC0). - A value other than 00h (FreeRun), 02h (DC SYNC0), or 22h (SM2) was set to 1C33h-01h (Sync mode). - 000b was set to bit 2-0 of 0981h of the ESC register and SM2 was set to only either 1C32h-01h or 1C33h-01h. 	<ul style="list-style-type: none"> - 1C32h-01h(Sync mode) should set up 00h(FreeRun), 01h(SM2), or 02h(DC SYNC0). - 1C33h-01h(Sync mode) should set up 00h (FreeRun), 02h (DC SYNC0), or 22h (SM2). - The setting of 1C32h-01h should be equal to that of 1C33h-01h.
	7	SyncManager2/3 error protection	<p>A setup of SyncManager2/3 was set as the unjust value.</p> <ul style="list-style-type: none"> - A Physical Start Address (ESC registersh 0810h) setting of SyncManager2 is inaccurate. - The area for reception overlaps the area for transmission. - The area for transmission/reception of Mailbox overlaps the area for transmission/reception of SyncManager2/3 - Address specification of the area for transmission/reception is odd number. - The start address is out of range. - A Length (ESC registersh 0812h) setting of SyncManager2 is inaccurate. - Different from RxPDO size. - A Control Register:ESC register (0814h) setting of SyncManager2 is inaccurate. - Other than 01b is set for bit3-2. - A Physical Start Address (ESC registersh 0818h) setting of SyncManager3 is inaccurate. - The area for reception overlaps the area for transmission. - The area for transmission/reception of Mailbox overlaps the area for transmission/reception of SyncManager2/3 - Address specification of the area for transmission/reception is odd number. - The start address is out of range. - A Length (ESC register 081Ah) setting of SyncManager3 is inaccurate. - Different from TxPDO size. - A Control Register:ESC register (081Ch) setting of SyncManager3 is inaccurate. - Other than 00b is set for bit3-2. 	<ul style="list-style-type: none"> - Set up SyncManager2/3 correctly.
84	3	Synchronous establishment initialization error protection	Error occurred during initialization process of phasing communication and servo.	<ul style="list-style-type: none"> • Turn off the power once, then re-enter. • If error repeats, this might be a failure. Stop using the products, and replace the motor and the driver. • Return the products to the dealer or manufacturer.
85	0	TxPDO assignment error protection	- When the data size of the TxPDO map is set up exceeding 32 bytes.	- TxPDO data size is set up within 32 bytes.
	1	RxPDO assignment error protection	- When the data size of the RxPDO map is set up exceeding 32 bytes.	- RxPDO data size is set up within 32 bytes.
	2	Lost link error protection	The time set in Pr7.43 (Lost link detection time) elapsed when either Port 0 or Port 1 fell and remains in the lost link state after the ESM state transitioned from Init to PreOP (not including a port that had been in the lost link state at the time of transition from Init to PreOP).	<ul style="list-style-type: none"> - Check whether there is any problem in wiring of EtherCAT communication cable. - Check whether there is any problem in the communication from higher rank equipment.

(To be continued)

Error No.		Protective function	Causes	Measures
Main	Sub			
85	3	SII EEPROM error protection	<ul style="list-style-type: none"> - VendorID, Product code, and Revision number do not agree between SII (EEPROM) and the object values. - Reading out from and writing to SII (EEPROM) are improper. - If any of bit11 to14 of ESC register 0502h is set to 1. 	<ul style="list-style-type: none"> - Check the data of SII. - Retry reading out from and writing to SII.
87	0	Forced alarm input protection	Forced alarm input (E-STOP) is applied.	Check the wiring of forced alarm input (E-STOP).
	1	Retracting operation completion (I/O)	The retracting operation by I/O is successfully completed.	<ul style="list-style-type: none"> - This is a security precaution, and there is no problem if it is an intended retracting operation. - It is an error that notifies the retracting operation execution.
	2	Retracting operation completion (communication)	The retracting operation by communication is successfully completed.	<ul style="list-style-type: none"> - Make sure that return to origin is performed after the alarm is cleared.
	3	Retracting operation error	<ul style="list-style-type: none"> - Retracting operation activation failed due to one of the following conditions. Otherwise, the retracting operation was suspended. - The setting for Pr6.85 “Retracting operation condition setting” is abnormal - The retracting operation is enabled and the communication cycle is less than 0.250 ms - Drive inhibit input (POT/NOT) is detected during the retracting operation - A retracting operation execution condition is satisfied although drive inhibit input (POT/NOT) has been detected - A retracting operation execution condition is satisfied during an operation not according to the communication command from the host device (such as test run) - The retracting operation was suspended in response to alarm detection during a retracting operation - Retracting operation activation failed due to a servo-off state and such 	<ul style="list-style-type: none"> - Confirm that there are no errors in parameter settings. - Confirm that there is no problem in the operating environment. - Make sure that return to origin is performed after the alarm is cleared.

(To be continued)

Error No.		Protective function	Causes	Measures
Main	Sub			
88	0	Main power undervoltage protection (AC insulation detection 2)	<ul style="list-style-type: none"> - Main circuit power supply OFF was detected when the preset value of 6007h (Abort connection option code) is 1 and the PDS state is "Operation Enabled" or "Quick stop active". - Switch on command was received when the preset value of 6007h (Abort connection option code) is 1 and the PDS state is "Ready to switch on" and main circuit power supply OFF. 	<ul style="list-style-type: none"> - The capacity rise of power supply voltage. A power supply is changed. The cause by which the magnetic contactor of the main power supply fell is removed, and a power supply is switched on again. - Each phase (L1, L2, L3) of a power supply is connected correctly. The single phase 100V and the single phase 200V should use L1 and L3. - It replaces with new servo driver.
	1	Control mode setting error protection	<ul style="list-style-type: none"> • PDS state was shifted to "Operation enabled" when the setting value in 6060h (Modes of operation) is 0 and the setting value in 6061h (Modes of operation display) is also 0. • A control mode which is not supported or a value outside the range was set in 6060h (Modes of operation). 	<ul style="list-style-type: none"> - Check the preset value of 6060h (Modes of operation).
	2	ESM requirements during operation error protection	<ul style="list-style-type: none"> - When PDS state was "Operation enabled" or "Quick stop active", received the ESM state change command to other ESM states. - When Pr7.99 bit0=1 is set, the command for transitioning from the current ESM to other ESM state was received during servo-on (while warning D2 is occurring) on PANATERM. 	<ul style="list-style-type: none"> Check the state transition request from host controller.
	3	Improper operation error protection	<ul style="list-style-type: none"> • When EXT1/EXT2 was selected in touch probe trigger selection (60B8h (Touch probe function)) while EXT1/EXT2 is not assigned as input signal • When wrap-around occurs in the actual position or command position while the software limit function is valid • When the operation result on electronic gear ratio is outside the range of 8000-fold to 1/1000-fold • When the denominator or numerator exceeds the unsigned 64-bit size during the electronic gear ratio operation process • When the denominator or numerator exceeds the unsigned 32-bit size in the electronic gear ratio final operation result 	<ul style="list-style-type: none"> - Set up the functional allotment for input signal correctly. - Set up trigger selection correctly. - Check the relation between the operation range setting and the software limit setting. - Review the electronic gear settings and turn ON the power again.

(To be continued)

Error No.		Protective function	Causes	Measures
Main	Sub			
92	1	Feedback scale data recovery error protection	Initialization processing of the internal positional information was not correctly executed when an absolute scale is used.	<ul style="list-style-type: none"> Regulate the power source of the feedback scale to 5 VDC $\pm 5\%$ (4.75–5.25 V)...Measure the voltage at the feedback scale connection cable end if it is long. If the motor cable and feedback scale connection cable are bundled together, separated them. Connect the shield to FG...See the feedback scale connection diagram. in Standard specification specification.
93	3	Feedback scale connection error protection	• The value set up for Pr3.23 (Feedback scale type select) does not match the feedback scale type of the connected serial communication.	• Set Pr 3.23 to the type of feedback scale connected.
	5	Parameter setup error protection 4	A value exceeding 0 was set in Pr6.102 "Setting of over-travel inhibition release level" when Pr5.04 "Over-travel inhibition input setting" was set to a value other than 1.	Check the parameter setting values.
	8	Parameter setup error protection 6	A carrier frequency that is not supported was set.	Check the parameter setting values.
94	3	Home position return error protection 2	<ul style="list-style-type: none"> When Pr7.22 bit7 = 1 and Pr5.04 = 0 or 1 (Pr5.04 is ignored under pp mode), POT or NOT has become ON while return operation to detected Z phase position at homing with Z phase. The return amount to the detected Z phase position became abnormal in Home position return which used Z phase. 	<ul style="list-style-type: none"> Expand the distance between Z phase and POT or NOT. After confirming the safety, it's made bit7 of Pr7.22 (Communication function extended setup 1) =0(Invalid).
96	2	Control unit error protection 1	An error occurred in the servo driver control unit.	<ul style="list-style-type: none"> Turn the power off and then on again. Return the products to the dealer or manufacturer.
	3	Control unit error protection 2		
	4	Control unit error protection 3		
	5	Control unit error protection 4		
	6	Control unit error protection 5		
	7	Control unit error protection 6		
	8	Control unit error protection 7		
98	2	Communication hardware error protection 2	Fault is determined in EtherCAT communication related peripheral device.	<ul style="list-style-type: none"> Turn off the power once, then re-enter. If error repeats, this might be a failure. Stop using the products, and replace the motor and the driver. Return the products to the dealer or manufacturer.
	3	Communication hardware error protection 3		
	5	Hardware self-diagnosis abnormality protection 1	The current detector has an abnormality.	Return to a dealer for investigation (repair).
Other No.		Other error protection	Control circuit has malfunctioned due to excess noise or other causes. Some error has occurred inside of the driver while triggering self-diagnosis function of the driver.	<ul style="list-style-type: none"> Turn off the power once, then re-enter. If error repeats, this might be a failure. Stop using the products, and replace the motor and the driver. Return the products to the dealer or manufacturer.

Overload protection time characteristics

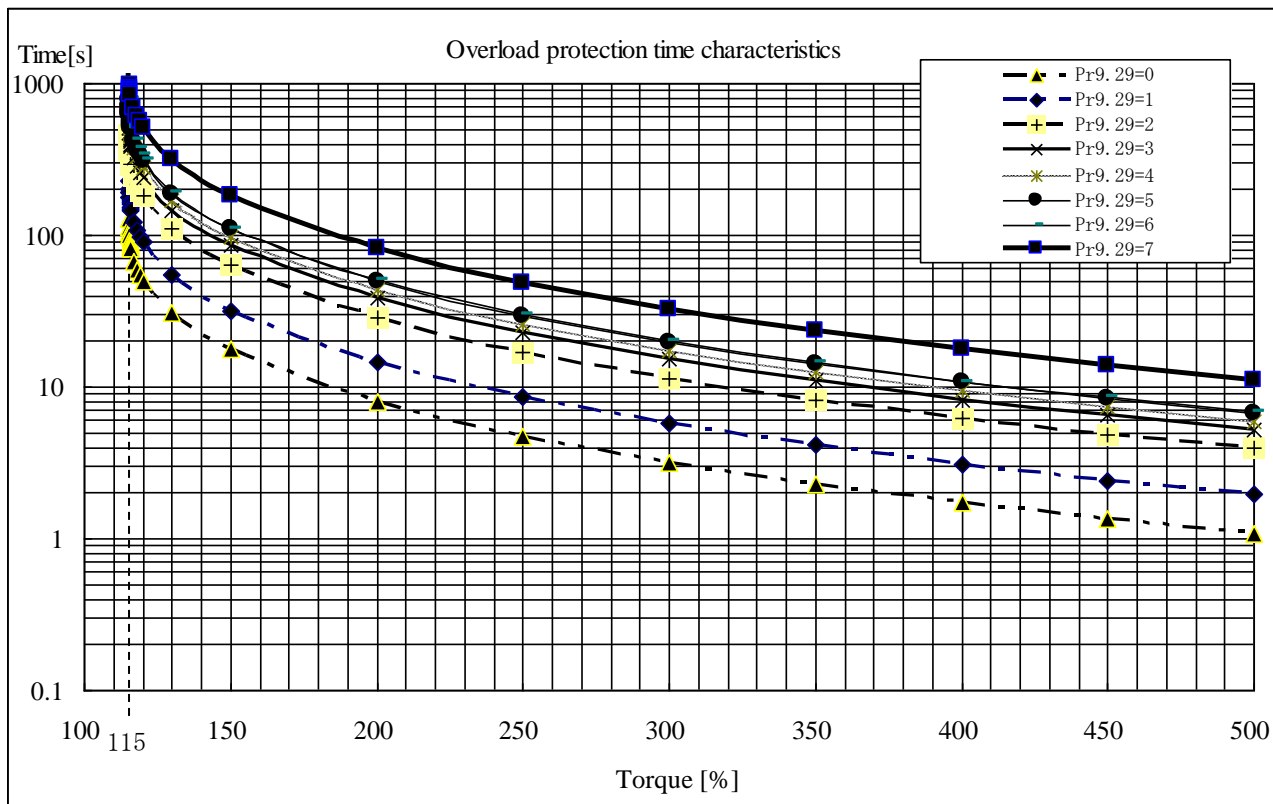

■ Relevant parameters

Class	No.	Attribute *1)	Title	Range	Unit	Function
9	29	R	Overload protection time characteristics setup	0-7	—	0: Standard specification Select the overload protection time characteristics above 8 characteristic.

*1) For parameter attributes, refer to Section 9-1.

Notes: Overload protection does not guarantee error protection due to motor heat buildup, for example. Before use, be sure to check that there are no problems due to motor heat buildup, for example, in the actual operation environment.

7-3 Warning function

The warning will be triggered before the protective function is activated, and you can check the conditions such as overload beforehand.

One of the following warning modes can be selected through the setting of Pr 6.27 Warning latch state setting: the warning non-latch mode in which the warning is automatically cleared 1 sec. after the cause of warning is removed, and the warning latch mode in which the warning is kept issued even after the cause of warning is removed. To clear the latched state, use the alarm clearing procedure described in previous alarm section.

(1) Relevant parameters

Class	No.	Attribute *1)	Title	Range	Unit	Function
4	40	A	Selection of alarm output 1	0-40	—	Select the type of warning issued as the warning output 1 (WARN1). Setup value 0: ORed output of all warnings. For 1 and subsequent see the table below.
4	41	A	Selection of alarm output 2	0-40	—	Select the type of warning issued as the warning output 2.(WARN2) Setup value 0: ORed output of all warnings. For 1 and subsequent see the table below.
6	27	C	Warning latch state setup	0-3	—	Set the latching state of warning. General warning and extended warning can be specified. bit 0: Extended warning 0: unlatch, 1: latch bit 1: General warning 0: unlatch, 1: latch
6	37	B	Oscillation detecting level	0-1000	0.1%	Set the threshold of oscillation detection. When torque vibration beyond this setting is detected, an oscillation detection alarm is activated. If the set value is 0, this function is disabled and the alarm is not activated.
6	38	R	Alarm mask setup	-32768 -32767	—	Set the warning detection mask. To disable detection of a warning, place 1 to the corresponding bit.
6	39	C	Alarm mask setup 2	-32768 -32767	—	
6	95 *2)	A	Over-load warning detection level	0-114	%	Sets the threshold value for detecting the warning as the overload factor increases. Sets with the overload factor. If 0 is set, overload warning detection is performed under conventional conditions (85% of overload protection level). In addition, if other than "Pr6.96 ≤ Pr6.95 < (Overload protection level)" is set, overload warning detection is performed under conventional conditions (85% of overload protection level).
6	96 *2)	A	Over-load warning release level	0-114	%	Sets the threshold value for releasing the warning when the load factor decreases from the state when the overload warning is occurring. Sets with the overload factor. If 0 is set, overload warning detection is performed under conventional conditions (85% of overload protection level). In addition, if other than "Pr6.96 ≤ Pr6.95 < (Overload protection level)" is set, overload warning detection is performed under conventional conditions (85% of overload protection level).
6	97	B	Function expansion setup 3	-2147483648 -2147483647	—	bit 1: Deterioration diagnosis warning function: 0: Invalid, 1: valid bit14: Over-travel inhibition warning 0: Invalid, 1: valid
7	14	C	Main power off warning detection time	0-2000	1 ms	Specifies a time to wait until a main power off warning is detected when main power shut-off continues. 0-9, 2000: Warning detection is disabled. 10-1999: Unit is [ms]

*1) For parameter attribute, refer to Section 9-1.

*2) The numbers of parameters for overload warning detection or release level are different from MINAS-A5BL series.

(2) Warning types

■ General warning

Warning No. (Hex.)	Warning	Content	Warning latch	Output setting	Warning mask																					
			Pr 6.27 *1)	Pr 4.40/ Pr 4.41 *2)	Pr 6.38/ Pr 6.39 Corresponding bit *3)																					
A0	Overload warning *6)	The specification for warning detection varies depending on the values of Pr6.95 (Over-load warning detection level) and Pr6.96 (Over-load warning release level), and it becomes as shown in the table below.	○ *6)	1	Pr 6.38 bit 7																					
		<table border="1"> <thead> <tr> <th>Pr6.95</th> <th>Pr6.96</th> <th>Pr6.95 Pr6.96 Relationship between magnitude</th> <th>warning detection specification</th> <th>warning release specification</th> <th>Remarks</th> </tr> </thead> <tbody> <tr> <td rowspan="2">Other than 0</td> <td rowspan="2">Other than 0</td> <td>Pr6.95\geq Pr6.96</td> <td rowspan="2">Load factor is Pr6.95 or more</td> <td rowspan="2">Load factor less than Pr6.96</td> <td>Extended specification</td> </tr> <tr> <td>Pr6.95$<$ Pr6.96</td> <td rowspan="2">Please do not set</td> </tr> <tr> <td rowspan="2">0</td> <td>Other than 0</td> <td rowspan="2">-</td> <td rowspan="2">Load factor is 85% or more of the protection level</td> <td rowspan="2">Load factor is less than 85% of the protection level</td> <td rowspan="2">Conventional specification</td> </tr> <tr> <td>0</td> </tr> </tbody> </table>				Pr6.95	Pr6.96	Pr6.95 Pr6.96 Relationship between magnitude	warning detection specification	warning release specification	Remarks	Other than 0	Other than 0	Pr6.95 \geq Pr6.96	Load factor is Pr6.95 or more	Load factor less than Pr6.96	Extended specification	Pr6.95 $<$ Pr6.96	Please do not set	0	Other than 0	-	Load factor is 85% or more of the protection level	Load factor is less than 85% of the protection level	Conventional specification	0
		Pr6.95				Pr6.96	Pr6.95 Pr6.96 Relationship between magnitude	warning detection specification	warning release specification	Remarks																
		Other than 0				Other than 0	Pr6.95 \geq Pr6.96	Load factor is Pr6.95 or more	Load factor less than Pr6.96	Extended specification																
							Pr6.95 $<$ Pr6.96			Please do not set																
0	Other than 0	-	Load factor is 85% or more of the protection level	Load factor is less than 85% of the protection level	Conventional specification																					
	0																									
A1	Over-regeneration warning	Regenerative load factor exceeded 85% of protection level.	○	2	Pr 6.38 bit 5																					
A3	Fan warning	Fan has stopped for 1 sec.	○	4	Pr 6.38 bit 6																					
A6	Oscillation detection warning	Oscillation or vibration is detected.	○	7	Pr 6.38 bit 13																					
A7	Lifetime detection warning	Life expectancy of capacitor or fan becomes short.	Latch fixed	8	Pr 6.38 bit 2																					
A8	Feedback scale error warning	The feedback scale detects the warning.	○	9	Pr6.38 bit 8																					
A9	Feedback scale communication warning	The number of successive feedback scale communication errors exceeds the specified value.	○	10	Pr6.38 bit 10																					
AC	Deterioration diagnosis warning *5)	Load characteristic estimates or torque command under constant speed has exceeded the set range.	○	22	Pr6.39 bit7																					

■ Extended warning

Warning No. (Hex.)	Warning	Content	Warning latch	Output setting	Warning mask
			Pr 6.27 *1)	Pr 4.40/ Pr 4.41 *2)	Pr6.38/Pr6.39 Corresponding bit *3)
C3	Main power off warning	When setting of Pr7.14 (Main power off warning detection time) is 10-1999, instantaneous power interruption occurs between L1 and L3 and lasts for a time longer than the setting of Pr7.14.	○	14	Pr 6.38 bit 12
D2	PANATERM command execution warning	When bit0 of Pr7.99"Communication function Extended setup 6" is 1 and EtherCAT communication is established, the operation command (such as test run and FFT) by setup support software (PANATERM) is executed.	○	30	Pr6.39 bit8
D3	Over-travel inhibition warning *7)	Entered the over-travel inhibition state.	○	31	Pr6.39 bit9

- *1) The mark circle indicates that the warning status can be maintained or cleared by the setting of Pr 6.27 "Warning latch state setup". Battery warning and lifetime detection warning will be in the latch mode only.
- *2) Select the warning output signal 1 (WARN 1) or warning output signal 2 (WARN 2) through Pr 4.40 "Warning output select 1" or Pr 4.41 "Warning output select 2". When the set value is 0, all warnings are ORed before being output. Do not set to any value other than those specified in the table above.
- *3) A warning detection can be disabled through Pr 6.38 "Warning mask setup" or Pr 6.39 "Warning mask setup 2", by setting the bit shown above to 1.
Also note that bit arrangements of these masks are different from MINAS-A6S series (ex. MINAS-A6SE).
- *4) The warning can be cleared by the alarm clearing operation.
If the cause of the warning is not yet removed, the warning will be detected again after clearing.
When an external alarm clear (A-CLR) is in the ON state, the warning does not occur.
- *5) Invalidated when Pr6.97 "Function expansion setup 3" bit1 = 0.
- *6) Settings of Pr6.95 and Pr6.96 allow you to enable the expansion specification of overload warning detection.
- *7) It is disabled when Pr6.97 "Function expansion setting 3" bit14 is set to 0.
It occurs only when 1 is specified for Pr5.04 "Over-travel inhibition input setting".

- Expansion specification enabled under “Pr6.95 and Pr6.96 are other than 0” and “Pr6.96 ≤ Pr6.95” and “Pr6.95 < Pr5.12”
In this specification, the warning latch function is invalid.

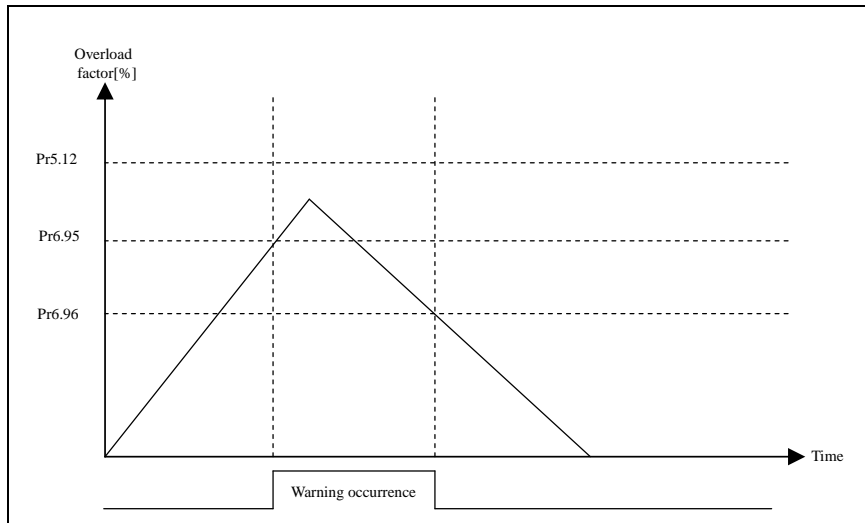

- Conventional specification enabled under conditions other than the above one.
In this specification, the warning latch function depends on the Pr6.27 setting.

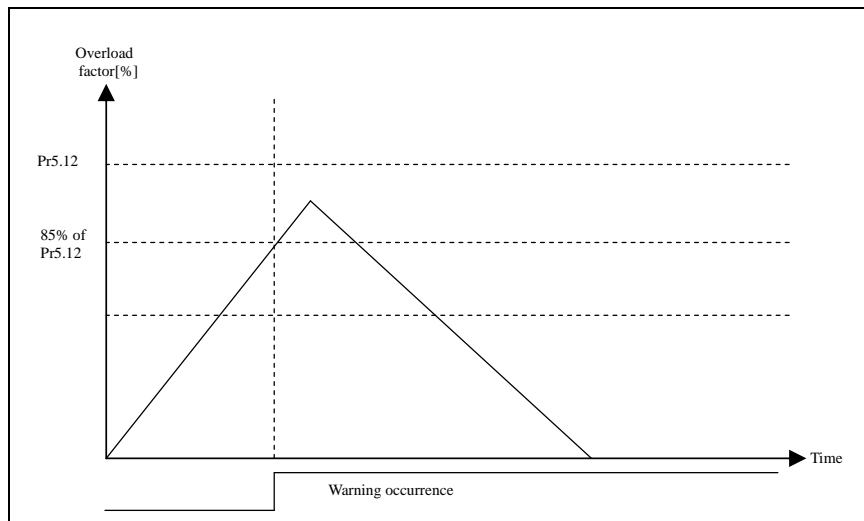

If switch to the extended specification by changing the set value of Pr 6.95 or Pr 6.96 during the overload warning with the warning latch function enabled, the overload warning may be cleared because the warning latch function become invalid.

(Note)

The numbers of parameters for overload detecting or releasing warning level are different from MINAS-A5BL series.

7-4 Setup of gain pre-adjustment protection

Before starting gain adjustment, set the following parameters based on the conditions of use, to assure safe operation.

1) Setup of over-travel inhibit input

By inputting the limit sensor signal to the driver, the bumping against mechanical end can be prevented. Refer to interface specification, positive/negative direction overtravel inhibit input (POT/NOT). Set the following parameters which are related to overtravel inhibit input.

Pr 5.04 Setup of over-travel inhibit input

Pr 5.05 Sequence at over-travel inhibit

2) Setup of torque limit

By limiting motor maximum torque, damage caused by failure or disturbance such as bite of the machine and collision will be minimized. To uniformly limit maximum torque by using the parameter Pr 0.13 1st torque limit, first set Pr 5.21 Selection of torque limit to 0 or 1.

If the torque limit setup is lower than the value required during the actual application, the following two protective features will be triggered: over-speed protection when overshoot occurs, and excess positional deviation protection when response to the command delays.

By allocating the torque in-limit output (TLC) of interface specification to the output signal, torque limit condition can be detected externally.

3) Setup of over-speed protection

Generates Err 26.0 Over-speed protection when the motor speed is excessively high.

Default setting is the applicable motor over-speed level.

If your application operates below the motor maximum speed, set Pr 5.13 Setup of over-speed level by using the formula below.

Pr 5.13 Setup of over-speed level = $V_{max} \times (1.2 \text{ to } 1.5)$

V_{max} : motor maximum speed [r/min] in operating condition

Factor in () is margin to prevent frequent activation of over-speed protection.

When running the motor at a low speed during initial adjustment stage, setup the overspeed protection by multiplying the adjusting speed by a certain margin to protect the motor against possible oscillation.

4) Setup of the excess positional deviation protection

During the position control, this function detects potential excessive difference between the positional command and motor position and issues Err 24.0 "Excess positional deviation protection".

Excess positional deviation level can be set to Pr 0.14 "Position deviation excess setup". The deviation can be detected through command positional deviation [pulse (command unit)] and feedback scale positional deviation [pulse (feedback scale unit)], and one of which can be selected by Pr 5.20 "Position setup unit select". (See the control block diagram.)

Because the positional deviation during normal operation depends on the operating speed and gain setting, fill the equation below based on your operating condition and input the resulting value to Pr 0.14.

4-1) In case two degree-of-freedom is set to valid (Pr6.47 bit 0 = 1)

■ For Pr5.20 = 0 (Detection by command position deviation)

➤ Using command positional deviation (after filter) (Pr7.23 bit14=0)

* In this case, the position deviation cannot be obtained through calculation formula. Set the value including allowance, by estimating the maximum value of command position deviation (Pmax) from the actual operation waveform that could be used.

$$\text{Pr0.14 (Setup of positional deviation excess)} = P_{\text{max}} \times (1.2 \text{ to } 2.0)$$

Factor in () is margin to prevent frequent activation of excess positional deviation protection.

➤ Using command positional deviation (before filter) (Pr7.23 bit14=1)

$$\text{Pr0.14 (Setup of positional deviation excess)} = (P1 + P2 + P3 + P4) \times (1.2 \text{ to } 2.0)$$

Factor in () is margin to prevent frequent activation of excess positional deviation protection.

Position command smoothing (second-order) accumulator pulse count

$$: P1 = Vc \times (\text{set value for Pr2.22} / 10000) \times 2$$

Position command FIR filter accumulator pulse count : P2 = Vc × (set value for Pr2.23 / 10000) / 2

Adjustment filter accumulator pulse count : P3 = Vc × (set value for Pr6.48 / 10000)

Damping filter accumulator pulse count : P4 = Vc / (π × damping frequency [Hz])

- Vc : maximum frequency of positional command pulse [pulse (command unit)/s]
- Damping frequency is 1/10 of the set values for Pr2.14 (first), Pr2.16 (second), Pr2.18 (third) and Pr2.20 (fourth) and is calculated only when the set values are effective. In case multiple damping controls are valid, P4 shall be calculated for each damping filter and P4 shall be the total of the calculated values.

■ For Pr5.20 = 1 (Detection by feedback scale position deviation)

* In this case, the position deviation cannot be obtained through calculation formula. Set the value including allowance, by estimating the maximum value of feedback scale position deviation (Pmax) from the actual operation waveform that could be used.

$$\text{Pr0.14 (Setup of positional deviation excess)} = P_{\text{max}} \times (1.2 \text{ to } 2.0)$$

Factor in () is margin to prevent frequent activation of excess positional deviation protection.

- Measure with the smallest value when switching position loop gain Kp.
- Setting of command filter and damping control will not have any effect in case Pr 5.20 = 1.

4-2) In case two degree-of-freedom control is invalid (Pr6.47 bit 0 = 0)

■ For Pr5.20 = 0 (Detection by command position deviation)

- Using command positional deviation (after filter) (Pr7.23 bit14=0)

$$\text{Pr0.14 (Setup of positional deviation excess)} = P1 \times (1.2 \text{ to } 2.0)$$

Factor in () is margin to prevent frequent activation of excess positional deviation protection.

$$\text{Command positional deviation} : P1 = Vc / Kp \times ((100 - (\text{set value for Pr1.10} / 10)) / 100)$$

- Vc : maximum frequency of positional command pulse [pulse (command unit)/s]
- Kp : Position loop gain [1/s] (When switching position loop gain Kp, select the smallest value for calculation.)

- Using command positional deviation (before filter) (Pr7.23 bit14=1)

$$\text{Pr0.14 (Setup of positional deviation excess)} = (P1 + P2 + P3 + P4) \times (1.2 \text{ to } 2.0)$$

Factor in () is margin to prevent frequent activation of excess positional deviation protection.

$$\text{Command positional deviation} : P1 = Vc / Kp \times ((100 - (\text{set value for Pr1.10} / 10)) / 100)$$

Position command smoothing (first-order) accumulator pulse count

$$: P2 = Vc \times (\text{set value for Pr2.22} / 10000)$$

Position command FIR filter accumulator pulse count : P3 = Vc × (set value for Pr2.23 / 10000) / 2

Damping filter accumulator pulse count : P4 = Vc / (π × damping frequency [Hz])

- Vc : maximum frequency of positional command pulse [pulse (command unit)/s]
- Kp : Position loop gain [1/s] (When switching position loop gain Kp, select the smallest value for calculation.)
- Damping frequency is 1/10 of the set values for Pr2.14 (first), Pr2.16 (second), Pr2.18 (third) and Pr2.20 (fourth) and is calculated only when the set values are effective. In case multiple damping controls are valid, P4 shall be calculated for each damping filter and P4 shall be the total of the calculated values.

■ For Pr5.20 = 1 (Detection by feedback scale position deviation)

$$\text{Pr0.14 (Setup of positional deviation excess)} = P1 \times (1.2 \text{ to } 2.0)$$

Factor in () is margin to prevent frequent activation of excess positional deviation protection.

$$\text{Feedback scale position deviation} : P1 = Ve / Kp \times ((100 - (\text{set value for Pr1.10} / 10)) / 100)$$

- Ve : Maximum operation frequency [pulse/s] in feedback scale unit
- Kp : Position loop gain [1/s] (When switching position loop gain Kp, select the smallest value for calculation.)
- Setting of command filter and damping control will not have any effect in case Pr 5.20 = 1.

Notes: When switching from the velocity control to position control, position deviation correcting function is used, which will increase calculation value and error. To cope with these problems, increase the margin.

5) Setup of motor working range

During the position control, this function detects the motor position which exceeds the revolutions set to Pr 5.14 Motor working range setup, and issues Err 34.0 Software limit protection.

For details, refer to 6-2 Motor working range setup function.

7-5 About the protection function setting for homing return by using the Z phase

If the following parameters are set, the driver can detect inputting of over-travel inhibition (POT, NOT) during homing return to the Z phase detection position, which is treated as the origin with the operation for homing return by the Z phase.

If inputting of over-travel inhibition is detected during the return operation,

Err94.3 (returning to origin error protection 2) occurs, and the motor electricity is cut off, and it is stopped.

Pr7.22 bit7 (Communication function extended setup 1 (In Z phase homing Over-travel inhibit input setup)) =1

(Note)

- If the above value is set to the parameter and the Z phase in the vicinity of inputting of over-travel inhibition (POT/NOT) is configured as the origin, Err94.3 may be erroneously detected because overshoot occurs while returning to the Z phase detection position treated as the origin.
In that case, please away the Z phase of the homing completion position from inputting of over-travel inhibition (POT/NOT), homing return near inputting of over-travel inhibition (POT/NOT) so as not to occur.

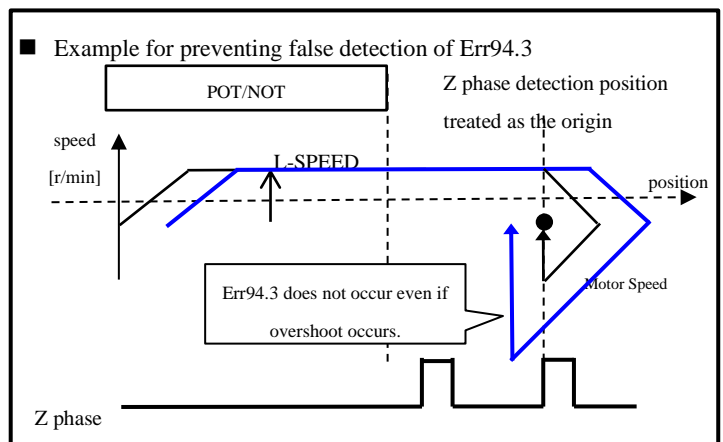
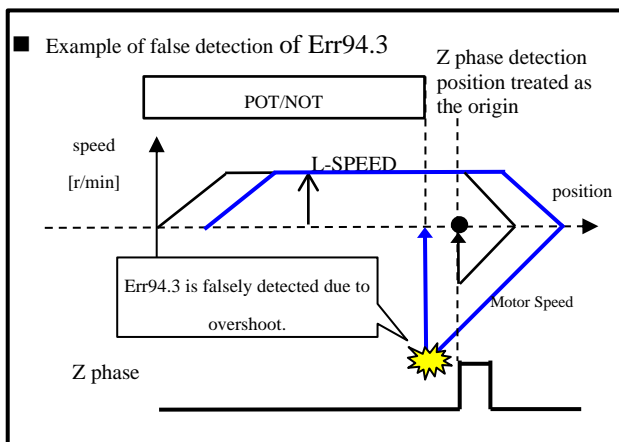

- If the above value is not set for the parameter, detection of inputting of over-travel inhibition (POT/NOT) during returning to the Z phase detection position, which is treated as the origin when returning to the origin by the Z phase, is disabled.

(1) Relevant parameters

Class	No.	Attribute *1)	Title	Range	Unit	Function
5	04	C	Over-travel inhibit input setup	0-2	—	<p>Set up the operation of the run-inhibition (POT, NOT) inputs. Normally it should be set to 1.</p> <p>0: Deceleration stop on servo (MINAS-A6) side (sequence upon inputting over-travel inhibition) POT -> inhibits positive direction drive, NOT -> inhibits negative direction drive. When POT is input during positive direction driving, stops the drive according to Pr 5.05 Sequence at over-travel inhibit. The similar function NOT is applied in reverse direction.</p> <p>1: CoE (CiA402) side deceleration stop POT -> inhibits positive direction drive, NOT -> inhibits negative direction drive. When POT is input during positive direction driving, or NOT is input during negative direction driving, EtherCAT profile slowdown defined in CoE(CiA402) works and stops it. The constants at the slowdown differ for every control mode.</p> <p>2: Deceleration stop on servo (MINAS-A6) side (sequence at alarm) POT or NOT input activates Err 38.0 Run-inhibition input protection.</p>
7	22	R	Communication function extended setup 1	-32768-32767	—	bit7 : In Z phase homing Over-travel inhibit input setup 0 : Invalid 1 : valid

*1) For parameter attribute, refer to Section 9-1.

(2) protective function

Error No.		Protective function	Causes	Measures
Main	Sub			
94	3	Home position return error2	<ul style="list-style-type: none"> When Pr7.22 bit7 = 1 and Pr5.04 = 0 or 1 (Pr5.04 is ignored under pp mode), POT or NOT has become ON while return operation to detected Z phase position at homing with Z phase. The return amount to the detected Z phase position became abnormal in Home position return which used Z phase. 	<ul style="list-style-type: none"> Expand the distance between Z phase and POT or NOT. After confirming the safety, it's made bit7 of Pr7.22 (Communication function extended setup 1) =0(Invalid).

8. Safety function

Available for [A6BM](ending with:M) only. It cannot be used in [A6BL](ending with:L)

This servo driver has safety function.

《Change point from MINAS-A5BL series》

	MINAS-A5BM	MINAS-A6BM	
STO operation	Alarm generation (Err30.0)	No alarm (7-segment LED is "St")	
Release method of STO state	Release STO factor and Alarm clear	After the STO state status When the alarm is not generated	After the STO state status When the alarm is generated
		Release of the factors of STO and PSD state is switch on disabled	Release of the factors of STO/alarm and Alarm clear

8-1 Outline of safe torque off (STO) function

The safe torque off (STO) function is a safety function that shuts the motor current and turns off motor output torque by forcibly turning off the driving signal of the servo driver internal power transistor. For this purpose, the STO uses safety input signal and hardware (circuit).

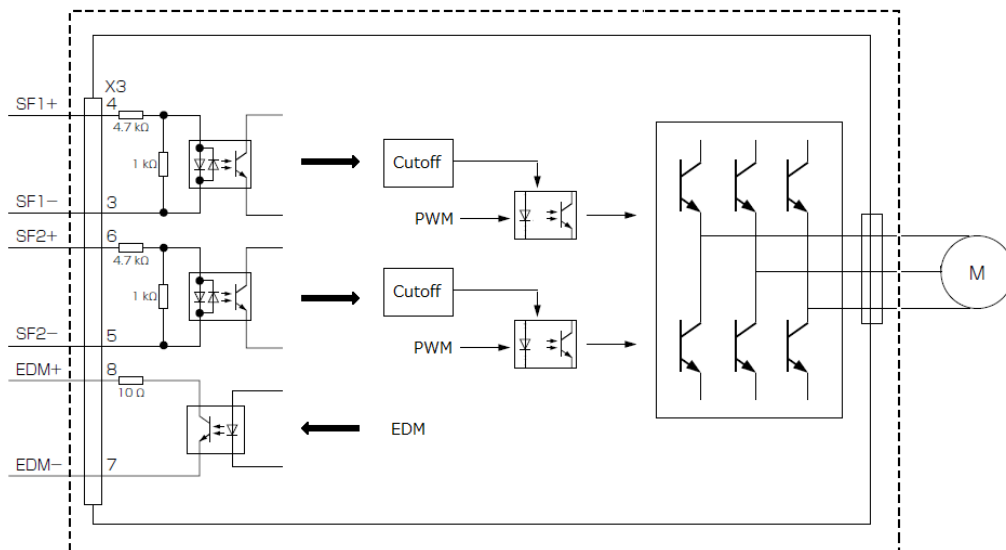

When STO is activated, the servo driver turns off the servo-ready output signal (S-RDY) and goes into a STO state, with the indication in the front panel turning to "St". When STO input is released and servo-on input is Off, it will automatically transition itself to Servo ready state.

In the case of the STO state, the position deviation is cleared to 0.

PDS state becomes switch on disabled, and ESM state will not shift.

Note 1) Difference in operation compared to MINAS-A5BL series:

Even if STO function is activated, it will not go into an alarm state, unlike the A5BL series.

When safety function detects an error, it will trigger an alarm (Err31.0, Err31.2)

8-2 Input/output signal specification

8-2-1 Safety input signal

- Two safety input circuit channels that trigger STO function are provided.

Class	Signal name	Signal	Connector pin number	Content	Control mode		
					Position	Velocity	Torque
Input	Safety input 1	SF1 +	X3-4	<ul style="list-style-type: none"> It is input 1 that triggers STO function. This input turns off the upper arm drive signal of power transistor. When using the function, connect this pin in a way so that the photocoupler of this input circuit turns off to activate STO function. 	○		
		SF1 -	X3-3				
	Safety input 2	SF2 +	X3-6	<ul style="list-style-type: none"> It is input 2 that triggers STO function. This input turns off the lower arm drive signal of power transistor. When using the function, connect this pin in a way so that the photocoupler of this input circuit turns off to activate STO function. 			
		SF2 -	X3-5				

- Safety input 1 or 2 enables STO to operate within 5 ms after input, and then the motor output torque will be turned off.
- Input the same signal to Safety input 1 and 2.

NOTE) Safety equipment self-diagnosis L pulse

The safety output signal from the safety equipment such as safety controller and safety sensor may include L pulse for self-diagnosis. To prevent the L pulse from mis-triggering STO function, the safety input circuit has built-in filter that removes the self-diagnosis L pulse.

Therefore, if the off period of safety input signal less than 1 ms, the safety input circuit does not detect this off event.

To validate this off period, turn off the safety input signal for more than 5 ms.

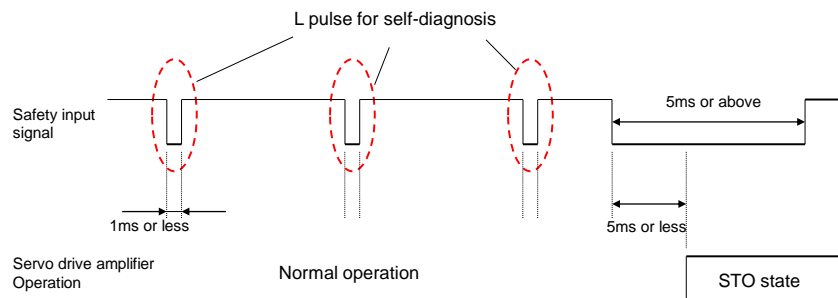

8-2-2 External device monitor (EDM) output signal

- The monitor output signal is used by the external device to monitor the state of the safety input signal. Be sure to connect the monitor output to the external device monitor terminal of the safety equipment such as safety controller and safety sensor.

Class	Signal name	Signal	Connector pin number	Content	Control mode		
					Position	Velocity	Torque
Output	EDM output	EDM +	X3-8	• Output monitor signal that is used to check the safety function.			○
		EDM-	X3-7				

- Logical relationship between safety input signal and EDM output signal is as follows. Under normal conditions, when both safety input 1 and 2 are off, i.e. when STO function of 2 safety input channels are active, the photocoupler in EDM output circuit turns on.

Signal name	Signal	Photocoupler logic			
Safety input	SF1	ON	ON	OFF	OFF
	SF2	ON	OFF	ON	OFF
EDM output	EDM	OFF	OFF	OFF	ON

By monitoring the logics (all 4 states) of photocoupler shown in the table above, the external device can determine the status (normal or abnormal) of safety input circuit and EDM output circuit. That is to say, in the case of an anomaly, although both safety input 1 and 2 are off, the photocoupler in EDM output circuit does not turn on. Or, although either safety input 1 or 2 or both safety input 1 and 2 turned on, the state in which the photocoupler in EDM output circuit turned on has been detected.

- Maximum delay time from input of safety 1 and 2 signals to output of EDM signal is 6 ms.
- In order to satisfy all the specification of functional safety, it is necessary to monitor the EDM signal with the host controller.
- Be sure to monitor the EDM signal at starting up the driver, every 3 months, and safety input.

8-3 Description of functions

8-3-1 Activation to STO state, timing diagram

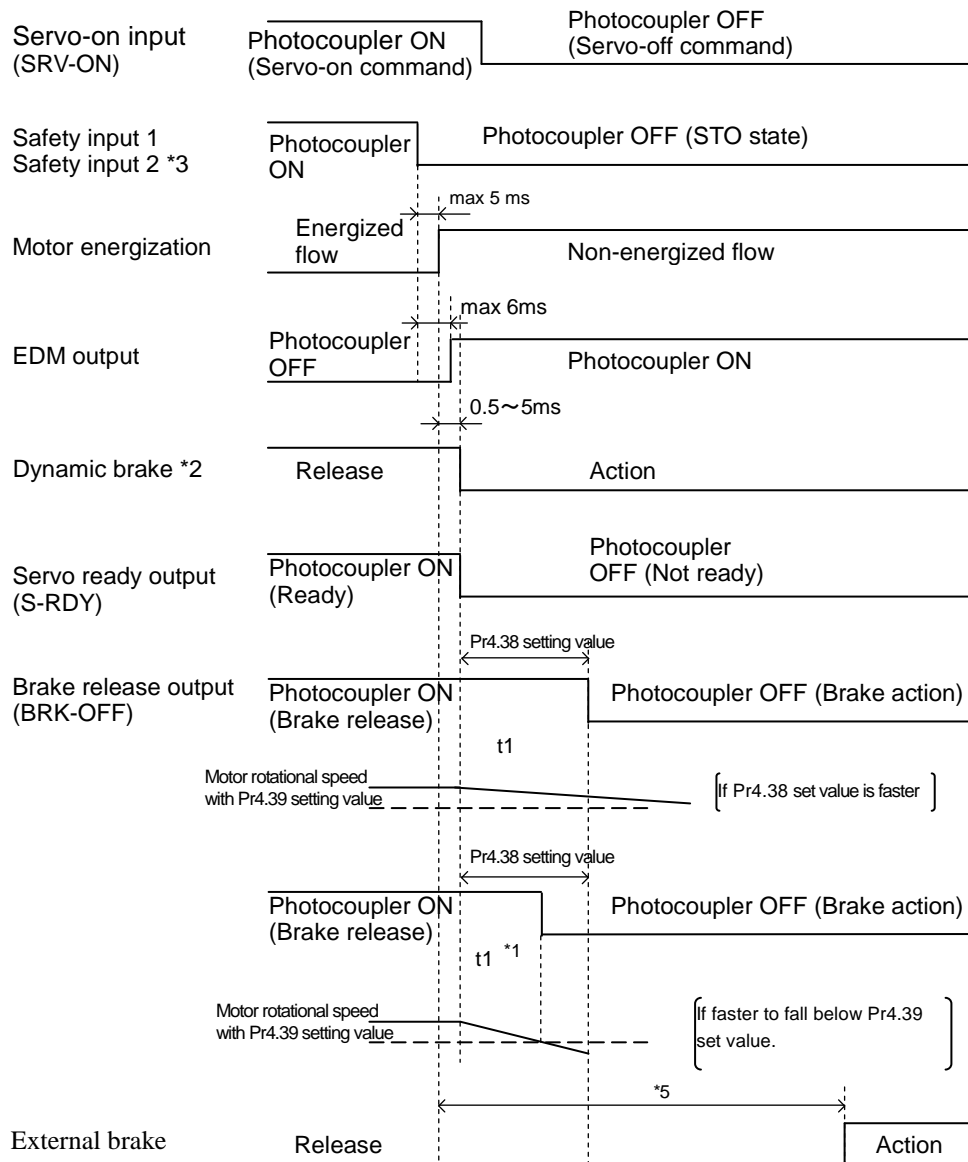

- *1. $t1$ will be a shorter time of either the setup value of Pr4.38 “Mechanical brake action at running setup” or elapsing time for the motor speed to fall below Pr4.39 “Brake release speed setup.”
- *2. Dynamic brake operates to the setting of Pr5.10 Sequence at alarm.
(In STO state, even if an alarm does not occur, “Sequence at alarm” is applied.)
- *3. To work STO function, please turn off safety input 1 and 2 at the same time.
- *4. The driver will not enter an alarm state.
- *5. Since servo-lock cannot be performed in the interval after motor energization is cut off until the external brake operates, the work may fall by gravity from the vertical axis. Take an appropriate measure to prevent this.

8-3-2 Return timing diagram from STO state

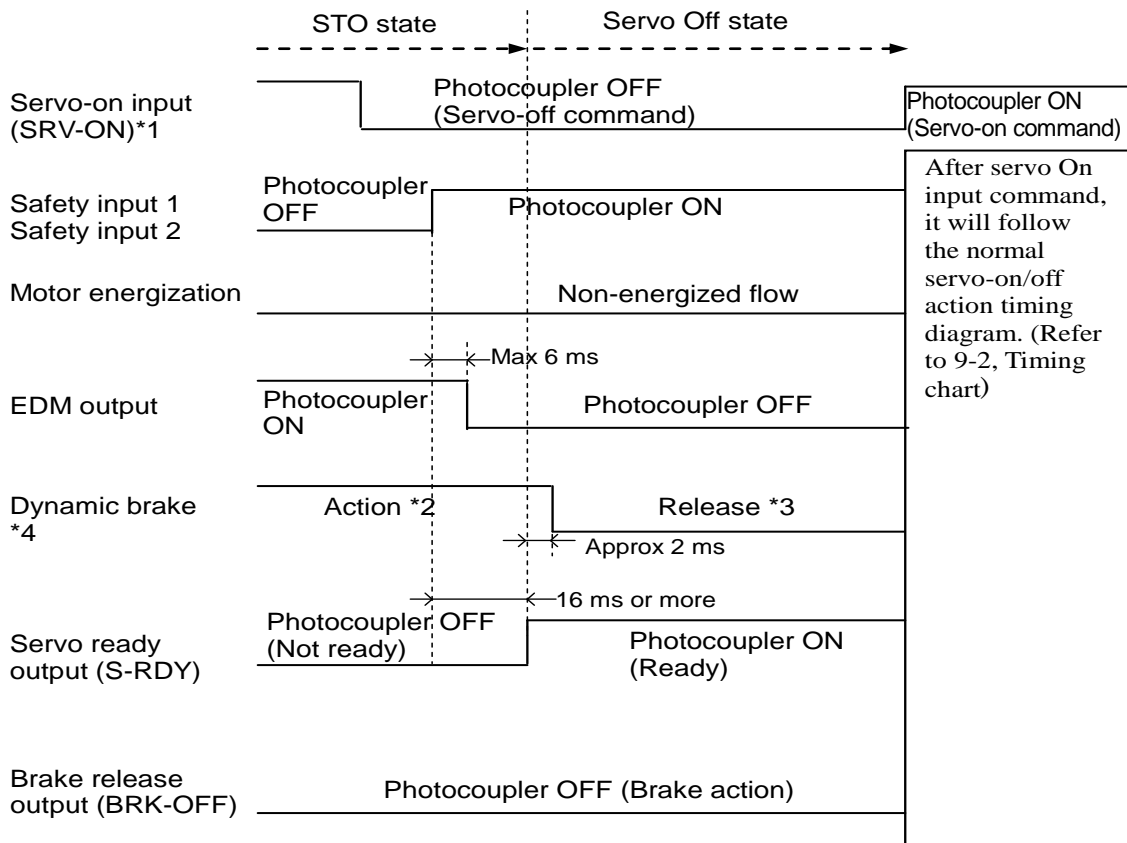

- *1. Photocouplers for safety input 1 and 2 should be turned on again with servo-on input turned off. Returning photocouplers for safety inputs 1 and 2 to ON will automatically reset it to Servo ready mode. There is no need to conduct alarm-clear.
- *2. This is an STO state and the dynamic brake operates according to Pr5.10 "Sequence at alarm." (In STO state, even if an alarm does not occur, "Sequence at alarm" is applied.)
- *3. This is normal servo-off condition and the dynamic brake operates according to Pr5.06 "Sequence at servo-off."

8-4 Connection example

« Attention point when connecting »

- Depending on the safety device to be connected, it is necessary to turn on the power supply of the driver first. At this time, the state of the driver becomes an alarm in MINAS-A5 series, becomes STO state in MINAS-A6 series.

The method of returning from the alarm state or STO state is as follows.

« MINAS-A5 series »

- ① Turn off servo ON command
- ② Return the photo couplers for safety input 1 and 2 to ON.
- ③ Release the alarm.

« MINAS-A6 series »

- ① Turn off servo ON command
 - ② Return the photo couplers for safety input 1 and 2 to ON.
- * Automatically return to the servo ready state.

8-4-1 Example of connection to safety switch

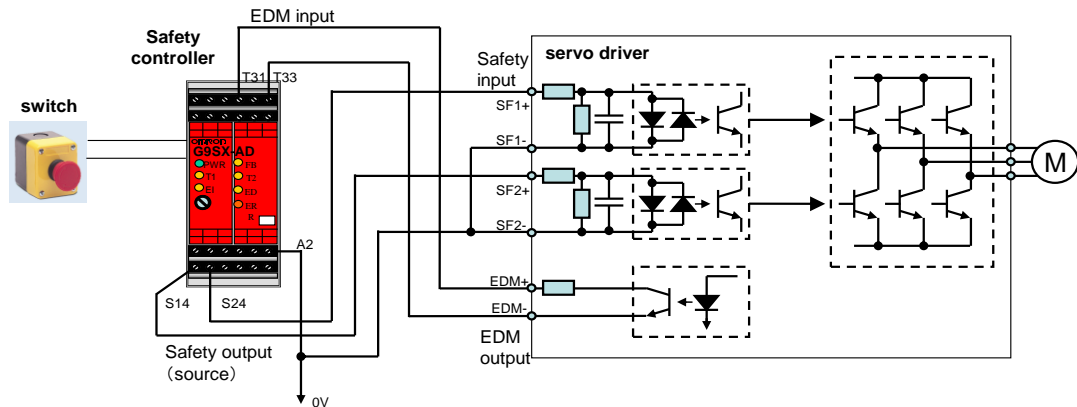

8-4-2 Example of connection when using multiple axes

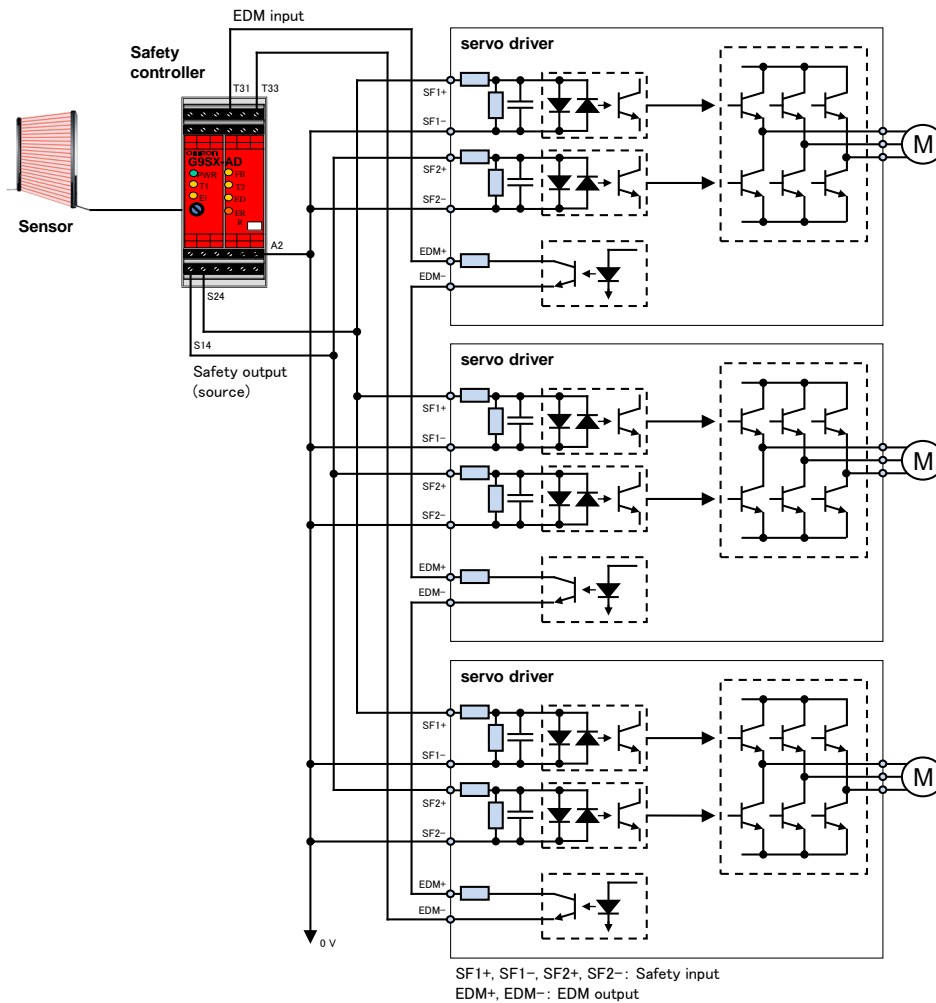

- Capacity requirement per safety output (source) channel: $5 \times \text{No. of connected axes}$ (mA)
- DC 24 V supply allowable voltage: $24 \text{ V} \pm 15 \%$
- Maximum No. of connectable axes: 8 axes *1

*1. The value is for reference.

When connecting EDM output in series, since the collector saturation voltage $V_{ce}(\text{sat})$ of the built-in photocoupler is approx. 1 V, the maximum number of connectable axes is limited. This $V_{ce}(\text{sat})$ changes depending on the collector current.

In addition, since approx. 5 mA per circuit is carried to SF input, as the number of connected axes increases, this current increases proportionally. It is required to limit the number of connected axes in order to prevent from exceeding the maximum output current on the safety controller side.

8-5 Safety precautions

- When using the STO function, be sure to perform equipment risk assessment to ensure that the system conforms to the safety requirements.
For use in the state not satisfying the safety requirement function, in some cases personal injury may result.
- Even while the STO function is working, the following potential safety hazards exist. Check safety in risk assessment.
Incorrect use may cause personal injury in some cases.
 - The motor may move when external force (e.g. gravity force on vertical axis) is exerted on it. Provide an external brake, etc., as necessary to secure the motor. Note that the purpose of servo motor with brake is holding and it cannot be used for braking application.
 - When parameter Pr5.10 “Sequence at alarm” is set to free run (disable dynamic brake), the motor is free run state and requires longer stop distance even if no external force is applied. Make sure that this does not cause any problem.
(In STO state, even if an alarm does not occur, “Sequence at alarm” is applied.)
 - When power transistor, etc., becomes defective, the motor will move about 180 degrees in electrical angle. Make sure that this does not cause any problem.
 - The STO turns off the current to the motor but does not turn off power to the servo driver and does not isolate it. When starting maintenance service on the servo driver, turn off the driver by using a different disconnecting device.
- EDM output signal is not a safety output. Do not use it for an application other than failure monitoring.
Incorrect use may cause personal injury in some cases.
- Dynamic brake and external brake release signal output are not related to safety function. When designing the system, make sure that the failure of external brake release during STO state does not result in danger condition.
Incorrect use may cause personal injury in some cases.
- When using the STO function, connect equipment conforming to the safety standards.
Use of equipment not compliant with safety standards, in some cases personal injury may result.

9. Other

9-1 List of parameters

The attribute of a parameter indicates the point at which the modified parameter setting becomes effective.

A : Always effective

B : Do not change while the motor is operating or command is transferred.

Changes while the motor is operating or command is transferred may result in transiently unstable operation and should be avoided as much as possible.

C : Effective after reset control power or after pin assign setting from PANATERM

R : Effective after reset control power

X : Read only - It cannot be changed using the normal procedure.

9-1-1 Class 0: Basic setting

Class	No.	Title	Unit	Range	Size [byte]	Function / Contents	Attribute	Related control mode	Reference
0	00	For manufacturer's use	—	—	2	Permanently set at 1.	—	—	—
	01	For manufacturer's use	—	—	—	Permanently set at 0.	—	—	—
	02	Real-time auto-gain tuning setup	—	0-6	2	You can set up the action mode of the real-time auto-gain tuning.	B	All	5-1-1 5-1-2 5-1-3
	03	Real-time auto-tuning machine stiffness setup	—	0-31	2	Set the machine stiffness during real-time auto-gain tuning.	B	All	5-1-1 5-1-2 5-1-3
	04	Inertia ratio	%	0-20000	2	You can set up the ratio of the load inertia against the rotor (of the motor) inertia.	B	All	—
	08	For manufacturer's use	—	—	4	Permanently set at 0.	—	—	—
	09	For manufacturer's use	—	—	4	Permanently set at 1.	—	—	—
	10	For manufacturer's use	—	—	4	Permanently set at 1.	—	—	—
	11	Numerator of pulse output division	pulse/r	1-2097152	4	Set the numerator of pulse output division.	R	All	4-2-5
	12	Reversal of pulse output logic/output source selection	—	0-3	2	You can set up the B-phase logic and the output source of the pulse output.	R	All	4-2-5
	13	1st torque limit	%	0-500	2	You can set up the 1st limit value of the motor output torque. In addition, the actual torque applied is limited with the maximum torque limit for the motor applied. (The parameter value is not limited) Note that the maximum torque limit for the motor applied can be calculated according to the expression given below. Maximum torque limit [%] $= 100 \times \text{Pr } 9.07 / (\text{Pr } 9.06 \times \sqrt{2})$.	B	All	6-1 7-4
	14	Position deviation excess setup	command unit	0-2 ³⁰	4	Set excess range of positional deviation by the command unit.Err24.0 (Error detection of position deviation excess) becomes invalid when it set up this to 0.Unit is according to Pr5.20 (Position setup unit select). The shipping set value is equivalent to 10 rotations when the command pluse per rotation is 23-bits.	A	Position,	7-4
	15	For manufacturer's use	—	—	—	Permanently set at 1.	—	—	—
16	External regenerative resistor setup	—	0-3	2	Set up items related to regenerative resistor. ※Please do not change the shipment value setting with V frame.	C	All	4-5	
17	Selection of load factor for external regenerative resistor	—	0-4	2	Select the computation method of loading factor for external regenerative resistor. ※Please do not change the shipment value setting with V frame.	C	All	4-5	
18	For manufacturer's use	-	-	2	Permanently set at 0.	-	-	-	
23	Hardware identification information	—	-2147483648 - 2147483647	4	Displays the hardware identification information for the product. (For manufacturer's use)	X	All	—	

9-1-2 Class 1: Gain adjustment

Class	No.	Title	Unit	Range	Size [byte]	Function / Contents	Attribute	Related control mode	Reference
1	00	1st gain of position loop	0.1/s	0-30000	2	Set the 1st gain of position loop.	B	Position,	5-2
	01	1st velocity loop gain	0.1 Hz	1-32767	2	Set the 1st gain of velocity loop.	B	All	5-2
	02	1st velocity loop integration time constant	0.1 ms	1-10000	2	Set the 1st velocity loop integration time constant. Keep integration if setting value is 9999. Becomes invalid if setting value is 10000.	B	All	5-2
	03	1st filter of velocity detection	-	0-5	2	Set the 1st velocity detection filter to one of 6 levels.	B	All	5-2
	04	1st torque filter time constant	0.01 ms	0-2500	2	Set the time constant of the 1st torque filter.	B	All	5-2
	05	2nd gain of position loop	0.1/s	0-30000	2	Set the 2nd position loop gain.	B	Position,	5-2
	06	2nd velocity loop gain	0.1 Hz	1-32767	2	Set the 2nd velocity proportional gain.	B	All	5-2
	07	2nd velocity loop integration time constant	0.1 ms	1-10000	2	Set the 2nd velocity integration time constant. Keep integration if setting value is 9999. Becomes invalid if setting value is 10000.	B	All	5-2
	08	2nd filter of velocity detection	-	0-5	2	Set the 2nd velocity detection filter to one of 6 levels.	B	All	5-2
	09	2nd torque filter time constant	0.01 ms	0-2500	2	Set the time constant of the 2nd torque filter.	B	All	5-2
	10	Velocity feed forward gain	0.1%	0-4000	2	Set the velocity feed forward gain.	B	Position,	5-2-8
	11	Velocity feed forward filter	0.01 ms	0-6400	2	Set the time constant of velocity feed forward filter. *It becomes invalid in two-degree-of-freedom control mode.	B	Position,	5-2-8
	12	Torque feed forward gain	0.1%	0-2000	2	Set the torque feed forward gain.	B	All	5-2-8
	13	Torque feed forward filter	0.01 ms	0-6400	2	Set the torque feed forward filter.	B	All	5-2-8
	14	2nd gain setup	-	0-1	2	Using the gain switching function, set this parameter for the best tuning.	B	All	5-2-4
	15	Mode of position control switching	-	0-10	2	Set the condition of gain switching for position control.	B	Position,	5-2-4
	16	Delay time of position control switching	0.1 ms	0-10000	2	Set the delay time when switching from 2nd to 1st gain.	B	Position,	5-2-4
	17	Level of position control switching	-	0-20000	2	Set the gain switching level.	B	Position,	5-2-4
	18	Hysteresis at position control switching	-	0-20000	2	Set the hysteresis at gain switching.	B	Position,	5-2-4
	19	Position gain switching time	0.1 ms	0-10000	2	Set the position gain switching time upon gain switching.	B	Position,	5-2-4
	20	Mode of velocity control switching	-	0-5	2	Set the condition of gain switching for velocity control	B	Velocity	5-2-4
	21	Delay time of velocity control switching	0.1 ms	0-10000	2	Set the delay time when switching from 2nd to 1st gain.	B	Velocity	5-2-4
	22	Level of velocity control switching	-	0-20000	2	Set the gain switching level.	B	Velocity	5-2-4
	23	Hysteresis at velocity control switching	-	0-20000	2	Set the hysteresis at gain switching.	B	Velocity	5-2-4
	24	Mode of torque control switching	-	0-3	2	Set the condition of gain switching for torque control	B	Torque	5-2-4
	25	Delay time of torque control switching	0.1 ms	0-10000	2	Set the delay time when switching from 2nd to 1st gain.	B	Torque	5-2-4
	26	Level of torque control switching	-	0-20000	2	Set the gain switching level.	B	Torque	5-2-4
27	Hysteresis at torque control switching	-	0-20000	2	Set the hysteresis at gain switching.	B	Torque	5-2-4	

(To be continued)

9-1-3 Class 2: Damping control

Class	No.	Title	Unit	Range	Size [byte]	Function / Contents	Attribute	Related control mode	Reference
2	00	Adaptive filter mode setup	-	0-6	2	Set the operation of adaptive filter.	B	Position, Velocity,	5-1-2
	01	1st notch frequency	Hz	50-5000	2	Set the notch frequency of 1st resonance suppression notch filter. Set the notch frequency to the resonance frequency of the machine.	B	All	5-2-5
	02	1st notch width selection	-	0-20	2	Set the notch width of 1st resonance suppression notch filter.	B	All	5-2-5
	03	1st notch depth selection	-	0-99	2	Set the notch depth of 1st resonance suppression notch filter.	B	All	5-2-5
	04	2nd notch frequency	Hz	50-5000	2	Set the notch frequency of 2nd resonance suppression notch filter. Set the notch frequency to the resonance frequency of the machine.	B	All	5-2-5
	05	2nd notch width selection	-	0-20	2	Set the notch width of 2nd resonance suppression notch filter.	B	All	5-2-5
	06	2nd notch depth selection	-	0-99	2	Set the notch depth of 2nd resonance suppression notch filter.	B	All	5-2-5
	07	3rd notch frequency	Hz	50-5000	2	Set the notch frequency of 3rd resonance suppression notch filter. Set the notch frequency to the resonance frequency of the machine. Automatically set when the adaptive notch is enabled.	B	All	5-1-2 5-2-5
	08	3rd notch width selection	-	0-20	2	Set the notch width of 3rd resonance suppression notch filter. Automatically set when the adaptive notch is enabled.	B	All	5-1-2 5-2-5
	09	3rd notch depth selection	-	0-99	2	Set the notch depth of 3rd resonance suppression notch filter. Automatically set when the adaptive notch is enabled.	B	All	5-1-2 5-2-5
	10	4th notch frequency	Hz	50-5000	2	Set the notch frequency of 4th resonance suppression notch filter. Set the notch frequency to the resonance frequency of the machine. Automatically set when the adaptive notch is enabled.	B	All	5-1-2 5-2-5
	11	4th notch width selection	-	0-20	2	Set the notch width of 4th resonance suppression notch filter. Automatically set when the adaptive notch is enabled.	B	All	5-1-2 5-2-5
	12	4th notch depth selection	-	0-99	2	Set the notch depth of 4th resonance suppression notch filter. Automatically set when the adaptive notch is enabled.	B	All	5-1-2 5-2-5
	13	Selection of damping filter switching	-	0-6	2	Select the filters to be used for damping control.	B	Position,	5-2-6
	14	1st damping frequency	0.1 Hz	0-3000	2	You can set up the 1st damping frequency of the damping control which suppresses vibration at the load edge. Setting value of 5 (= 0.5 Hz) or higher is valid.	B	Position,	5-2-6
	15	1st damping filter setup	0.1 Hz	0-1500	2	Fine tune the 1st filter damping control. Decrease the setting value to avoid torque saturation or increase the value to improve the response.	B	Position,	5-2-6
	16	2nd damping frequency	0.1 Hz	0-3000	2	You can set up the 2nd damping frequency of the damping control which suppresses vibration at the load edge. Setting value of 5 (= 0.5 Hz) or higher is valid.	B	Position,	5-2-6
	17	2nd damping filter setup	0.1 Hz	0-1500	2	Fine tune the 2nd filter damping control. Decrease the setting value to avoid torque saturation or increase the value to improve the response.	B	Position,	5-2-6
	18	3rd damping frequency	0.1 Hz	0-3000	2	You can set up the 3rd damping frequency of the damping control which suppresses vibration at the load edge. Setting value of 5 (= 0.5 Hz) or higher is valid.	B	Position,	5-2-6
	19	3rd damping filter setup	0.1 Hz	0-1500	2	Fine tune the 3rd filter damping control. Decrease the setting value to avoid torque saturation or increase the value to improve the response.	B	Position,	5-2-6
	20	4th damping frequency	0.1 Hz	0-3000	2	You can set up the 4th damping frequency of the damping control which suppresses vibration at the load edge. Setting value of 5 (= 0.5 Hz) or higher is valid.	B	Position,	5-2-6
21	4th damping filter setup	0.1 Hz	0-1500	2	Fine tune the 4th filter damping control. Decrease the setting value to avoid torque saturation or increase the value to improve the response.	B	Position,	5-2-6	

(To be continued)

Class 2: Damping control

Class	No.	Title	Unit	Range	Size [byte]	Function / Contents	Attribute	Related control mode	Reference
2	22	Positional command smoothing filter	0.1 ms	0–10000	2	<p>[For position control]</p> <ul style="list-style-type: none"> For conventional control (Pr 6.47 bit 0 = 0) Will set time constant of primary delay filter against position command. 2 degrees of freedom control (Pr 6.47 bit 0 = 1) Will be set to time constant of command response filter. Maximum value is limited to 2,000 (=200.0 ms) *1 <p>[For velocity control]</p> <ul style="list-style-type: none"> For conventional control (Pr 6.47 bit 0 = 0) This setting will be ignored. 2 degrees of freedom control (Pr 6.47 bit 0 = 1) Will be set to time constant of command response filter. Maximum value is limited to 640 (= 64.0 ms) *1 <p>*1: The value of the parameter itself will not be limited but the value to be applied will be limited within the driver. Attenuation term can be set at Pr 6.49 “Adjust/Torque command attenuation term”.</p>	B	Position, Velocity,	4-2-3 5-2-14 5-2-15
	23	Positional command FIR filter	0.1 ms	0–10000	2	Set the time constant of the FIR filter in response to the positional command.	B	Position,	4-2-3
	24	5th notch frequency	Hz	50–5000	2	Set the notch frequency for the 5th resonance suppression notch filter. Set the notch frequency to the resonance frequency of the machine.	B	All	5-2-5
	25	5th notch width selection	-	0–20	2	Set the notch width for the 5th resonance suppression notch filter.	B	All	5-2-5
	26	5th notch depth selection	-	0–99	2	Set the notch depth for the 5th resonance suppression notch filter.	B	All	5-2-5
	27	1st damping width setting	-	0–1000	2	Fine tune the 1st damping control function.	B	Position,	5-2-6
	28	2nd damping width setting	-	0–1000	2	Fine tune the 2nd damping control function.	B	Position,	5-2-6
	29	3rd damping width setting	-	0–1000	2	Fine tune the 3rd damping control function.	B	Position,	5-2-6
	30	4th damping width setting	-	0–1000	2	Fine tune the 4th damping control function.	B	Position,	5-2-6
	31	For manufacturer's use	-	-	2	Permanently set at 0.	-	-	-
	32	For manufacturer's use	-	-	2	Permanently set at 0.	-	-	-
	33	For manufacturer's use	-	-	2	Permanently set at 0.	-	-	-
	34	For manufacturer's use	-	-	2	Permanently set at 0.	-	-	-
	35	For manufacturer's use	-	-	2	Permanently set at 0.	-	-	-
	36	For manufacturer's use	-	-	2	Permanently set at 0.	-	-	-
	37	For manufacturer's use	-	-	2	Permanently set at 0.	-	-	-

9-1-4 Class 3: Velocity/ Torque/ Scale

Class	No.	Title	Unit	Range	Size [byte]	Function / Contents	Attribute	Related control mode	Reference
3	04	For manufacturer's use	—	—	2	Permanently set at 0.	—	—	—
	05	For manufacturer's use	—	—	2	Permanently set at 0.	—	—	—
	12	Acceleration time setup	ms/ (1000 r/min)	0–10000	2	Set the acceleration processing time in response to the velocity instruction input.	B	Velocity	4-3-3
	13	Deceleration time setup	ms/ (1000 r/min)	0–10000	2	Set the deceleration processing time in response to the velocity instruction input.	B	Velocity	4-3-3
	14	Sigmoid acceleration/ deceleration time setup	ms	0–1000	2	Set the S-curve time for acceleration/deceleration process when the velocity instruction is applied.	B	Velocity	4-3-3
	17	Selection of speed limit	—	—	2	Set the speed limit	B	Torque	4-4-1
	21	For manufacturer's use	—	—	2	Permanently set at 0.	—	—	—
	22	For manufacturer's use	—	—	2	Permanently set at 0.	—	—	—
	23	Feedback scale selection	—	0–6	2	Select the type of feedback scale. 0: A,B phase output type 1: Serial communication type (incremental specification) 2: Serial communication type (absolute specification) 3: For manufacturer's use 4: For manufacturer's use 5: For manufacturer's use 6: Serial communication type (absolute spec.)	R	All	4-6-1 4-7
	24	For manufacturer's use	—	—	4	Permanently set at 0.	—	—	—
	25	For manufacturer's use	—	—	4	Permanently set at 1.	—	—	—
	26	Reversal of direction of feedback scale & CS	—	0–3	2	Set the polarity of feedback scale feedback pulse and the CS signal.	R	All	4-7
	27	Feedback scale Z phase disconnection detection disable	—	0–1	2	Validate/Invalidate Z-phase disconnection detection when using AB phase output type feedback scale. 0: Valid, 1: Invalid	R	All	4-7
	28	For manufacturer's use	—	—	4	Permanently set at 1.	—	—	—
	29	For manufacturer's use	—	—	2	Permanently set at 0.	—	—	—
	33	For manufacturer's use	—	—	4	Permanently set at 0.	—	—	—
	34	For manufacturer's use	—	—	2	Permanently set at 0.	—	—	—
35	For manufacturer's use	—	—	4 *1)	Permanently set at 0.	—	—	—	
36	For manufacturer's use	—	—	4	Permanently set at 0.	—	—	—	

*1) It is not supported in versions corresponding to function extended edition 8 or earlier.

9-1-5 Class 4: I/O monitor setting

Class	No.	Title	Unit	Range	Size [byte]	Function / Contents	Attribute	Related control mode	Reference
4	00	SI1 input selection	—	0– 00FFFFFFh	4	Set function and logic of SI1.	C	All	2-4-1
	01	SI2 input selection	—	0– 00FFFFFFh	4	Set function and logic of SI2.	C	All	2-4-1
	02	SI3 input selection	—	0– 00FFFFFFh	4	Set function and logic of SI3.	C	All	2-4-1
	03	SI4 input selection	—	0– 00FFFFFFh	4	Set function and logic of SI4.	C	All	2-4-1
	04	SI5 input selection	—	0– 00FFFFFFh	4	Set function and logic of SI5.	C	All	2-4-1
	05	SI6 input selection	—	0– 00FFFFFFh	4	Set function and logic of SI6.	C	All	2-4-1
	06	SI7 input selection	—	0– 00FFFFFFh	4	Set function and logic of SI7.	C	All	2-4-1
	07	SI8 input selection	—	0– 00FFFFFFh	4	Set function and logic of SI8.	C	All	2-4-1
	10	SO1 output selection	—	0– 00FFFFFFh	4	Set SO1 function allocation.	C	All	2-4-2
	11	SO2 output selection	—	0– 00FFFFFFh	4	Set SO2 function allocation.	C	All	2-4-2
	12	SO3 output selection	—	0– 00FFFFFFh	4	Set SO3 function allocation. ※Please do not change the shipment value setting with V frame.	C	All	2-4-2
	16	Type of analog monitor 1	—	0–30 *1)	2	Select the type of monitor for analog monitor 1. ※Please do not change the shipment value setting with V frame.	A	All	3-4
	17	Analog monitor 1 output gain	—	0–214748364	4	Set the output gain of analog monitor 1. ※Please do not change the shipment value setting with V frame.	A	All	3-4
	18	Type of analog monitor 2	—	0–30 *1)	2	Select the type of monitor for analog monitor 2. ※Please do not change the shipment value setting with V frame.	A	All	3-4
	19	Analog monitor 2 output gain	—	0–214748364	4	Set the output gain of analog monitor 2. ※Please do not change the shipment value setting with V frame.	A	All	3-4
	21	Analog monitor output setup	—	0–2	2	Select output voltage format of the analog monitor. ※Please do not change the shipment value setting with V frame.	A	All	3-4
	22	For manufacturer's use	—	—	2	Permanently set at 0.	—	—	—
	23	For manufacturer's use	—	—	2	Permanently set at 0.	—	—	—
	24	For manufacturer's use	—	—	2	Permanently set at 0.	—	—	—
	31	Positioning complete (In-position) range	Command unit	0–2097152	4	Set allowable the number of pulses for positioning complete signal (INP). Unit is according to Pr5.20 "Position setup unit select".	A	Position,	4-2-4
	32	Positioning complete (In-position) output setup	-	0–10	2	Set the condition for positioning complete output.	A	Position,	4-2-4
	33	INP hold time	ms	0–30000	2	Set the INP hold time	A	Position,	4-2-4
	34	Zero-speed	r/min	10–20000	2	Set threshold for zero speed (ZSP) detection.	A	All	2-4-2
	35	Speed coincidence range	r/min	10–20000	2	Set the detection threshold of speed coincidence output (V-COIN) by the difference between the velocity command and the actual speed.	A	Velocity, Torque	4-3-2
36	At-speed (Speed arrival)	r/min	10–20000	2	Set the detection timing of the speed arrival output (AT-SPEED).	A	Velocity, Torque	4-3-1	
37	Mechanical brake action at stalling setup	ms	0–10000	2	Set the mechanical brake operating time at stalling.	B	All	9-2-2	
38	Mechanical brake action at running setup	ms	0–32000	2	Set the mechanical brake operating time at running.	B	All	6-3-7 8-3-1 9-2-3 9-2-4 9-2-5	
39	Brake release speed setup	r/min	30–3000	2	Set the speed timing for judgement of mechanical brake output during operation.	B	All	8-3-1 9-2-3 9-2-4 9-2-5	

*1) In the enhanced version 4 and earlier, the setting range is 0 to 28.

(To be continued)

Class	No.	Title	Unit	Range	Size [byte]	Function / Contents	Attribute	Related control mode	Reference
4	40	Selection of alarm output 1	—	0-40	2	Select the type of warning issued as the alarm output 1.	A	All	7-3
	41	Selection of alarm output 2	—	0-40	2	Select the type of warning issued as the alarm output 2.	A	All	7-3
	42	Positioning complete (In-position) range 2	Command unit	0-2097152	4	Set the acceptable number of pulses for positioning complete signal 2 (INP2). Unit is according to Pr5.20 "Position setup unit select".	A	Position,	4-2-4
	44	Position comparison output pulse width setting	0.1ms	0-32767	2	Set the pulse width of the signal that is output for position comparison. The signal is not output when 0 is set.	R	All	6-5
	45	Position comparison output polarity selection	-	0-7	2	Set the polarity of position comparison output by bit setup for each output terminal. • Setup bits bit0: SO1,OCMP1 bit1: SO2,OCMP2 bit2: SO3,OCMP3 • Setup values of each setting bit 0: The output photocoupler is turned ON for SO1 to 3 and is set to L level for OCMP1 to 3, respectively, during pulse output. 1: The output photocoupler is turned OFF for SO1 to 3 and is set to H level for OCMP1 to 3, respectively, during pulse output. Basically, use this function as 0. ※Do not use SO3 with V frame.	R	All	6-5
	47	Pulse output selection	-	0-1	2	Pulse regeneration output/Select the signal to be output from the pulse generation output terminal or Position comparison output terminal. 0: Feedback scale output signal 1: Position comparison output signal	R	All	4-2-5 6-5
	48	Position comparison value 1	Command unit	-2147483648-2147483647	4	Set the comparison value for position comparison output 1.	A	All	6-5
	49	Position comparison value 2	Command unit	-2147483648-2147483647	4	Set the comparison value for position comparison output 2.	A	All	6-5
	50	Position comparison value 3	Command unit	-2147483648-2147483647	4	Set the comparison value for position comparison output 3.	A	All	6-5
	51	Position comparison value 4	Command unit	-2147483648-2147483647	4	Set the comparison value for position comparison output 4.	A	All	6-5
	52	Position comparison value 5	Command unit	-2147483648-2147483647	4	Set the comparison value for position comparison output 5.	A	All	6-5
	53	Position comparison value 6	Command unit	-2147483648-2147483647	4	Set the comparison value for position comparison output 6.	A	All	6-5
	54	Position comparison value 7	Command unit	-2147483648-2147483647	4	Set the comparison value for position comparison output 7.	A	All	6-5
	55	Position comparison value 8	Command unit	-2147483648-2147483647	4	Set the comparison value for position comparison output 8.	A	All	6-5
56	Position comparison output delay compensation amount	0.1us	-32768-32767	2	Compensate the delay in the position comparison output signaled by the circuit.	R	All	6-5	

(To be continued)

Class	No.	Title	Unit	Range	Size [byte]	Function / Contents	Attribute	Related control mode	Reference
4	57	Position comparison output assignment setting	-	-2147483648- 2147483647	4	<p>Set the output terminals corresponding to position comparison values 1 to 8 by bit setup. Multiple position comparison values can be set up on one output terminal.</p> <ul style="list-style-type: none"> • Setup bits <ul style="list-style-type: none"> bit0 to 3 : Position comparison output 1 bit4 to 7 : Position comparison output 2 bit8 to 11: Position comparison output 3 bit12 to 15 : Position comparison output 4 bit16 to 19 : Position comparison output 5 bit20 to 23: Position comparison output 6 bit24 to 27: Position comparison output 7 bit28 to 31 : Position comparison output 8 • Setup values of each setting bit <ul style="list-style-type: none"> 0000b : Output disabled 0001b : Assigned to SO1,OCMP1 0010b : Assigned to SO2,OCMP2 0011b : Assigned to SO3,OCMP3 <p>Other than above: For manufacturer's use (Do not set.) ※Do not use SO3 with V frame.</p>	R	All	6-5

9-1-6 Class 5: Enhancing setting

Class	No.	Title	Unit	Range	Size [byte]	Function / Contents	Attribute	Related control mode	Reference
5	03	Denominator of pulse output division	—	0–8388608	4	Set up the denominator of pulse output division.	R	All	4-2-5
	04	Over-travel inhibit input setup	—	0–2	2	Set the operation of the inhibit positive/ negative direction travel inputs.	C	All	6-3-1 7-4 7-5
	05	Sequence at over-travel inhibit	—	0–2	2	Set the sequence when over-travel inhibit is input.	C	All	6-3-1 7-4
	06	Sequence at Servo-Off	—	0–9	2	Set the sequence while servo is OFF.	B	All	6-3-2
	07	Sequence upon main power off	—	0–9	2	Set the sequence while main AC power is OFF. ※Please do not change the shipment value setting with V frame.	B	All	6-3-3
	08	L/V trip selection upon main power off	—	0–3	2	Select L/V trip or servo OFF upon occurrence of main AC power alarm. Setup the condition to detect main AC power OFF alarm when the main AC power is kept interrupted for a time longer than the time set by Pr7.14. bit0 0: The servo off according to the setting of 6007h(Abort connection option code) or Pr5.07. 1: Trip with Err 13.1 Main power undervoltage protection. bit 1 0: Detect main AC power OFF alarm only when servo is in ON state. 1: Always detect main AC power OFF alarm. ※Please do not change the shipment value setting with V frame.	B	All	6-3-3
	09	Detection time of main power off	1 ms	20–2000 *1)	2	Set the main AC power alarm detection time. Main AC power OFF detection is disabled when the setting value is 2000. ※Please do not change the shipment value setting with V frame.	C	All	6-3-3
	10	Sequence at alarm	—	0–7	2	Set the sequence used upon occurrence of an alarm.	B	All	6-3-4 6-3-5 6-3-6
	11	Torque setup for emergency stop	%	0–500	2	Set up the torque limit at emergency stop. When setup value is 0, the torque limit for normal operation is applied.	B	All	6-3-1 6-3-2 6-3-3 6-3-5
	12	Over-load level setup	%	0–500	2	You can set up the over-load level. It becomes 115% by setting up this to 0. The setup value of this parameter is limited by 115% of the motor rating.	A	All	—
	13	Over-speed level setup	r/min	0–20000	2	If the motor speed exceeds this setup value, Err26.0 Over-speed protection occurs. If setup value is 0, Err 26.0 will be activated with a setup value for Pr 9.10 "Maximum over-speed level". Err26.0 occurs at the setting value in Pr9.10 if this setting value exceeds the value in Pr9.10. (The parameter value is not restricted.)	B	All	6-3-5 7-4
	14	Motor working range setup	0.1 Magnet pole pitch	0–1000	2	You can set up the movable range of the motor against the position command input range. When the motor movement exceeds the setup value, Err34.0 "software limit protection" will be triggered. When set value of this parameter is 0, Err34.0 become disable. Also in conditions written in section 6-2 (2) Caution, Err34.0 become disable.	A	Position,	6-2 7-4
	15	Control input signal reading setup	—	0–3	2	Set up a read signal for cycle of the control input. 0:0.250ms,1:0.500ms,2:1.000ms,3:2.000ms However, the following are exceptions. - When using POT/NOT/HOME as the home position reference trigger - The external latch input1/2(EXT1/2) (Note) Read cycle differs from MINAS-A5BL series.	C	All	—

*1) To use this setting with different value from shipment value , please check matching with your power supply environment.

(To be continued)

Class	No.	Title	Unit	Range	Size [byte]	Function / Contents	Attribute	Related control mode	Reference
5	16	For manufacturer's use	—	—	2	Permanently set at 1.	—	—	—
	20	Position setup unit select	—	0-1	2	Specify the unit to determine the range of positioning complete and excessive positional deviation. 0: Command unit, 1: Feedback scale unit Note: Positioning complete(6041h bit10(Target reached)) detection threshold of EtherCAT communication status is always command unit regardless of the setting of this parameter.	C	Position,	4-2-4 7-4
	21	Selection of torque limit	—	0-5 *1)	2	Select positive direction or negative direction torque limit. When 0 is set, 1 will be internally set. Only the setting Pr5.21=5 becomes enabled during torque control. When Pr5.21=1 to 4, Pr0.13 is applied to the torque limit.	B	All	6-1
	22	2nd torque limit	%	0-500	2	You can set up the 2nd limit value of the motor output torque. Note that the maximum torque limit for the motor applied can be calculated according to the expression given below. Maximum torque limit [%] = 100 x Pr9.07/(Pr9.06 x $\sqrt{2}$)	B	Position, Velocity	6-1
	25	For manufacturer's use	—	—	2	Permanently set at 0.	—	—	—
	26	For manufacturer's use	—	—	2	Permanently set at 0.	—	—	—
	29	For manufacturer's use	—	—	2	Permanently set at 2.	—	—	—
	31	USB axis address	—	0-127	2	Set up the axis number for USB communication.	R	All	—
	33	Pulse regenerative output limit setup	—	0-1	2	Enable/disable detection of Err 28.0 "Pulse regenerative limit protection". 0: Invalid 1: Valid	C	All	4-2-5
	34	For manufacturer's use	—	—	2	Permanently set at 4.	—	—	—
	36	For manufacturer's use	—	—	2	Permanently set at 0.	—	—	—
	45	Quadrant glitch positive-direction compensation value	0.1%	-1000-1000	2	Set the positive-direction high-precision torque compensation value for quadrant glitches.	B	Position,	5-2-13
	46	Quadrant glitch negative-direction compensation value	0.1%	-1000-1000	2	Set the negative-direction high-precision torque compensation value for quadrant glitches.	B	Position,	5-2-13
	47	Quadrant glitch compensation delay time	ms	0-1000	2	Set the compensation timing delay time for quadrant glitches.	B	Position,	5-2-13
	48	Quadrant glitch compensation filter setting L	0.01 ms	0-6400	2	Set the compensation value LPF time constant for quadrant glitches.	B	Position,	5-2-13
	49	Quadrant glitch compensation filter setting H	0.1 ms	0-10000	2	Set the compensation value HPF time constant for quadrant glitches.	B	Position,	5-2-13
	50	For manufacturer's use	—	—	4	Permanently set at 0.	—	—	—
	51	For manufacturer's use	—	—	4	Permanently set at 0.	—	—	—
	52	For manufacturer's use	—	—	4	Permanently set at 0.	—	—	—
	53	For manufacturer's use	—	—	4	Permanently set at 0.	—	—	—
54	For manufacturer's use	—	—	4	Permanently set at 0.	—	—	—	
55	For manufacturer's use	—	—	4	Permanently set at 0.	—	—	—	

*1) The setting range is 0 to 4 in function extended version 2 and earlier versions.
(To be continued)

Class	No	Title	Unit	Range	Size [byte]	Function / Contents	Attribute	Related control mode	Reference
5	56	Slow stop deceleration time setting	ms/ (1000 r/min)	0 – 10000	2	Sets deceleration time for slow stop deceleration processing. This parameter will become valid when Pr6.10 “Function expansion setup” bit 15 = 1	B	All	6-3-7
	57	Slow stop S-shape acceleration and deceleration setting	ms	0 – 1000	2	Sets the S-shape time for slow stop deceleration processing. This parameter will become valid when Pr6.10 “Function expansion setup” bit 15 = 1	B	All	6-3-7
	66	Deterioration diagnosis convergence judgment time	0.1s	0 – 10000	2	Sets time for deemed convergence of real-time auto tuning load characteristics estimate when deterioration diagnosis warning function is valid (Pr6.97 bit 1 = 1) When the set value is 0, it will be set automatically inside the driver in accordance with Pr6.31 “Real time auto tuning estimation speed”. * When Pr6.31 “Real time auto tuning estimation speed” = 0, the deterioration diagnosis warning judgment for load characteristics estimate will be invalid.	A	All	6-6
	67	Deterioration diagnosis inertia ratio upper limit	%	0 – 10000	2	Sets the upper and lower limit values for inertia ratio estimate in deterioration diagnosis judgment of load characteristics estimate after completion of convergence, when deterioration diagnosis warning is valid (Pr6.97 bit 1 = 1). * When the upper limit value is set at 10000 (max. value), judgment of the upper limit becomes invalid.	A	All	6-6
	68	Deterioration diagnosis inertia ratio lower limit	%	0– 10000	2	* When the lower limit value is set at 0 (min. value), judgment of the lower limit becomes invalid. * If Pr5.67 (upper limit) ≤ Pr5.68 (lower limit), judgment of both the upper limit and lower limit becomes invalid. * The set resolution shall be in units of 0.2%.	A	All	6-6
	69	Deterioration diagnosis unbalanced load upper limit	0.1%	-1000– 1000	2	Sets the upper and lower limit values for unbalanced load estimate in deterioration diagnosis judgment of load characteristics estimate after completion of convergence, when deterioration diagnosis warning is valid (Pr6.97 bit 1 = 1). * When the upper limit value is set at 1000 (max. value), judgment of the upper limit becomes invalid.	A	All	6-6
	70	Deterioration diagnosis unbalanced load lower limit	0.1%	-1000– 1000	2	* When the lower limit value is set at -1000 (min. value), judgment of the lower limit becomes invalid. * If Pr5.69 (upper limit) ≤ Pr5.70 (lower limit), judgment of both the upper limit and lower limit becomes invalid. * The set resolution shall be in units of 0.2%.	A	All	6-6
	71	Deterioration diagnosis dynamic friction upper limit	0.1%	-1000– 1000	2	Sets the upper and lower limit values for dynamic friction estimate in deterioration diagnosis judgment of load characteristics estimate after completion of convergence, when deterioration diagnosis warning is valid (Pr6.97 bit 1 = 1). * When the upper limit value is set at 1000 (max. value), judgment of the upper limit becomes invalid.	A	All	6-6
72	Deterioration diagnosis dynamic friction lower limit	0.1%	-1000– 1000	2	* When the lower limit value is set at -1000 (min. value), judgment of the lower limit becomes invalid. * If Pr5.71 (upper limit) ≤ Pr5.72 (lower limit), judgment of both the upper limit and lower limit becomes invalid. * The set resolution shall be in units of 0.2%.	A	All	6-6	

(To be continued)

Class	No	Title	Unit	Range	Size [byte]	Function / Contents	Attribute	Related control mode	Reference
5	73	Deterioration diagnosis viscous friction upper limit	0.1%/(10000 r/min)	0-10000	2	Sets the upper and lower limit values for viscous friction coefficient estimate in deterioration diagnosis judgment of load characteristics estimate after completion of convergence, when deterioration diagnosis warning is valid (Pr6.97 bit 1 = 1). * When the upper limit value is set at 10000 (max. value), judgment of the upper limit becomes invalid. * When the lower limit value is set at 0 (min. value), judgment of the lower limit becomes invalid. * If Pr5.73 (upper limit) \leq Pr5.74 (lower limit), judgment of both the upper limit and lower limit becomes invalid. * The set resolution shall be in units of 0.2%.	A	All	6-6
	74	Deterioration diagnosis viscous friction lower limit	0.1%/(10000 r/min)	0-10000	2	Same as Pr5.73.	A	All	6-6
	75	Deterioration diagnosis velocity setting	r/min	-20000-20000	2	Outputs deterioration diagnosis velocity output (V-DIAG) when the motor velocity is in the range of Pr5.75 \pm Pr4.35 (velocity coinciding width), when deterioration diagnosis warning is valid (Pr6.97 bit 1 = 1) * Deterioration diagnosis velocity output has a 10 [r/min] hysteresis.	A	All	6-6
	76	Deterioration diagnosis torque average time	ms	0-10000	2	Sets time required to compute the torque command average (weighted frequency) when deterioration diagnosis warning is valid (Pr6.97 bit 1 = 1) and diagnosis velocity output (V-DIAG) is ON. * Time from diagnosis velocity output (V-DIAG) ON to the start judgment for upper and lower value of torque command average value is also a part of the set time for this parameter. * If the setting value is 0, the torque command average value is not calculated.	A	All	6-6
	77	Deterioration diagnosis torque upper limit	0.1%	-1000-1000	2	Sets the upper and lower limit values for torque command average value when deterioration diagnosis warning is valid (Pr6.97 bit 1 = 1) and deterioration diagnosis velocity output (V-DIAG) is ON * When the upper limit value is set at 1000 (max. value), judgment of the upper limit becomes invalid. * When the lower limit value is set at -1000 (min. value), judgment of the lower limit becomes invalid. * If Pr5.77 (upper limit) \leq Pr5.78 (lower limit), judgment of both the upper limit and lower limit becomes invalid.	A	All	6-6
	78	Deterioration diagnosis torque lower limit	0.1%	-1000-1000	2	Same as Pr5.77.	A	All	6-6
	94*1)	Position comparison Output condition setting	-	0~2	2	Selects the operation direction in which position comparison output is enabled. 0: Enabled in positive and negative directions 1: Enabled only for positive direction operation 2: Enabled only for negative direction operation	A	All	6-5
	96	For manufacturer's use	—	—	2	Please do not change the shipment value.	—	—	—
	97	For manufacturer's use	—	—	2	Please do not change the shipment value.	—	—	—

*1) It is not supported in versions corresponding to function extended edition 8 or earlier.

9-1-7 Class 6: Special setting

Class	No.	Title	Unit	Range	Size [byte]	Function / Contents	Attribute	Related control mode	Reference
6	02	Speed deviation excess setup	r/min	0-20000	2	Set threshold of Err 24.1 Speed over deviation protection. This protection is not detected when the setup value is 0.	A	Position	—
	03 *1)	For manufacturer's use	-	-	2	Permanently set at 0.	—	—	—
	05	Position 3rd gain valid time	0.1 ms	0-10000	2	Set up 3rd gain valid time of 3 gain level adjustment.	B	Position,	5-2-10
	06	Position 3rd gain scale factor	%	50-1000	2	Set up the 3rd gain by a multiplying factor of the 1st gain	B	Position,	5-2-10
	07	Torque command additional value	%	-100-100	2	Set up the offset torque to be added to the torque command.	B	Position, Velocity	5-2-11
	08	Positive direction torque compensation value	%	-100-100	2	Set up the value to be added to the torque command for positive direction operation.	B	Position,	5-2-11
	09	Negative direction torque compensation value	%	-100-100	2	Set up the value to be added to the torque command for negative direction operation.	B	Position,	5-2-11
	10	Function expansion setup	—	-32768-32768	2	Set up the function in unit of bit. bit0 unused. Always set to 0. bit1 Load variation suppression function 0:Invalid 1:Valid bit2 Load variation stabilization setting 0:Invalid 1:Valid. bit3 For manufacturer's use. Always set to 0. bit4 Current response improvement 0:Invalid 1: Valid bit5 For manufacturer's use. Always set to 0. bit6-8 unused. Always set to 0. bit9 For manufacturer's use. Always set to 1. bit10 Fall prevention function in case of alarms 0:Invalid 1: Valid bit11 For manufacturer's use. Always set to 0. bit12 unused. Always set to 0. bit13 For manufacturer's use. Always set to 0. bit14 Load variation suppression function automatic setting 0: Invalid 1: Valid *1 bit15 Slow stop function 0: Invalid 1: Valid *bit 0 is the least significant bit. *1 When bit14 to 1, it will be bit1 and 2 also 1.	B	All	5-1-1 5-1-3 5-1-4 5-2-10 6-3-6 6-3-7
	11	For manufacturer's use.	—	—	2	Always set to 100.	—	—	—
	14	Emergency stop time at alarm	ms	0-1000	2	Set up the time allowed to complete emergency stop in an alarm condition.	B	All	6-3-5 6-3-7 9-2-5
	15	2nd over-speed level setup	r/min	0-20000	2	When the motor speed exceeds this setup time during emergency stop sequence in an alarm condition, Err 26.1 2nd over-speed protection will be activated. If setup value is 0, Err 26.1 will be activated with a setup value for Pr 9.10 "Maximum over-speed level". Err26.1 occurs at the setting value in Pr9.10 if this setting value exceeds the value in Pr9.10. (The parameter value is not restricted.)	B	All	6-3-5

*1) It is not supported in versions corresponding to function extended edition 8 or earlier.
(To be continued)

Class	No.	Title	Unit	Range	Size [byte]	Function / Contents	Attribute	Related control mode	Reference
6	18	Power-up wait time	0.1 s	0-100	2	Set up the standard initialization time approx. $1.5 s + \alpha(\text{setting value} \times 0.1s)$ after power-up. For example, in the case of the preset value 10, it is set to $1.5s + (10 \times 0.1 s) = \text{approx. } 2.5s$. * If the period until LINK establishment is too long, it may be possible to improve this phenomenon by setting different values in the Pr6.18 for adjacent amplifiers (such as 0.0 s and 0.1 s).	R	All	9-2-1
	19	For manufacturer's use	—	—	2	Permanently set at 0.	—	—	—
	20	For manufacturer's use	—	—	2	Permanently set at 0.	—	—	—
	21	For manufacturer's use	—	—	4	Permanently set at 0.	—	—	—
	22	AB phase feedback scale pulse output method selection	—	0-1	2	Select regeneration method of OA and OB pulse output when using AB phase output type external feedback scale. 0: Signal is not regenerated 1: Signal is regenerated • When signal regeneration is selected, the driver reproduces duty of OA and OB, minimizing waveform distortion.	R	Position,	4-2-5
	23	Load change compensation gain	%	-100-100	2	Set the compensation gain for a load change.	B	Position, Velocity,	5-2-10
	24	Load change compensation filter	0.01 ms	10-2500	2	Set the filter time constant for a load change.	B	Position, Velocity,	5-2-10
	25	For manufacturer's use	—	—	2	Please do not change the shipment value.	—	—	—
	26	For manufacturer's use	—	—	4	Please do not change the shipment value.	—	—	—
	27	Warning latch state setup	—	0-3	2	Determine whether to latch warning state. General warning and Extended warning can be specified. bit 0 Extended warning 0: unlatched 1: latched bit 1 General warning 0: unlatched 1: latched	C	All	7-3
	30	For manufacturer's use	—	—	2	Permanently set at 0.	—	—	—
	31	Real time auto tuning estimation speed	—	0-3	2	Set up the load characteristics estimation speed with the real time auto tuning being valid.	B	All	5-1-1 5-1-3 5-1-4
	32	Real time auto tuning custom setup	—	-32768-32767	2	Set up details of real time auto tuning customize mode.	B	All	5-1-1 5-1-3 5-1-4
	34	For manufacturer's use	—	—	—	Permanently set at 0.	—	—	—
	35	For manufacturer's use	—	—	—	Permanently set at 0.	—	—	—
	36	Dynamic brake operation input setup	-	0-1	2	Set enable or disable dynamic brake (DB) operation input by I/O. 0: Disabled 1: Enabled (Note) This function is available only when the main power is turned off.	R	All	6-3-3
	37	Oscillation detecting level	0.1%	0-1000	2	Set up the oscillation detecting level. Upon detection of a torque vibration whose level is higher than this setup value, the oscillation detection alarm will be issued. If set to 0, oscillation detection warning is disabled.	B	All	7-3
	38	Alarm mask setup	—	-32768-32767	2	Set up the alarm detection mask. Placing 1 to the corresponding bit position disables detection of the alarm condition.	R	All	7-3
	39	Alarm mask setup2	-	-32768-32767	2		C	All	7-3
	41	1st damping depth	—	0-1000	2	Specifies the damping depth of the 1st damping function.	B	Position,	5-2-6
	42	2-stage torque filter time constant	0.01 ms	0-2500	2	Specifies the filter time constant for the torque command. The filter is disabled if the setting value is 0. This setting remains valid irrespective of gain selection state.	B	All	5-2-12
	43	2-stage torque filter attenuation term	—	0-1000	2	Specifies the attenuation term of the 2-stage torque filter.	B	All	5-2-12

(To be continued)

Class	No.	Title	Unit	Range	Size [byte]	Function / Contents	Attribute	Related control mode	Reference
6	47	Function expansion setup2	—	-32768 - 32767	2	Set respective functions in unit of bit. bit0 2 degrees of freedom control mode 0:Invalid 1: Valid bit1-3 For manufacturer's use Permanently set at 0. bit4-7 Not used Permanently set at 0. bit8 For manufacturer's use Permanently set at 0. bit9-11 Not used Permanently set at 0. bit12-13 For manufacturer's use Permanently set at 0. bit14 Quadrant glitch inhibit function 0: Invalid 1: Valid bit15 Not used Permanently set at 0. * The least significant bit is bit0. * Bit3 can be used only when bit0 is set to 1 For details on the types, see 5-1-3 "Real-time auto tuning (Two-degrees-of-freedom control mode, standard type)" and 5-1-4 "Real-time auto tuning (Two-degrees-of-freedom control mode, sync type)".	R	All	5-2-13 5-2-14 5-2-15 5-2-16
	48	Tuning filter	0.1ms	0-2000	2	Set the time constant for the tuning filter in 2 degrees of freedom control.	B	Position, Velocity,	5-2-14 5-2-15
	49	Command / tuning filter damping	—	0-99	2	Set the attenuation term for the command filter and tuning filter in 2 degrees of freedom control. A decimal number indication is used. The first digit sets the command filter and the second digit sets the tuning filter. Target digit 0 to 4: No attenuation term, ζ (operated as primary filter) 5 to 9: Secondary filter (Attenuation terms will be 1.0, 0.86, 0.71, 0.50, and 0.35 in order.) Example) To set the command filter to $\zeta=1.0$ and tuning filter 1 to $\zeta=0.71$, the setting value should be 75 (first digit=5 ($\zeta=1.0$), second digit=7 ($\zeta=0.71$)). For the time constant of the command filter, Pr2.22 "Positional command smoothing filter" will be applied.	B	Position,	5-2-14

(To be continued)

Class	No.	Title	Unit	Range	Size [byte]	Function / Contents	Attribute	Related control mode	Reference
6	50	Viscous friction compensating gain	0.1%/(10000r/min)	0-10000	2	The command velocity is multiplied by this setting value, which becomes a correction amount added to the torque command. The unit is [rated torque 0.1%/(10000 r/min)].	B	Position, Velocity,	5-2-14 5-2-15
	51	Wait time for emergency stop	ms	0-10000	2	Set the time to maintain the motor energization after the brake release output (BRK-OFF) is turned OFF in the event of an alarm requiring emergency stop. * Enabled even when Pr6.10 "Function expansion setup" is set to a value other than bit10=1.	B	All	6-3-6
	52	For manufacturer's use	-	-	2	Permanently set at 0.	-	-	-
	53	For manufacturer's use	-	-	2	Permanently set at 0.	-	-	-
	54	For manufacturer's use	-	-	2	Permanently set at 0.	-	-	-
	57	Torque saturation error protection detection time	ms	0-5000	2	Set the torque saturation error protection detection time. If torque saturation continues for the set time or more, Err16.1 "torque saturation error protection" occurs. When 0 is set, the value set for Pr7.16 is enabled.	B	Position, Velocity,	6-4
	58	For manufacturer's use	-	-	4	Permanently set at 0.	-	-	-
	59	For manufacturer's use	-	-	2	Permanently set at 0.	-	-	-
	60	2nd damping depth	-	0-1000	2	Set the damping depth for the 2nd damping function.	B	Position,	5-2-6
	61	1st resonance frequency	0.1Hz	0-3000	2	Set the resonance frequency of the load for the 1st model type damping filter.	B	Position	5-2-7
	62	1st resonance attenuation ratio	-	0-1000	2	Set the resonance attenuation ratio of the load for the 1st model type damping filter.	B	Position	5-2-7
	63	1st anti-resonance frequency	0.1Hz	0-3000	2	Set the anti-resonance frequency of the load for the 1st model type damping filter.	B	Position	5-2-7
	64	1st anti-resonance attenuation ratio	-	0-1000	2	Set the anti-resonance attenuation ratio of the load for the 1st model type damping filter.	B	Position	5-2-7
	65	1st response frequency	0.1Hz	0-3000	2	Set the response frequency of the load for the 1st model type damping filter.	B	Position	5-2-7
	66	2nd resonance frequency	0.1Hz	0-3000	2	Set the resonance frequency of the load for the 2nd model type damping filter.	B	Position	5-2-7
	67	2nd resonance attenuation ratio	-	0-1000	2	Set the resonance attenuation ratio of the load for the 2nd model type damping filter.	B	Position	5-2-7
	68	2nd anti-resonance frequency	0.1Hz	0-3000	2	Set the anti-resonance frequency of the load for the 2nd model type damping filter.	B	Position	5-2-7
	69	2nd anti-resonance attenuation ratio	-	0-1000	2	Set the anti-resonance attenuation ratio of the load for the 2nd model type damping filter.	B	Position	5-2-7
	70	2nd response frequency	0.1Hz	0-3000	2	Set the response frequency of the load for the 2nd model type damping filter.	B	Position	5-2-7
	71	3rd damping depth	-	0-1000	2	Set the damping depth for the 3rd damping function.	B	Position,	5-2-6
	72	4th damping depth	-	0-1000	2	Set the damping depth for the 4th damping function.	B	Position,	5-2-6
	73	Load estimation filter	0.01 ms	0-2500	2	Set the filter time constant for load estimation.	B	Position, Velocity,	5-2-9
	74	Torque compensation frequency 1	0.1 Hz	0-5000	2	Set the filter frequency 1 for speed control output.	B	Position, Velocity,	5-2-9
75	Torque compensation frequency 2	0.1 Hz	0-5000	2	Set the filter frequency 2 for speed control output.	B	Position, Velocity,	5-2-9	
76	Load estimation count	—	0-8	2	Set the number of times regarding load estimation.	B	Position, Velocity,	5-2-9	
85	Retracting operation condition setting	-	-32768-32767	2	Select retracting operation activation and stop determination conditions.	C	All	6-7	
86	Retracting operation alarm setting	-	0-7	2	Set retracting operation alarm clear attributes.	C	All	6-7	
87	For manufacturer's use	-	-	4	Permanently set at 0.	-	-	-	

(To be continued)

Class	No.	Title	Unit	Range	Size [byte]	Function / Contents	Attribute	Related control mode	Reference
6	88	For manufacturer's use	—	—	—	Permanently set at 0.	—	—	—
	95	Over-load warning detection level	%	0-114	2	Sets the threshold value for detecting the warning as the overload factor increases. Sets with the overload factor. If 0 is set, overload warning detection is performed under conventional conditions (85% of overload protection level). In addition, if other than "Pr6.96 ≤ Pr6.95 < (Overload level)" is set, overload warning detection is performed under conventional conditions (85% of overload level).	A	All	7-3
	96	Over-load warning release level	%	0-114	2	Sets the threshold value for releasing the warning when the load factor decreases from the state when the overload warning is occurring. Sets with the overload factor. If 0 is set, overload warning detection is performed under conventional conditions (85% of overload protection level). In addition, if other than "Pr6.96 ≤ Pr6.95 < (Overload level)" is set, overload warning detection is performed under conventional conditions (85% of overload protection level).	A	All	7-3
	97	Function expansion setup 3	-	- 2147483648 - 2147483647	4	Set various functions on a bit basis. bit0: Enables/Disables quadrant projection compensation function extended. 0: Disabled, 1: Enabled * To set the compensation amount of quadrant projection by inversion direction when the direction of the velocity has changed, set Pr6.97 bit0 to 1. bit1: Deterioration diagnosis warning function: 0: Disabled, 1: Enabled bit2: Expansion of Allowable motor operating range abnormal protection: 0: Disabled, 1: Enabled bit7: For manufacture use. Permanently set at 0. bit8: Extension of the subject control mode for 607Fh (Max profile velocity). *1) 0 : standard specifications (pp,hm,ip,pv) 1 : expansion specification (pp,hm,ip,pv,tq,cst) bit9-11 : For manufacture use. Permanently set at 0 bit12: Velocity limit priority function during torque control *2) 0: Torque command priority 1: Velocity limit priority bit13: Toggle output of the Touch Probe latch completion state *2) 0: Disabled, 1: Enabled bit14: Over-travel inhibition warning *3) 0: Invalid, 1: valid bit15-31 : For manufacture use. Permanently set at 0. *bit 0 is the least significant bit.	B	All	4-4-1 5-2-13 6-2 6-6 7-3

*1) The first edition of the software version (Ver1.04) does not support it.

*2) It is not supported in versions corresponding to function extended edition 4 or earlier.

*3) It is not supported in versions corresponding to function extended edition 5 or earlier.

(To be continued)

Class	No.	Title	Unit	Range	Size [byte]	Function / Contents	Attribute	Related control mode	Reference
6	98	Function expansion setup 4	-	- 2147483648 - 2147483647	4	Sets various function in bit units: bit 0 to 7: For manufacture use. Permanently set at 0. bit8: Control mode switching function expansion 0: Conventional specification 1: hm operation expansion specification bit9: For manufacture use. Permanently set at 0. bit10 to 20 : For manufacture use. Please set fixed to 0 bit21 : Extension of conditions for releasing over-travel inhibition *3) 0 : Conventional specification 1 : Expansion specification bit22-31 : For manufacture use. Please set fixed to 0 *bit 0 is the least significant bit.	R	All	-
	100 *1)	For manufacturer's use	—	—	2	Permanently set at 4000.	—	—	—
	101 *1)	For manufacturer's use	—	—	2	Permanently set at 0.	—	—	—
	102 *2)	Setting of over-travel inhibition release level	Command unit	0 - 2147483647	4	Sets the absolute value of the position deviation amount to release the over-travel inhibition state. If the position deviation amount is greater than the set value, the over-travel inhibition state will not be released. When Pr5.04 "Over-travel inhibition input setting" ≠ 1, set Pr6.102 to 0.	B	Csp	6-3-1

*1) It is not supported in versions corresponding to function extended edition 1 or earlier.

*2) It is not supported in versions corresponding to function extended edition 3 or earlier.

9-1-8 Class 7: Special setting 2

Class	No.	Title	Unit	Range	Size [byte]	Function / Contents	Attribute	Related control mode	Reference
7	00	Display on LED	—	0–32767	2	Select type of data displayed on front panel 7-seg LED. ※Please do not change the shipment value setting with V frame.	A	All	3-2
	01	Display time setup upon power-up	100 ms	0–1000	2	Sets node address display time at turning on of control power. When the setting value is 0 to 6, it is processed in 600ms. ※Please do not change the shipment value setting with V frame.	R	All	3-2
	03	Output setup during torque limit	—	0–1	2	Set up judgment condition of output while torque is limited by torque control. 0: Turn ON at torque limit including torque command value 1: Turn ON at torque limit excluding torque command value	A	Torque	—
	04	For manufacturer's use	—	—	2	Permanently set at 0.	—	—	—
	05	For manufacturer's use	—	—	2	Permanently set at 0.	—	—	—
	06	For manufacturer's use	—	—	2	Permanently set at 0.	—	—	—
	07	For manufacturer's use	—	—	2	Permanently set at 0.	—	—	—
	08	For manufacturer's use	—	—	2	Permanently set at 0.	—	—	—
	09	Correction time of latch delay 1	25ns	-2000–2000	2	Set the correction time for delay of the latch trigger signal detection. This parameter can be switched by Pr7.24 bit5. bit5 is 0: The correction time is reflected in both the latch signal rising edge detection and the latch signal falling edge detection. bit5 is 1: The correction time is reflected in the latch signal rising edge detection. *Signal state of edge detection means the following The rising edge detection means the photocoupler is turned ON. The falling edge detection means the photocoupler is turned OFF.	B	All	EtherCAT Spec.
	10	For manufacturer's use	—	—	2	Permanently set at 3.	—	—	—
	11	For manufacturer's use	—	—	4	Permanently set at 0.	—	—	—
	12	For manufacturer's use	—	—	4	Permanently set at 0.	—	—	—
	13	For manufacturer's use	—	—	4	Permanently set at 0.	—	—	—
	14	Main power off warning detection time	ms	0–2000	2	When a main power supply interception state continues, time until it detects main power supply OFF warning is set up. 0–9, 2000: Warning detection is disabled. 10–1999: Unit is [1 ms] Note: Set this parameter so that Pr.7.14 becomes smaller than Pr.5.09 in order for the warning detection is performed before shut-down detection. If the voltage between P and N of the main power converter is decreased to below a specified value before the warning is detected because the setting value is long, the main power low voltage error (Err13.0) occurs before the warning. ※Please do not change the shipment value setting with V frame.	C	All	7-3
	15	For manufacturer's use	—	—	4	Permanently set at 0.	—	—	—

(To be continued)

Class	No.	Title	Unit	Range	Size [byte]	Function / Contents	Attribute	Related control mode	Reference
7	16	Torque saturation error protection frequency	time	0-30000	2	If torque saturated is continued during a preset frequency, Err 16.1 "Torque saturation protection" will be activated. The number of times is counted up every 0.25 ms. For example, when 30000 is set, Err16.1 occurs if the torque saturation condition continues for 7.5 seconds. The count is cleared when the torque saturation condition is removed. When the value set for Pr6.57 is other than 0, the value set for Pr6.57 is enabled.	B	Position, Velocity	6-4
	18	For manufacturer's use	—	—	4	Permanently set at 0.	—	—	—
	22	Communication function extended setup 1	—	-32768 -32767	2	bit 0-4: For manufacturer's use All bits permanently set at 0. bit 5: 6080h(Max motor speed) on csp mode (Amount of change saturation function of command position) 0: Invalid on csp 1: Valid on csp bit 6: Homing return speed limit function enabled 0: Invalid 1: Valid bit 7: In Z phase homing Over-travel inhibit input setup 0: Invalid 1: Valid bit 8-10: For manufacturer's use All bits permanently set at 0. bit 11 : LINK establishment mode selection 0 : mode0 1 : mode1 If link establishing is late, it might be improved by changing the setting. bit 12-15: For manufacturer's use All bits permanently set at 0. *Set up the properly according to the specifications of the host controller. If the setting is not proper, the operation is not be guaranteed.	R	All	3-3 7-5
	23	Communication function extended setup 2	—	-32768 -32767	2	bit0-13: For manufacturer's use All bits permanently set at 0. bit14 : Command positional deviation [Command unit] output setting 0: Internal command position (after filter) [Command unit] - Actual position [command unit] 1: Internal command position (before filter) [Command unit] - Actual position [Command unit]	B	All	3-4

(To be continued)

Class	No.	Title	Unit	Range	Size [byte]	Function / Contents	Attribute	Related control mode	Reference
7	24	Communication function extended setup 3	—	-32768 -32767	2	<p>bit 0 : Specifies output status of EX-OUT1 during communication shut-down after EtherCAT communication is established. (*) 0: Hold 1: Initialized (Output when EX-OUT1 is 0.) (*)ESM state is more than PreOP.</p> <p>bit 1-3: For manufacturer's use Permanently set at 0.</p> <p>bit 4 : For manufacturer's use Permanently set at 1.</p> <p>bit 5 : The correction function for detection delay of latch position. 0:The correction time of both the latch signal rising edge detection and the latch signal falling edge detection is set by Pr7.09 1:The correction time of the latch signal rising edge detection is set by Pr7.09, the correction time of the latch signal falling edge detection is set by Pr7.92. *Internal values are cleared at the timing during deceleration, stop, or safety state in response to the drive disable input when the servo is off.</p> <p>bit 6 : For manufacturer's use Permanently set at 0.</p> <p>bit 7 : Internal value state selection of objects 60B2h(Torque offset) in servo-off(Fall prevention function in the event of Servo-ON) 0: Clear 1: Updated with the set value of 60B2h</p> <p>bit 8-10 : For manufacturer's use Permanently set at 0.</p> <p>bit11: The setting condition of 6041h bit12(drive follows command value). 0 : Limiting torque and speed limit (only cst) is included. 1 : Limiting torque and speed limit (only cst) is not included.</p> <p>bit12-13 : For manufacturer's use Permanently set at 1.</p> <p>bit 14-15: For manufacturer's use All bits permanently set at 0.</p>	C	All	2-2 6-3-6 EtherCAT Spec.
	39	For manufacturer's use	—	—	2	Permanently set at 0.	—	—	—
	40	Station alias setting (high)	—	0-255	2	Define the higher 8 bits of station alias.	R	All	EtherCAT Spec.
	41	Station alias selection	—	0-2	2	Select the setting origin of a station alias. 0 : RSW(lower)+Pr7.40(higher) 1 : SII 2 : For manufacturer's use	R	All	EtherCAT Spec.
	42	Maximum continuation communication error	—	-32768 - 32767	2	Set up the maximum of times of continuation communication error occurrence. bit0-3 : Err80.7 detection threshold bit4-7 : (Reserved) bit8-11 : (Reserved) bit12-15 : (Reserved)	R	All	EtherCAT Spec.
	43	Lost link detection time	ms	0-32767	2	An ESM state after Init->PreOP changes, When either Port0 or Port1 carries out this parameter setup time progress in the state (Port which is Lost link removes from an Init->PreOP changes time) where it was set to Lost link, Err85.2 "Lost link detection unusual protection" occurs. When 0 is set up, detection of Err85.2 "Lost link detection unusual protection" is disabled.	R	All	EtherCAT Spec.

(To be continued)

Class	No.	Title	Unit	Range	Size [byte]	Function / Contents	Attribute	Related control mode	Reference
7	44	Software version	—	-2147483648-2147483647	4	The software versions 1 and 2 of a product are displayed. bit 31-28:Reserved(Permanently set at 0) bit 27-16:Software version 1 (in hexadecimal three-digit notation) bit 15-12:Reserved(Permanently set at 0) bit 11-0:Software version 2 (in hexadecimal three-digit notation) For example, in the case of Software version 1: 1.23 and Software version 2: 4.56, the value of this parameter will be 01230456h (19072086).	X	All	EtherCAT Spec.
	78*2)	For manufacturer's use	—	—	2	Permanently set at 0.	—	—	—
	79	For manufacturer's use	—	—	2	Permanently set at 0.	—	—	—
	80*2)	Function expansion setup 8	—	-32768 ~32767	2	Sets each communication functions by bit unit. bit0-5 : For manufacturer's use All bits permanently set at 0. bit6 : Extended configuration for 6041h bit12(homing attained) 0:Setting at the start of homing return operation (hm only) 1:Setting at the time of switching of homing return position control mode (hm only) bit7-15 : For manufacturer's use All bits permanently set at 0.	C	—	—
	87	Communication function extended setup 5	—	-32768 ~ 32767	2	bit 0-9: For manufacturer's use All bits permanently set at 0. bit 10-11: For manufacturer's use All bits permanently set at 1. bit 12: For manufacturer's use Fix at 0. bit13:The setting condition of 6041h bit12(drive follows command value).1*) 0:POT/NOT signal detection (only csp) is included. 1:POT/NOT signal detection (only csp) is not included. bit 14-15: For manufacturer's use All bits permanently set at 0.	C	All	—
92	Correction time of latch delay 2	25ns	-2000 ~ 2000	2	Set the correction time for delay of the latch trigger signal detection. This parameter can be switched by Pr7.24 bit5. bit5 is 0: Invalid bit5 is 1: The correction time is reflected in the latch signal falling edge detection. *Signal state of edge detection means the following The rising edge detection means the photocoupler is turned ON. The falling edge detection means the photocoupler is turned OFF.	B	All	EtherCAT Spec.	
93	Homing return speed limit value	r/min	0 ~ 20000	2	Sets the Homing return limit speed. When the set value is less than the internal minimum speed, it is limited by the internal minimum speed. When setting value is greater than the maximum motor speed, it will be limited by the maximum motor speed. (Note) The value is converted into [command unit/s] during internal computation. The converted value is limited within the following range. 00000001h to 7FFFFFFFh (1 to 2147483647) If 0 is set for this parameter, 1 is internally set for control.	C	All	EtherCAT Spec.	

*1) It is not supported by the software versions of function extended version 7 or earlier.

*2) It is not supported in versions corresponding to function extended edition 8 or earlier.
(To be continued)

Class	No.	Title	Unit	Range	Size [byte]	Function / Contents	Attribute	Related control mode	Reference
7	99	Communication function extended setup 6	—	-32768 – 32767	2	bit0: Activation of operation command (test run, FFT, etc.) execution by USB communication (PANATERM) when EtherCAT communication is established: 0: Invalid 1: Valid bit1-2: For manufacturer's use All bits permanently set at 0. bit3: Command pulse accumulation value [command unit] output setting 0: Before filter 1: After filter bit4-15: For manufacturer's use All bits permanently set at 0.	B	All	EtherCAT Spec.
	100	For manufacturer's use	—	—	2	Permanently set at 0.	—	—	—
	101	For manufacturer's use	—	—	4	Permanently set at 0.	—	—	—
	102	For manufacturer's use	—	—	4	Permanently set at 0.	—	—	—
	103	For manufacturer's use	—	—	4	Permanently set at 0.	—	—	—
	104	For manufacturer's use	—	—	4	Permanently set at 0.	—	—	—
	108	For manufacturer's use	—	—	2	Permanently set at 7.	—	—	—
	109	For manufacturer's use	—	—	2	Permanently set at 0.	—	—	—

(To be continued)

Class	No.	Title	Unit	Range	Size [byte]	Function / Contents	Attribute	Related control mode	Reference
7	110	For manufacturer's use	—	-2147483648-2147483647	4	Sets each communication functions by bit unit. bit0-6 For manufacturer's use, Fix at 0. bit7 Err80.7 enhancement 1*) 0:Invalid 1:Valid bit8 Err80.3 enhancement 1*) 0:Invalid 1:Valid bit9-31 For manufacturer's use, Fix at 0.	B	All	EtherCAT Spec.
	113	Torque offset filter	0.01 ms	0-6400	2	Set up the time constant of the 1st delay filter for torque offset(60B2h).	B	All	—
	120	Absolute scale offset 1	pulse (Feedback scale, higher 32 bits)	-2147483648 ~ 2147483647	4	When performing the return to the point of origin in the absolute mode, the amplifier automatically sets up the difference (offset value) between the encoder 0 position (or feedback scale 0 position) and the origin detection position so that 6063h will be 0 at that position after the position of origin has been detected. *2) It corresponds to the encoder multi-rotation data or the higher 32 bits of the 64-bit (consisting of the higher 24-bit + lower 24-bit data) data of the feedback scale. Do not manually change this parameter, which otherwise causes the position of origin to change. *3) This parameter is invalid in increment mode (Pr0.15=1). In full-closed control, this parameter is valid only when the serial communication type is of absolute specification (Pr3.23=2).	R	All	—
	121	Absolute scale offset 2	pulse (Feedback scale, lower 32 bits)	-2147483648 ~ 2147483647	4	When performing the return to the point of origin in the absolute mode, the amplifier automatically sets up the difference (offset value) between the encoder 0 position (or feedback scale 0 position) and the origin detection position so that 6063h will be 0 at that position after the position of origin has been detected. *2) It corresponds to the encoder 1-rotation data or the lower 32 bits of the 64-bit (consisting of the higher 24-bit + lower 24-bit data) data of the feedback scale. Do not manually change this parameter, which otherwise causes the position of origin to change. *3) This parameter is invalid in increment mode (Pr0.15=1). In full-closed control, this parameter is valid only when the serial communication type is of absolute specification (Pr3.23=2).	R	All	—

*1) It is not supported by the software versions of function extended version 7 or earlier.

*2) Only this parameter is automatically saved to EEPROM after the setting.

*3) If you want to reset the position of origin to its initial state, manually set 0 up on this object and write it to EEPROM.
Change both Pr7.120 and Pr7.121 to 0.
Behavior is not guaranteed if a value other than 0 is set manually.
Manually set values take effect if the control power is repowered on.

9-1-9 Class 8: Special setting 3

Class	No.	Title	Unit	Range	Size [byte]	Function / Contents	Attribute	Related control mode	Reference
8	00	For manufacturer's use	—	—	2	Permanently set at 0.	—	—	—
	01	Profile linear acceleration constant	10000 command unit/s ²	1-429496	4	Set the acceleration of retracting operations. Make sure that this is set before retracting operation activation.	B	All	6-7
	02	For manufacturer's use	—	—	2	Permanently set at 0.	—	—	—
	03	For manufacturer's use	—	—	2	Permanently set at 0.	—	—	—
	04	Profile linear deceleration constant	10000 command unit/s ²	1-429496	4	Set the deceleration of retracting operations. Make sure that this is set before retracting operation activation.	B	All	6-7
	05	For manufacturer's use	—	—	2	Permanently set at 0.	—	—	—
	10	For manufacturer's use	—	—	4	Permanently set at 0.	—	—	—
	12	For manufacturer's use	—	—	2	Permanently set at 0.	—	—	—
	13	For manufacturer's use	—	—	4	Permanently set at 0.	—	—	—
	14	For manufacturer's use	—	—	4	Permanently set at 0.	—	—	—
	15	For manufacturer's use	—	—	4	Permanently set at 0.	—	—	—
	17	Relative movement of retracting operation	Command unit	-2147483647 — 2147483647	4	Set the amount of movement at the time of retracting operation based on the pre-filter command position. If the movement amount is 0 after the processing by the electronic gear, after emergency stop, no retracting operation is performed and Err87.1 or Err87.2 occurs. Make sure that this is set before retracting operation activation. * This is a signed data, and thus caution is required on the direction of retracting operation.	B	All	6-7
	18	Retracting operation speed	Command unit/s	0- 2147483647	4	Set the speed of retracting operations. If 0 is set for this parameter, 1 is set internally. The maximum value is set internally to a smaller value between 6080h (Max motor speed) and the maximum motor speed. Make sure that this is set before retracting operation activation.	B	All	6-7
	19	For manufacturer's use	—	—	2	Permanently set at 0.	—	—	—

9-1-10 Class 9: Linear-related

Class	No	Title	Unit	Range	Size [byte]	Function/Contents	Attribute	Related control mode	Reference
9	00	Motor type selection	—	0-3	2	Select the type of a motor that will be connected. 1: Linear type 2: Rotary type 3: Linear (VCM)	R	All	4-7
	01	Feedback scale resolution	nm	0-536870912	4	[Motor type (linear) , linear (VCM)] Set up the resolution for the feedback scale.	R	All	4-7
		Number of scalepulses per rotation	pulse			[Motor type (Rotary)] Set the number of pulses of the feedback scale per revolution.			
	02	Magnet pole pitch	0.01 mm	0-32767	2	[Motor type (Linear)] Set up the magnet pole pitch. * No setting is required in the case of rotary or linear (VCM).	R	All	4-7
	03	Pole logarithm per rotation	Pole pairs	0-255	2	[Motor type (Rotary)] Set up the pole logarithm per motor rotation for the motor. * No setting is required in the case of linear or linear (VCM).	R	All	4-7
	04	Mass of motor's movable section	0.01 kg	0-32767	2	[Motor type (Linear) , linear (VCM)] Set up the moving portion's mass of motor.	R	All	4-7
		Motor inertia	0.00001 kgm ²			[Motor type (Rotary)] Set up the motor inertia.			
	05	Rated motor thrust	0.1 N	0-32767	2	[Motor type (Linear) , linear (VCM)] Set up the rated thrust for the motor.	R	All	4-7
		Rated motor torque	0.1 Nm			[Motor type (Rotary)] Set up the rated torque for the motor.			
	06	Rated effective motor current	0.1 Arms	0-32767	2	[Motor type: Linear, rotary] Sets the rated effective current of the motor.	R	All	4-7
			0.1A			[Motor type: Linear (VCM)] Sets the rated current of the motor.			
	07	Maximum instantaneous motor current	0.1 A	0-32767	2	Set up the maximum instantaneous current for the motor.	R	All	4-7
	08	Motor phase inductance	0.01 mH	0-32767	2	Set up the phase inductance for the motor.	R	All	4-7
	09	Motor phase resistance	0.01 Ω	0-32767	2	Set up the phase resistance for the motor.	R	All	4-7
	10	Maximum over-speed level	mm/s r/min	0-20000	2	Set up the maximum over-speed for the motor.	R	All	4-7
	11	Carrier frequency selection	—	0-3	2	Select the carrier frequency. 0: 6 kHz, 1: 12 kHz, 2: 8 kHz, 3: For manufacturer's use	R	All	4-7
	12	Automatic current response adjustment	%	0-100	2	Set up the criteria for current response for the automatic setup of Pr 9.13 "Proportional current gain" and Pr 9.14 "Integral current gain".	R	All	4-7
	13	Proportional current gain	—	0-32767	2	Set up the proportional current gain.	B	All	4-7
	14	Integral current gain	—	0-32767	2	Set up the integral current gain.	B	All	4-7
17	For manufacturer's use	—	—	—	Always set to 0.	—	—	—	
18	For manufacturer's use	—	—	—	Always set to 0.	—	—	—	
19	For manufacturer's use	—	—	—	Always set to 0.	—	—	—	

(To be continued)

Class	No	Title	Unit	Range	Size [byte]	Function/Contents	Attribute	Related control mode	Reference
9	20	Magnet pole detection scheme selection	—	0-3	2	Select the detection scheme for magnet pole position.	R	All	4-7
	21	CS phase setup	Electrical angle (°)	0-360	2	Set up the phase difference between the induced voltage of the motor and CS signal.	R	All	4-7
	22	Magnet pole Position estimation thrust command time	ms	0-200	2	Set up the command thrust time for Magnet pole position estimation.	B	All	4-7
	23	Magnet pole position estimation command thrust	%	0-300	2	Set up the command thrust for magnet pole position estimation	B	All	4-7
	24	Magnet pole position estimation zero travel pulse width setup	pulse	0-32767	2	Set up the zero travel pulse width for magnet pole position estimation.	B	All	4-7
	25	Number of pulses for magnet pole position estimation motor stop judgment	pulse	0-32767	2	Set up the number of pulses for motor stop judgment for magnet pole position estimation	B	All	4-7
	26	Time for magnet pole position estimation motor stop judgment	ms	0-32767	2	Set up the motor stop judgment time for magnet pole position estimation.	B	All	4-7
	27	Time for magnet pole position estimation motor stop limitation	ms	0-32767	2	Set up the motor stop limitation time for magnet pole position estimation.	B	All	4-7
	28	Magnet pole position estimation thrust command filter	0.01 ms	0-2500	2	Set up the time constant for filter respective to the command thrust for magnet pole position estimation.	B	All	4-7
	29	Overload protection time characteristics selection	—	0-7	2	Setup value 0: According to standard specifications Select the overload protection time characteristics from eight types of characteristics.	R	All	7-2
	30	Number of pulses per magnet pole	pulse	0-3276700	4	Linear motor information can be set in pulses, which is valid for linear-type settings. This parameter cannot be used at the same time with Pr 9.02 (Magnetpole pitch). Use either of these parameters for setting	R	All	4-7
	31	For manufacturer's use	—	—	2	Always set to 0.	—	—	—
	32	For manufacturer's use	—	—	2	Always set to 0.	—	—	—
	33	For manufacturer's use	—	—	2	Always set to 100.	—	—	—
	34	For manufacturer's use	—	—	2	Always set to 0.	—	—	—
48	Voltage feed forward gain 1	—	0-32767	2	Set a Voltage feed forward gain 1. The higher the setting, the higher the current response to the change in torque command becomes. However, since it may cause oscillation or any other faulty operation, select an appropriate value according to the operating conditions. There is no compatibility with the automatic setting by the use of Pr9.12.	B	All	4-7	
49	Voltage feed forward gain 2	—	0-32767	2	Set a Voltage feed forward gain 2. The higher the setting, the higher the current response to torque command. However, since it may cause oscillation or any other faulty operation, select an appropriate value according to the operating conditions. There is no compatibility with the automatic setting by the use of Pr9.12.	B	All	4-7	
50	For manufacturer's use	—	—	—	Always set to 0.	—	—	—	

9-1-11 Class 15: For manufacturer's use

Class	No.	Title	Unit	Range	Size [byte]	Function / Contents	Attribute	Related control mode	Reference
15	00	For manufacturer's use	-	-	2	Permanently set at 0.	-	-	-
	02	For manufacturer's use	-	-	2	Permanently set at 0.	-	-	-
	16	For manufacturer's use	-	-	2	Permanently set at 2.	-	-	-
	17	For manufacturer's use	-	-	2	Permanently set at 4.	-	-	-
	30	For manufacturer's use	-	-	2	Permanently set at 0.	-	-	-
	31	For manufacturer's use	-	-	2	Permanently set at 5.	-	-	-
	33	For manufacturer's use	-	-	2	Permanently set at 0.	-	-	-
	34	For manufacturer's use	-	-	2	Permanently set at 0.	-	-	-
	35	For manufacturer's use	-	-	2	Permanently set at 1.	-	-	-

Note) Class 15 cannot be referred to in EtherCAT communication.

9-2 Timing Chart

9-2-1 Servo-on signal accept timing on power-up : When magnet pole position estimation is invalid (Pr9.20=2)

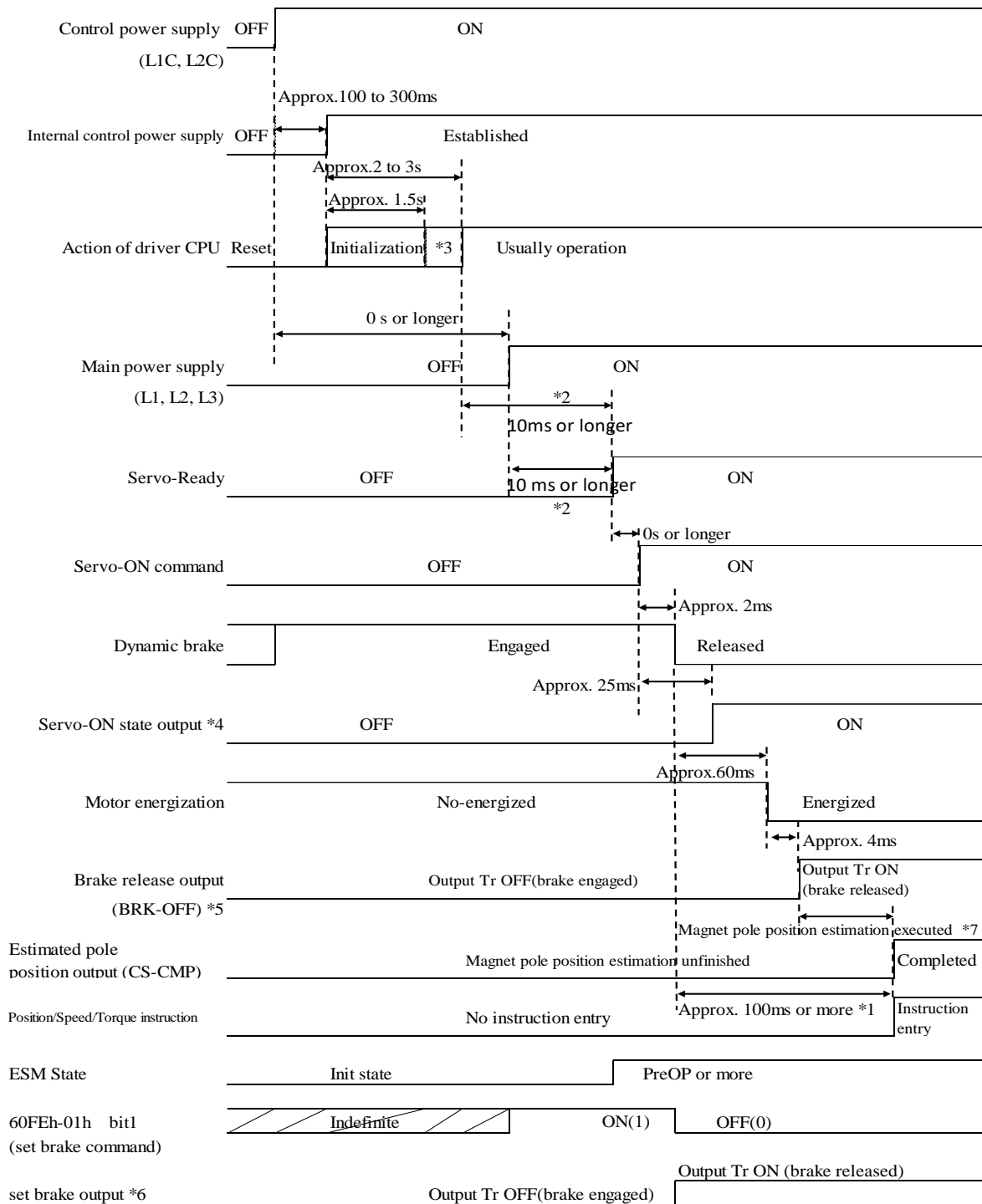

- The above chart shows the timing from AC power-ON to command input.
- Input the servo-On command, position/velocity/torque commands according to the above timing chart.

- *1. It is shown that an instruction input receptionist is not ready in this section. Please input instructions after the completion of preparation.
- *2. The servo ready is turned on when all the following conditions are satisfied: “Initialization of microcomputer is completed”, “Main power supply is established”, “No alarm is issued”, and “EtherCAT communication is established”.
- *3. After Internal control power supply, protective functions are active from approx. 1.5 sec after the start of initializing microcomputer. Please set the signals, especially for protective function, for example over-travel inhibit input (POT, NOT) or external scale input, so as to decide their logic until this term. The lapse time can be changed with Pr 6.18 Power-up wait time.

- *4. Note that the servo-on status output (SRV-ST) signal is to let you know of the receipt of servo-on command (SRV-ON) and is not an output to let you know that command input is possible.
- *5. A brake release output (BRK-OFF) is different from the set brake of 60FEh via EtherCAT communication.
- *6. The set brake output is output controlled by the set brake of 60FEh via EtherCAT communication. For information on the set brake output details, refer to the section 6-9-3 in the Technical Reference EtherCAT Communication Specification (SX-DSV03307).
The set brake output can be released in the servo-off state. Therefore, please control the set brake output in consideration of safety.
- *7. Time for magnet pole position estimation depends on parameter settings. Check that the magnet pole position estimation completion output will turn ON and then apply the command. If magnet pole position estimation has not completed correctly, the magnet pole position estimation completion output will not turn ON.

9-2-2 Servo-on signal accept timing on power-up: When magnet pole position estimation is invalid (Pr 9.20 = 0, 1, 3)

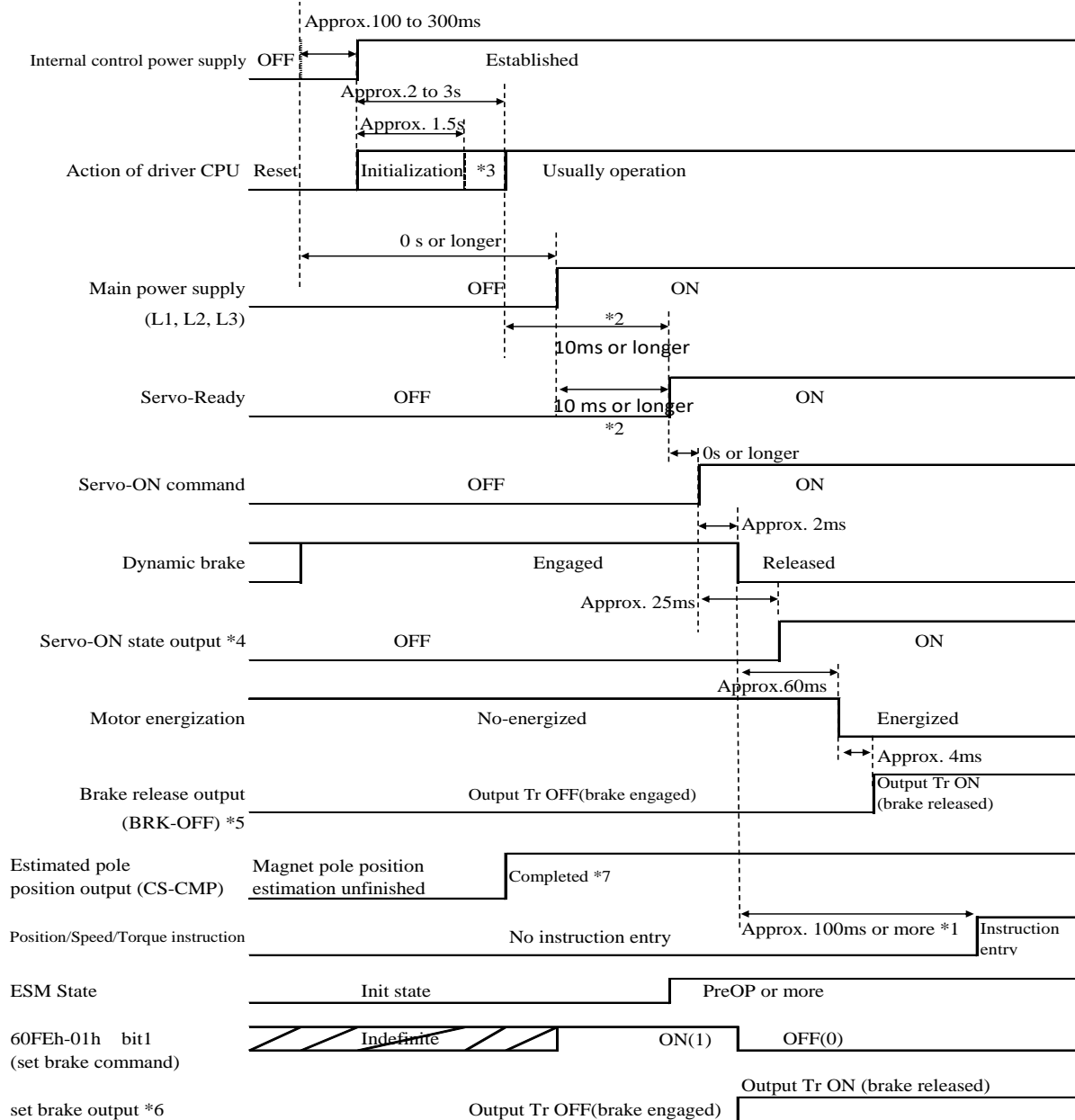

- The above chart shows the timing from AC power-ON to command input.
 - Input the servo-On command, position/velocity/trque commands according to the above timing chart.
- *1. It is shown that an instruction input receptionist is not ready in this section.
Please input instructions after the completion of preparation.
- *2. The servo ready is turned on when all the following conditions are satisfied: “Initialization of microcomputer is completed”, “Main power supply is established”, “No alarm is issued”, and “Synchronization (phase matching) between EtherCAT communication and servo is completed and EtherCAT communication is established”.
- *3. After Internal control power supply, protective functions are active from approx. 1.5 sec after the start of initializing microcomputer. Please set the signals, especially for protective function, for example over-travel inhibit input (POT, NOT) or feedback scale input, so as to decide their logic until this term. The lapse time can be changed with Pr 6.18 “Wait time after power-up”.
- *4. Note that the servo-on status output (SRV-ST) signal is to let you know of the receipt of servo-on command (SRV-ON) and is not an output to let you know that command input is possible.
- *5. A brake release output (BRK-OFF) is different from the set brake of 60FEh via EtherCAT communication.

- *6. The set brake output is output controlled by the set brake of 60FEh via EtherCAT communication.
For information on the set brake output details, refer to the section 6-9-3 in the Technical Reference EtherCAT Communication Specification (SX-DSV3307).
The set brake output can be released in the servo-off state. Therefore, In consideration of safety, please control the set brake output.
- *7. If Err 61.2 “Magnet pole position estimation error 3 protection” is activated or with Pr 9.20 = 0, the magnet pole position estimation completion output will not turn ON. The timing (condition) at which the magnet pole position estimation completion output turns ON depends on the setup value for Pr 9.20 “Magnet pole detection scheme selection”. For more information, refer to Section 2-2

9-2-3 Servo-ON/OFF action while the motor is at stall (servo-lock)

(To turn on/off the servo during normal operation, first stop the motor.)

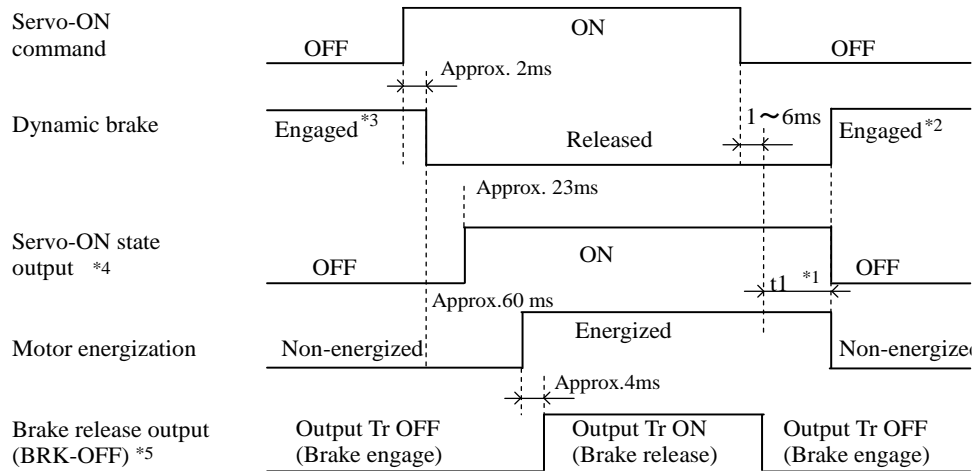

- *1. t_1 depends on the setup value of Pr 4.37 (Mechanical brake action at stalling setup).
- *2. The operation of dynamic brake during servo off depends on the setup value of Pr 5.06 (Sequence at Servo-Off).
- *3. Servo-ON will not be activated until the motor speed falls below approx. 30 r/min.
- *4. Note that the servo-on status output (SRV-ST) signal is to let you know of the receipt of servo-on command (SRV-ON) and is not an output to let you know that command input is possible.
- *5. A brake release output (BRK-OFF) is different from the set brake of 60FEh via EtherCAT communication. For information on the set brake output details, refer to the section 6-9-3 in the Technical Reference EtherCAT Communication Specification (SX-DSV03307).

9-2-4 Servo-ON/OFF action while the motor is in motion

(Timing at emergency stop or trip. Do not repeat this sequence.)

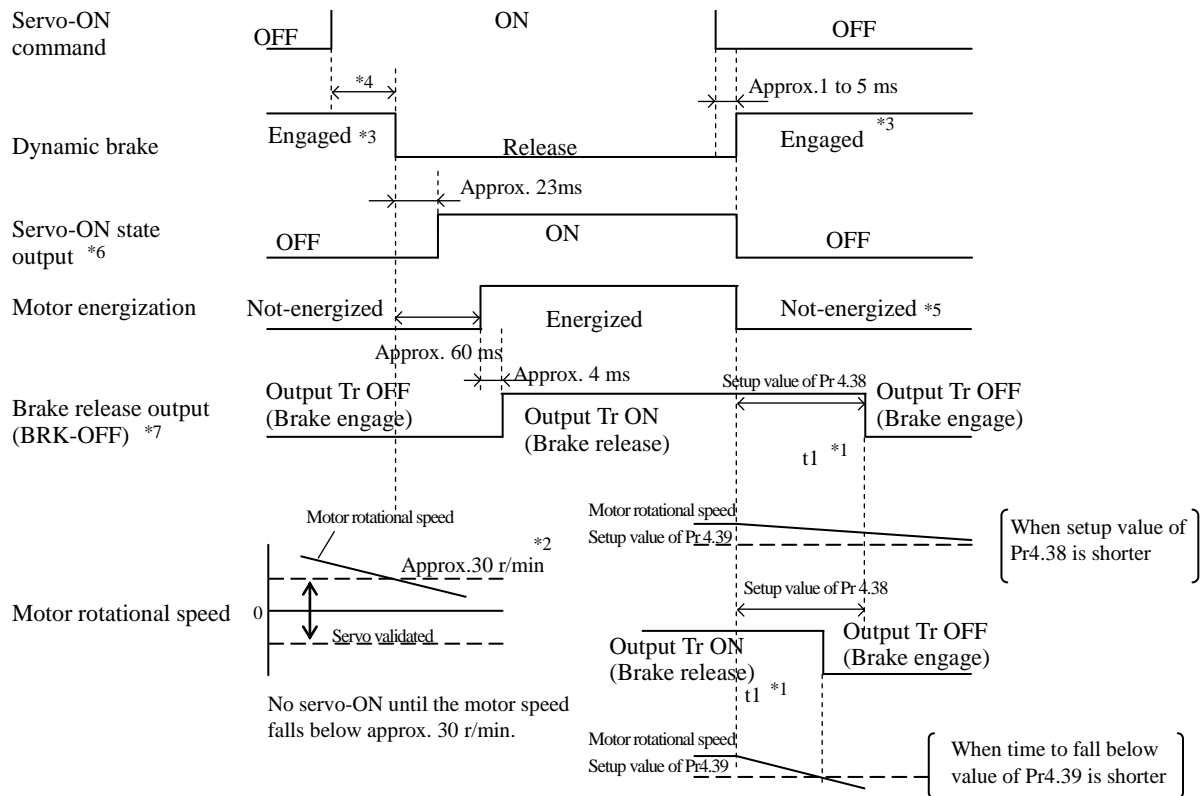

- *1. $t1$ will be a shorter time of either the setup value of Pr 4.38 (Mechanical brake action at running setup) or elapsing time for the motor speed to fall below Pr 4.39 (Brake release speed setup).
- *2. Even when the servo-ON command is turned on again while the motor is decelerating, transition to servo-ON is not performed until the motor stops.
- *3. For the action of dynamic brake at servo-OFF, refer to an explanation of Pr 5.06 (Sequence at Servo-Off) as well.
- *4. Servo-ON will not be activated until the motor speed falls below approx. 30 r/min.
- *5. For the motor energization during deceleration at Servo-OFF depends on the setup value of Pr 5.06 (Sequence at Servo-Off).
- *6. Note that the servo-on status output (SRV-ST) signal is to let you know of the receipt of servo-on command (SRV-ON) and is not an output to let you know that command input is possible.
- *7. A brake release output (BRK-OFF) is different from the set brake of 60FEh via EtherCAT communication. For information on the set brake output details, refer to the section 6-9-3 in the Technical Reference EtherCAT Communication Specification (SX-DSV03307).

9-2-5 When an error (alarm) has occurred (at Servo-ON command) (DB/Free run deceleration movement)

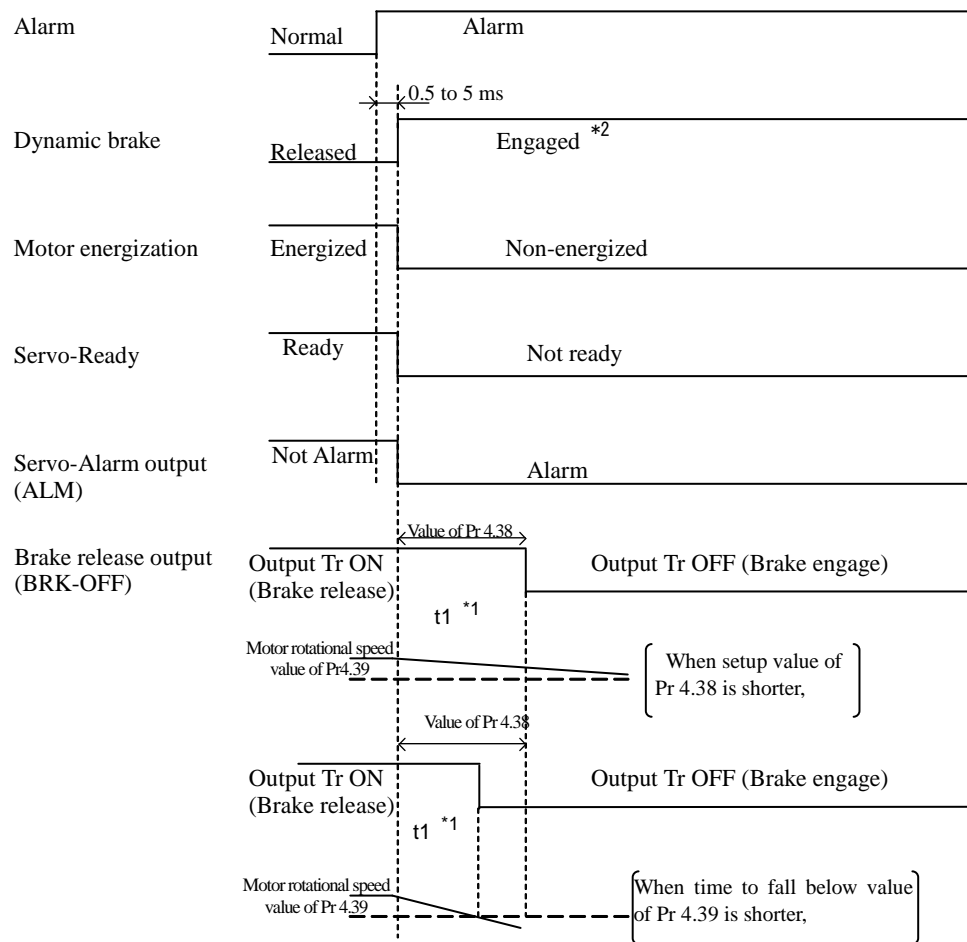

• Timing of the figure above changes in the setting of various sequence operation.

- *1. $t1$ will be a shorter time of either the setup value of Pr 4.38 (Mechanical brake action at running setup) or elapsing time for the motor speed to fall below Pr 4.39 (Brake release speed setup).
- *2. When an alarm is generated, the dynamic brake operates according to Pr 5.10 (Sequence at alarm).
- *3. A brake release output (BRK-OFF) is different from the set brake of 60FEh via EtherCAT communication. For information on the set brake output details, refer to the section 6-9-3 in the Technical Reference EtherCAT Communication Specification (SX-DSV03307).

9-2-6 When an error (alarm) has occurred (at Servo-ON command) (Emergency stop movement)

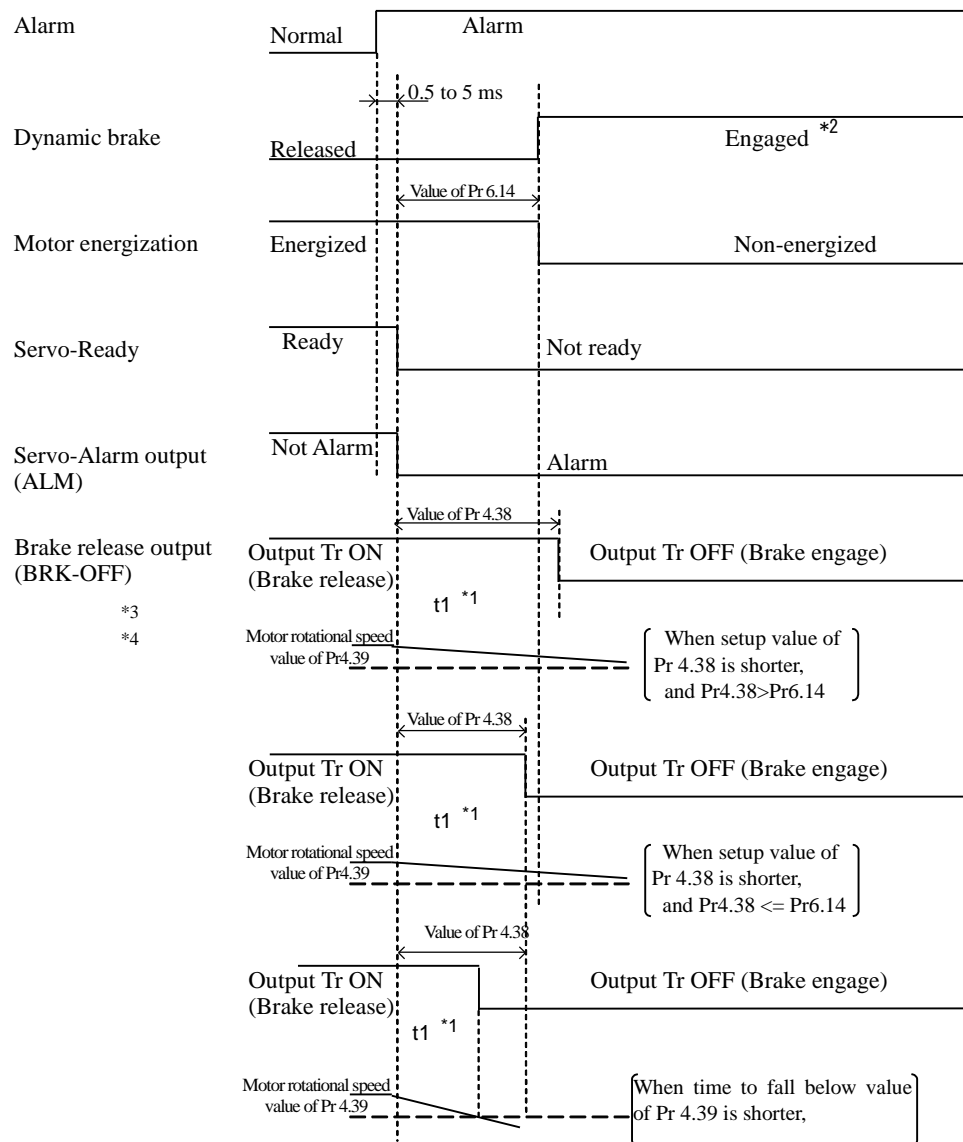

• For the operation timing when the Slow Stop function is valid, refer to section 6-3-7.

• Timing of the figure above changes in the setting of various sequence operation.

- *1. t1 will be a shorter time of either the setup value of Pr 4.38 (Mechanical brake action at running setup) or elapsing time for the motor speed to fall below Pr 4.39 (Brake release speed setup).
- *2. When an alarm is generated, the dynamic brake operates according to Pr 5.10 (Sequence at alarm).
- *3. A brake release output (BRK-OFF) is different from the set brake of 60FEh via EtherCAT communication. For information on the set brake output details, refer to the section 6-9-3 in the Technical Reference EtherCAT Communication Specification (SX-DSV03307).
- *4. We recommend the setting in which Pr4.38 (Mechanical brake action at running setup) becomes equal to Pr6.14 (Emergency stop time at alarm).
If Pr4.38 is set to less than or equal to Pr6.14, the brake operates after the length of time set for Pr4.38 elapses. If Pr4.38 is set to greater than Pr6.14, the brake does not operate after the length of time set for Pr4.38 elapses, but the brake operates at the time of transition to non-energizing.

9-2-7 When an alarm has been cleared (at Servo-ON command)

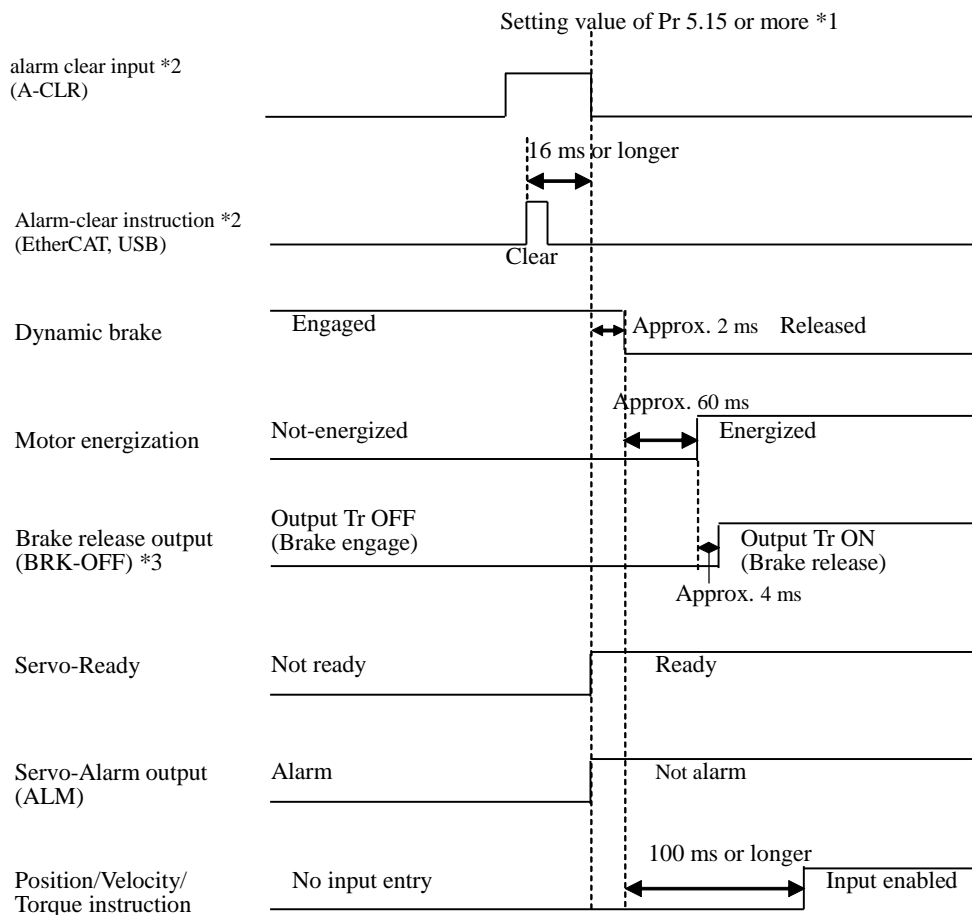

- *1. The length of time for identifying alarm clear input is the length of time set for Pr5.15.
- *2. When clearing an alarm from EtherCAT communication or USB communication(PANATERM), turn OFF alarm clear input (A-CLR) once.
- *3. A brake release output (BRK-OFF) is different from the set brake of 60FEh via EtherCAT communication. For information on the set brake output details, refer to the section 6-9-3 in the Technical Reference EtherCAT Communication Specification (SX-DSV03307).